



TEX100LCD/S

USER MANUAL
VOLUME 1



File Name: TEX100LCD_ENG_2.2.indb

Version: 2.2

Date: 24/03/2023

Revision History

Date	Version	Reason	Editor
26/06/2019	2.0	Second Version	J. H. Berti
06/07/2020	2.1	Technical Specification Upgrade	J. H. Berti
24/03/2023	2.2	Options Upgrade	J. H. Berti

TEX100LCD/S - User Manual
Version 2.2

© Copyright 2019 - 2023

R.V.R. Elettronica S.r.l.

Via del Fonditore 2/2c - 40138 - Bologna (Italia)

Telephone: +39 051 6010506

Fax: +39 051 6011104

Email: info@rvr.it

Web: www.rvr.it

All rights reserved

Printed and bound in Italy. No part of this manual may be reproduced, memorized or transmitted in any form or by any means, electronic or mechanic, including photocopying, recording or by any information storage and retrieval system, without written permission of the copyright owner.

Notification of intended purpose and limitations of product use

This product is a FM transmitter intended for FM audio broadcasting. It utilizes operating frequencies not harmonised in the intended countries of use. The user must obtain a license before using the product in intended country of use. Ensure respective country licensing requirements are complied with. Limitations of use can apply in respect of operating frequency, transmitter power and/or channel spacing.

Declaration of Conformity

Hereby, R.V.R. Elettronica, declares that this FM transmitter is in compliance with the essential requirements and other relevant provisions of Directive 2014/53/EU.



Technical Specifications

		TEX100LCD/S		
Parameters		U.M.	Value	Notes
GENERALS				
Frequency range		MHz	87.5 + 108	
Rated output power		W	100	Continuously variable by software from 0 to maximum
Modulation type			F3E Direct carrier frequency	
Operational Mode			Mono, Stereo, Multiplex	
Working temperature		°C	-5 to + 50	
Working Humidity		%	95 (Without condensing)	
Working Altitude		mt	3000	With adequate air evacuation system in site
Frequency programmability			From software, with 10 kHz steps	
Frequency stability	Working Temp. from -5°C to 50°C	ppm	±1	
Modulation capability		kHz	150 Stereo, 180 Mono/MPX	Meets or exceeds all FCC and CCIR rules
Pre-emphasis mode		µS	0, 50 (CCIR), 75 (FCC)	selectable by rear panel dip switches
Spurious & harmonic suppression		dBc	<75 (80 typical)	Meets or exceeds all FCC and CCIR rules
Asynchronous AM S/N ratio	Referred to 100% AM, with no de-emphasis	dB	≥ 65 (typical 70)	
Synchronous AM S/N ratio	Referred to 100% AM, FM deviation 75 kHz by 400Hz sine, without de-emphasis	dB	≥ 50 (typical 60)	
MONO OPERATION				
S/N FM Ratio	RMS @ ± 75 kHz peak, HPF 20Hz - LPF 23 kHz, 50 µS de-emphasis	dB	> 80 (typical 85)	
	Qpk @ ± 75 kHz peak, CCIR weighted, 50 µS de-emphasis	dB	>73	
	Qpk @ ± 40 kHz peak, CCIR weighted, 50 µS de-emphasis	dB	>68	
Frequency Response	30Hz + 15kHz	dB	better than ± 0.5 dB (typical ± 0.2)	
Total Harmonic Distortion	THD+N 30Hz + 15kHz	%	< 0.1 (Typical 0.07%)	
Intermodulation distortion	Measured with a 1 KHz, 1.3 KHz tones, 1:1ratio, @ 75 kHz FM	%	< 0.05	
Transient intermodulation distortion	3.18 kHz square wave, 15 kHz sine wave @75 kHz FM	%	< 0.1 (typical 0.05)	
MPX OPERATION				
Composite S/N FM Ratio	RMS @ ± 75 kHz peak, HPF 20Hz - no LPF, 50 µS de-emphasis	dB	> 80 (typical 85)	
Frequency Response	30Hz + 53kHz	dB	± 0.2	
	53kHz + 100kHz	dB	± 0.5	
Total Harmonic Distortion	THD+N 30Hz + 53kHz	%	< 0.1	
	THD+N 53kHz + 100kHz	%	< 0.15	
Intermodulation distortion	Measured with a 1 KHz, 1.3 KHz tones, 1:1ratio, @ 75 kHz FM	%	< 0.05	
Transient intermodulation distortion	3.18 kHz square wave, 15 kHz sine wave @75 kHz FM	%	< 0.1 (typical 0.05)	
Stereo separation	30Hz + 53kHz	dB	> 50 dB (typical 60)	
STEREO OPERATION				
Stereo S/N FM Ratio	RMS @ ± 75 kHz peak, HPF 20Hz - LPF 23 kHz, 50 µS de-emphasis, L & R demodulated	dB	> 75 (78 typical)	
	Qpk @ ± 75 kHz peak, CCIR weighted, 50 µS de-emphasis, L & R demodulated	dB	> 65 dB	
	Qpk @ ± 40 kHz peak, CCIR weighted, 50 µS de-emphasis, L & R demodulated	dB	> 58 dB	
Frequency Response	30Hz + 15kHz	dB	± 0.5	
Total Harmonic Distortion	THD+N 30Hz + 15kHz	%	< 0.05	
Intermodulation distortion	Measured with a 1 KHz, 1.3 KHz tones, 1:1ratio, @ 75 kHz FM	%	≤ 0.03	
Transient intermodulation distortion	3.18 kHz square wave, 15 kHz sine wave @75 kHz FM	%	< 0.1 (typical 0.05)	
Stereo separation		dB	> 50 (typical 55)	
Main / Sub Ratio	30Hz + 15kHz	dB	> 40 (typical 45)	
SCA OPERATION				
Frequency response	40kHz + 100kHz	dB	± 0.5	
Crosstalk to main or to stereo channel	RMS, ref @ ± 75 kHz peak, no HPF/LPF, 0µS de-emphasis, with 67 kHz tone on SCA input @ 7,5kHz FM deviation	dB	> 75 (typical 78)	
	RMS, ref @ ± 75 kHz peak, no HPF/LPF, 0µS de-emphasis, with 92 kHz tone on SCA input @ 7,5kHz FM deviation	dB	> 78 (typical 80)	
POWER REQUIREMENTS				
AC Power Input	AC Supply Voltage	VAC	80 + 260	(*) Internal switch (**) monophase (***) Threephases Y
	AC Apparent Power Consumption	VA	330	
	Active Power Consumption	W	212	
	Power Factor		0,6	
	Overall Efficiency	%	47	
	Connector			VDE IEC Standard
DC Power Input	DC Supply Voltage	VDC	28	
	DC Current	ADC	8,2 (**)	(*)max 25W (**) max 140W
MECHANICAL DIMENSIONS				
Physical Dimensions	Front panel width	mm	483 (19")	19" EIA rack
	Front panel height	mm	88 (3 1/2") 2HE	convertire in pollici
	Overall depth	mm	394	
	Chassis depth	mm	372	escluso il pannello, esclusi i connettori, convertire in pollici
Weight	kg		about 8.5	
VARIOUS				
Cooling			Forced, with internal fan	
Acoustic Noise		dBA	< 58	

AUDIO INPUTS				
Left / Mono	Connector		XLR F	
	Type		Balanced	
	Impedance	Ohm	10 k or 600	Selectable by rear panel dip switches
	Input Level / Adjust	dBu	-13 to +13	continuously variable
Right	Connector		XLR F	
	Type		Balanced	
	Impedance	Ohm	10 k or 600	Selectable by rear panel dip switches
	Input Level	dBu	-13 to +13	continuously variable
MPX	Connector		BNC	
	Type		unbalanced	
	Impedance	Ohm	10 k or 50	Selectable by rear panel dip switches
	Input Level / Adjust	dBu	*-13 to +13	for 7.5 KHz FM, externally adjustable
SCA/RDS	Connector		2 x BNC	
	Type		unbalanced	
	Impedance	Ohm	10 k	
	Input Level / Adjust	dBu	*-8 to +13	for 7.5 KHz FM, externally adjustable
AES/EBU (optional)	Connector		XLR F	
	Type		Balanced	
	Impedance	Ohm	110	
	Input Level / Adjust	dBfs	0 to -10	for 7.5 KHz FM, externally adjustable
TOS/Link (optional)	Connector		TOS-LINK	
	Type		Optical	
OUTPUTS				
RF Output	Connector		N type	
	Impedance	Ohm	50	
RF Monitor	Connector		BNC	
	Impedance	Ohm	50	
	Output Level	dB	approx. -60	Referred to the RF output
Pilot output	Connector		BNC	For RDS and isofrequency synchronizing purpose
	Impedance	Ohm	>5 k	
	Output Level	Vpp	1	
AUXILIARY CONNECTIONS				
Interlock	Connector		BNC	Input and output for remote power inhibition (short is RF off)
Service	Connector		DB9 F	Factory reserved for firmware program
Remote Interface	Connector		DB15F	IIC + 5 analog / digital inputs, 5 analog / digital outputs
FUSES				
On Mains			1 External fuse F 6,3 T - 5x20 mm	
On services				
On PA Supply				
On Driver Supply				
HUMAN INTERFACES				
Input device			4 pushbutton	
Display			Alphanumerical LCD - 2 x 16	
TELEMETRY / TELECONTROL				
Remote connector inputs	Analogical level	10	FWD fold	For P.A. A.G.C. purpose, min 0.5 Vcc
		2	REF fold	For P.A. A.G.C. purpose, min 0.5 Vcc
	Pulse to GND	14	RF ON	
		15	RF OFF	
		1	Interlock	for remote power inhibition (short is RF off)
Remote connector outputs	Analogical level	6	FWD	max 5 Vcc
		13	REF	max 5 Vcc
		5	VPA	max 5 Vcc
		12	IPA	max 5 Vcc
	Open Collector	7	Power Good	open collector

Table of Contents

1.	Preliminary Instructions	1
2.	Warranty	1
3.	First Aid	2
3.1	Treatment of electrical shocks	2
3.2	Treatment of electrical Burns	2
4.	General Description	3
4.1	Unpacking	3
4.2	Features	4
4.3	Frontal Panel Description	5
4.4	Rear Panel Description	6
4.5	Connectors Description	7
5.	Installation and use	8
5.1	Installation	9
5.2	Operation	19
5.3	Management Firmware	21
5.4	Optional Function	27
6.	Identification and Access to the Modules	29
6.1	Identification of the Modules	29
7.	Working Principles	30
7.1	Panel board	30
7.2	Main board	30
7.3	Telemetry board	31
7.4	Power Supply	31
7.5	Power Amplifier	31
7.6	Control Board	32
8.	Maintenance and repair procedures	33
8.1	Introduction	33
8.2	Security Considerations	33
8.3	Ordinary maintenance	33
9.	Option	34
9.1	/AUDIGIN-TEX option	34
9.2	/RDS-TEX2HE & /RDS-TEX-E-2HE option	35
9.3	/TLC-TEX2HE option	36
9.4	/TLM-TEX-E-2HE option	37
9.5	/TLW-TEX-E-2HE option	38
9.6	/TLW-TEX2HE Option	39
9.7	/RTC-TEX option	40
9.8	/FW2 option (only software)	40
9.9	UP/DOWN Power option (only software)	40

This page was intentionally left blank

IMPORTANT

The symbol of lightning inside a triangle placed on the product, evidences the operations for which is necessary gave it full attention to avoid risk of electric shocks.



The symbol of exclamation mark inside a triangle placed on the product, informs the user about the presence of instructions inside the manual that accompanies the equipment, important for the efficacy and the maintenance (repairs).

1. Preliminary Instructions

• General Warnings

This equipment should only be operated, installed and maintained by “trained” or “qualified” personnel who are familiar with risks involved in working on electric and electronic circuits. “Trained” means personnel who have technical knowledge of equipment operation and who are responsible for their own safety and that of other unqualified personnel placed under their supervision when working on the equipment.

“Qualified” means personnel who are trained in and experienced with equipment operation and who are responsible for their own safety and that of other unqualified personnel placed under their supervision when working on the equipment.

 **WARNING: Residual voltage may be present inside the equipment even when the ON/OFF switch is set to Off. Before servicing the equipment, disconnect the power cord or switch off the main power panel and make sure the safety earth connection is connected. Some service situations may require inspecting the equipment with live circuits. Only trained and qualified personnel may work on the equipment live and shall be assisted by a trained person who shall keep ready to disconnect power supply at need.**

R.V.R. Elettronica shall not be liable for injury to persons or damage to property resulting from improper use or operation by trained/untrained and qualified/unqualified persons.

 **WARNING: The equipment is not water resistant. Any water entering the enclosure might impair proper operation. To prevent the risk of electrical shock or fire, do not expose this equipment to rain, dripping or moisture.**

Please observe local codes and fire prevention rules when installing and operating this equipment.

 **WARNING: This equipment contains exposed live parts involving an electrical shock hazard. Always disconnect power supply before removing any covers or other parts of the equipment.**

Ventilation slits and holes are provided to ensure reliable operation and prevent overheating; do not obstruct or cover these slits. Do not obstruct the ventilation slits under any circumstances. The product must not be incorporated in a rack unless adequate ventilation is provided or the manufacturer’s instructions are followed closely.

 **WARNING: This equipment can radiate radiofrequency energy and, if not installed in compliance with manual instructions and applicable regulations, may cause interference with radio communications.**

 **WARNING: This equipment is fitted with earth connections both in the power cord and for the chassis. Make sure both are properly connected.**

Operation of this equipment in a residential area may cause radio interference, in which case the user may be required to take adequate measures.

The specifications and data contained herein are provided for information only and are subject to changes without prior notice. **R.V.R. Elettronica** disclaims all warranties, express or implied. While R.V.R. Elettronica attempts to provide accurate information, it cannot accept responsibility or liability for any errors or inaccuracies in this manual, including the products and the software described herein. **R.V.R. Elettronica** reserves the right to make changes to equipment design and/or specifications and to this manual at any time without prior notice.

• Notice concerning product intended purpose and use limitations.

This product is a radio transmitter suitable for frequency-modulation audio radio broadcasting. Its operating frequencies are not harmonised in designated user countries. Before operating this equipment, user must obtain a licence to use radio spectrum from the competent authority in the designated user country. Operating frequency, transmitter power and other characteristics of the transmission system are subject to restrictions as specified in the licence.

2. Warranty

La **R.V.R. Elettronica** warrants this product to be free from defects in workmanship and its proper operation subject to the limitations set forth in the supplied Terms and Conditions. Please read the Terms and Conditions carefully, as purchase of the product or acceptance of the order acknowledgement imply acceptance of the Terms and Conditions. For the latest updated terms and conditions, please visit our web site at WWW.RVR.IT. The web site may be modified, removed or updated for any reason whatsoever without prior notice. The warranty will become null and void in the event the product enclosure is opened, the product is physically damaged, is repaired by unauthorised persons or is used for purposes other than its intended use, as well as in the event of improper use, unauthorised changes or neglect. In the event a defect is found, follow this procedure:

- 1 Contact the seller or distributor who sold the equipment; provide a description of the problem or malfunction for the event a quick fix is available.

Sellers and Distributors can provide the necessary information to troubleshoot the most frequently encountered problems. Normally, Sellers and Distributors can offer a faster repair service than the Manufacturer would. Please note that Sellers can pinpoint problems due to wrong installation.

- 2 If your Seller cannot help you, contact **R.V.R. Elettronica**. and describe the problem; if our staff deems it appropriate, you will receive an authorisation to return the equipment along with suitable instructions;
- 3 When you have received the authorisation, you may return the unit. Pack the unit carefully before shipment; use the original packaging whenever possible and seal the package perfectly. The customer bears all risks of loss (i.e., R.V.R. shall not be liable for loss or damage) until the package reaches the R.V.R. factory. For this reason, we recommend insuring the goods for their full value. Returns must be sent on a C.I.F. basis (PREPAID) to the address stated on the authorisation as specified by the R.V.R. Service Manager.



Units returned without a return authorisation may be rejected and sent back to the sender.

- 4 Be sure to include a detailed report mentioning all problems you have found and copy of your original invoice (to show when the warranty period began) with the shipment.

Please send spare and warranty replacement parts orders to the address provided below. Make sure to specify equipment model and serial number, as well as part description and quantity.



R.V.R. Elettronica
Via del Fonditore, 2/2c
40138 BOLOGNA ITALY
Tel. +39 051 6010506

3. First Aid

All personnel engaged in equipment installation, operation and maintenance must be familiar with first aid procedures and routines.

3.1 Electric shock treatment

3.1.1 If the victim is unconscious

Follow the first aid procedures outlined below.

- Lay the victim down on his/her back on a firm surface.
- the neck and tilt the head backwards to free the airway system (**Figure 1**).

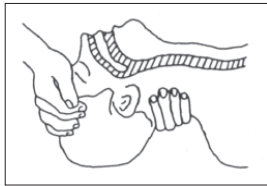

Figure 1

- If needed, open the victim's mouth and check for breathing.
- If there is no breathing, start artificial respiration without delay (**Figure 2**) as follows: tilt the head backwards, pinch the nostrils, seal your mouth around the victim's mouth and give four fast rescue breaths.



Figure 2

- Check for heartbeat (**Figure 3**); if there is no heartbeat, begin chest compressions immediately (**Figure 4**) placing your hands in the centre of the victim's chest (**Figure 5**).

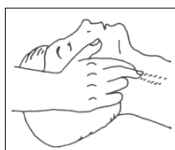

Figure 3

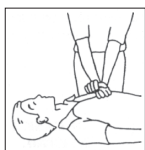

Figure 4

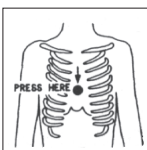

Figure 5

- One rescuer: give 2 quick rescue breaths after each 15 compressions.
- Two rescuers: one rescue breath after each 5 compressions.

- Do not stop chest compressions while giving artificial breathing.
- Call for medical help as soon as possible.

3.1.2 If the victim is conscious

- Cover victim with a blanket.
- Try to reassure the victim.
- Loosen the victim's clothing and have him/her lie down.
- Call for medical help as soon as possible.

3.2 Treatment of electric burns

3.2.1 Large burns and broken skin

- Cover affected area with a clean cloth or linen.
- Do not break any blisters that have formed; remove any clothing or fabric that is stuck to the skin; apply adequate ointment.
- Administer adequate treatment for the type of accident.
- Get the victim to a hospital as quickly as possible.
- Elevate arms and legs if injured.

If medical help is not available within an hour, the victim is conscious and is not retching, administer a solution of table salt and baking soda (one teaspoon of table salt to half teaspoon of baking soda every 250 ml of water).

Have the victim slowly drink half a glass of solution for four times during a period of 15 minutes.

Stop at the first sign of retching.

Do not administer alcoholic beverages.

3.2.2 Minor burns

- Apply cold (not ice cold) strips of gauze or dress wound with clean cloth.
- Do not break any blisters that have formed; remove any clothing or fabric that is stuck to the skin; apply adequate ointment.
- If needed, have the victim change into clean, dry clothing.
- Administer adequate treatment for the type of accident.
- Get the victim to a hospital as quickly as possible.
- Elevate arms and legs if injured.

4. General Description

The **TEX100LCD/S**, manufactured by **R.V.R. Elettronica**, is an exciter for Frequency Modulated **audio broadcasting** in a frequency modulation able to transmit in the band between 87.5 and 108 MHz, in step of 10 KHz, with an RF output power adjustable up to a maximum of 100 W into a 50 Ohm standard load.

The unit is factory aligned and calibrated at the time of manufacture. Because of this manufacture process, there is no field tune-up or alignment necessary.

Factory tolerances are:

- **Maximum Output Rated Power:** 50 dBm \pm 1 dB
- **Minimum Output Rated Power:** 40 dBm \pm 1 dB
- **Gain:** Not Applicable (the equipment is supplied without a radiant system, that shall be borne by the customer)

The **TEX100LCD/S** are designed to being contained into a 19" rack box of 2HE.

4.1 Unpacking

The package contains:

- 1 **TEX100LCD/S**
- 1 User Manual
- 1 Mains power cables

The following accessories are also available from Your R.V.R. Dealer:

- **Options for the equipment:**

	/AUDIGIN- TEX	/RDS- TEX2HE	/RDS- TEX-E- 2HE	/TLC- TEX2HE	/TLM- TEX2HE	/TLW- TEX2HE	/TLW- TEX-E- 2HE	/RTC- TEX	/FW2
/AUDIGIN-TEX		•	•	•	•	•	•	•	•
/RDS-TEX2HE	•		X	•	•	•	•	•	•
/RDS-TEX-E-2HE	•	X		•	•	•	•	•	•
/TLC-TEX2HE	•	•	•		X	X	X	•	•
/TLM-TEX2HE	•	•	•	X		X	X	•	•
/TLW-TEX2HE	•	•	•	X	X		X	•	•
/TLW-TEX-E-2HE	•	•	•	X	X	X		•	X
/RTC-TEX	•	•	•	•	•	•	•		•
/FW2	•	•	•	•	•	•	X	•	

•: compatible option / o: option already included / x: not compatible option

Table 4.1: table of compatibility of the various options

- **Spare parts**
- **Cables**

4.2 Features

This exciter contains a low-pass filter that reduces the harmonic emission to provided for by international standards (CCIR, FCC or ETSI) and can be connected directly to the antenna.

Two major features of **TEX100LCD/S** are compact design and user-friendliness. Design is based on a modular concept: the different functions are performed by modules that, for the most part, are connected through male and facilitates maintenance and module replacement.

The RF power section of the **TEX100LCD/S** features a MOSFET module delivering up to 100W output power.

Operating frequency stability is ensured by a temperature-compensated reference oscillator and is maintained by a PLL (Phase Locked Loop) system. The exciter will go into frequency lock within 30 seconds after power-on.



The **TEX100LCD/S** can operate throughout the frequency bank with no need for calibration or set-up.

An LCD on the front panel and a push-button board provide for user interfacing with the microprocessor control system, which offers the following features:

- Output power setup.
- Operating frequency setup.
- Power output enable/disable.
- Power Good feature (User-selectable output power alarm threshold).
- Measurement and display of transmitter operating parameters.
- Communication with external devices such as programming or telemetry systems via RS232 serial interface or I²C.

Four LEDs on the front panel provide the following status indications: **ON**, **LOCK**, **FOLDBACK** and **RF MUTE**.



The exciter has an input for the external 24 Vcc supply. This auxiliary supply source, that can be realized by the user with the help of rescue batteries, is automatically used in case of AC voltage absence.

The exciter management firmware is based on a menu system. User has four navigation buttons available to browse submenus: **ESC**, , , , and **ENTER**.

The rear panel features the mains input connectors, as well as audio input connectors and RF output connector, telemetry connector, protection fuses and two inputs for signals modulated onto subcarriers by suitable external coders, such as RDS (Radio Data System) signals commonly used in Europe.

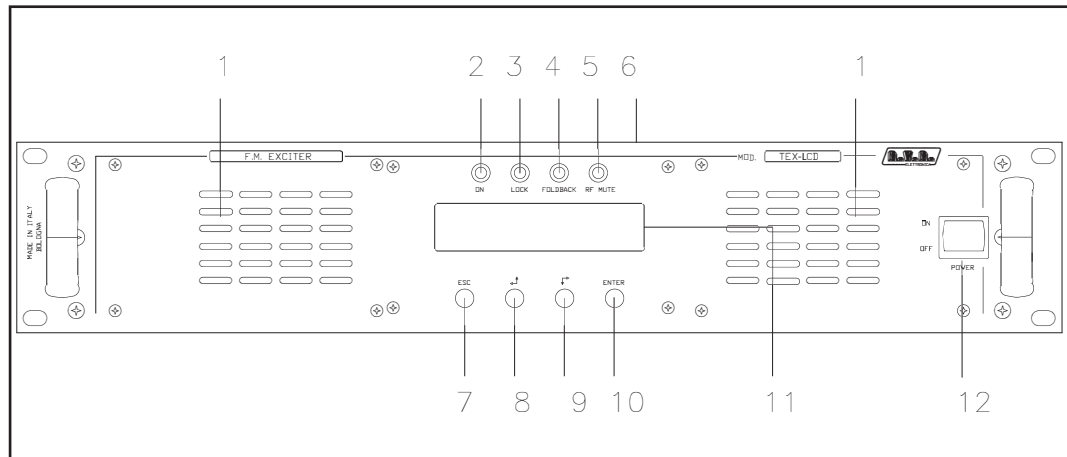
4.3 Frontal Panel Description



- | | |
|---|--|
| [1] AIR FLOW | Air flow for the forced ventilation. |
| [2] ON | Green LED, lit when the exciter is working. |
| [3] LOCK | Green led, lit when the PLL is locked on the working frequency. |
| [4] FOLDBACK | Yellow LED, lit when the foldback function is operating (automatic reduction of the delivered RF power). |
| [5] R.F. MUTE | Yellow LED, lit when the exciter's power output is inhibited by an external interlock command. |
| [6] CONTRAST | Display contrast adjusting trimmer (on the top of the equipment). |
| [7] ESC | Push button to exit from a menu. |
| [8]  | Push button to move in the menu system and to modify the parameters. |
| [9]  | Push button to move in the menu system and to modify the parameters. |
| [10] ENTER | Push button to confirm a parameter and to enter in a menu. |
| [11] DISPLAY | Liquid crystals display. |
| [12] POWER | ON/OFF switch. |

4.4 Rear Panel Description

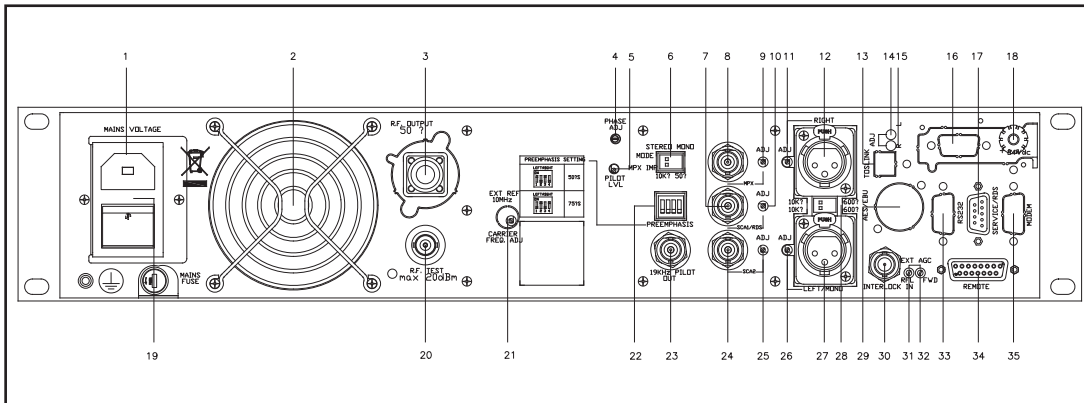

- | | |
|------------------------|---|
| [1] PLUG | VDE plug for mains supply. |
| [2] FAN | Fan for the forced ventilation of the exciter. |
| [3] R.F. OUTPUT | RF output connector, N-type, 50Ω. |
| [4] PHASE ADJ | Phase adjustment trimmer. |
| [5] PILOT LVL | Pilot tone adjustment trimmer. |
| [6] MODE/MPX IMP | Dip-switch to set the operation mode (STEREO or MONO) and the MPX input impedance, 50Ω or 10kΩ. |
| [7] SCA 1/RDS | BNC connector, SCA 1/RDS unbalanced input. |
| [8] MPX | BNC connector, MPX unbalanced input. |
| [9] MPX ADJ | Adjustment trimmer for MPX input. |
| [10] SCA 1/RDS ADJ | Adjustment trimmer for SCA 1/RDS input. |
| [11] RIGHT ADJ | Adjustment trimmer for the Right channel input. |
| [12] RIGHT | XLR connector, balanced Right channel input. |
| [13] TOSLINK | Not used. |
| [14] ADJ R | Not used. |
| [15] ADJ L | Not used. |
| [16] SLOT | Not used. |
| [17] SERVICE/RDS | DB9 connector for interconnection with other devices and for factory parameters programming. |
| [18] 24VDC IN | External 24Vdc supply input. Positive (red). |
| [19] FUSE BLOCK | Fuse carrier. Use a screwdriver to access the fuse. |
| [20] R.F. TEST POINT | RF test output, approx. 20 dBm wrt the RF output power level. |
| [21] CARRIER FREQ. ADJ | Fine adjustment trimmer for the carrier frequency. |
| [22] PREEMPHASIS | Dip-switch to set the preemphasis at 50 or 75 μs. The preemphasis setting is relevant only for the Left and Right inputs in stereo mode and for the mono input in mono mode, while MPX input is unaffected by this setting. |
| [23] 19KHZ PILOT OUT | BNC output for the 19 kHz pilot tone. This can be used for external devices (e.g. RDS coders) synchronization. |
| [24] SCA 2 | BNC connector, SCA2 unbalanced input. |
| [25] SCA2 ADJ | Adjustment trimmer for SCA2 input. |
| [26] LEFT/MONO ADJ | Adjustment trimmer for LEFT/MONO channel input. |
| [27] LEFT/MONO | XLR connector, balanced LEFT/MONO channel input. |
| [28] IMPEDANCE | Dip-switch to set the balanced input impedance, 600Ω or 10kΩ. |
| [29] AES/EBU | Not used. |
| [30] INTERLOCK IN | Interlock input BNC connector: the transmitter is forced in stand-by mode by grounding the central conductor. |

[31] RFL EXT. AGC	Trimmer for automatic gain control based on external signal of reflected power.
[32] FWD EXT. AGC	Trimmer for automatic gain control based on external signal of forward power.
[33] RS232	Not used.
[34] REMOTE	DB15 connector for telemetry of the machine.
[35] MODEM	Non used.

4.5 Connectors Description

4.5.1 Left (MONO) / Right

Type: Female XLR



1	GND
2	Positive
3	Negative

4.5.2 Remote

Type: Female DB15

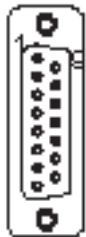

Pin	Name	Type	Meaning
1	Interlock	IN	By passes power if closed at GND
2	Ext AGC FWD	IN	Ext. signal, 1-12V, for power limitation (AGC)
3	GND		Ground
4	SDA IIC	I/O	IIC communication serial data
5	VPA TIm	ANL OUT	PA power supply voltage 3,9V F.S.
6	FWD TIm	ANL OUT	Forward power 3,9V F.S.
7	Power Good	DIG OUT	Open collector, enabled when power exceeds the set threshold
8	GND		Ground
9	GND		Ground
10	Ext AGC RFL	IN	Ext. signal., 1-12V, for power limitation (AGC)
11	SCL IIC	I/O	IIC communication clock
12	IPA TIm	ANL OUT	PA power supply current 3,9V F.S.
13	RFL TIm	ANL OUT	Reflected power 3,9V F.S.
14	On cmd	DIG IN	One grounded pulse (500 ms) enables power supply
15	OFF cmd	DIG IN	One grounded pulse (500 ms) disables power supply.

5. Installation and use

This section provides a step-by-step description of equipment installation and configuration procedure. Follow these procedures closely upon first power-on and each time any change is made to general configuration, such as when a new transmission station is added or the equipment is replaced.



IMPORTANT: *always remove the mains voltage before carrying out any type of installation and/or maintenance. It is essential to interrupt the power supply to avoid the risk of electric shock which could cause material damage to people or property, serious injuries and even death.*

The equipment must only be installed by qualified personnel.

With qualified personnel, it identifies personnel who respond to all directives, laws and regulations concerning safety, applicable to installation and operation of this device.

The choice of qualified, and appropriately trained, personnel is always under responsibility of the company in which this personnel is a part, because is the company in question that determines whether a worker is suitable for a particular job, in order to protect its safety by respecting the applicable law on workplace safety matter.

These companies must provide appropriate training to their staff on electrical devices, and make sure that they familiarize themselves with the contents of this manual.

The respect of the safety instructions set, forth in this manual or in the specified legislation, does not exempt you from compliance with other specific regulations regarding installation, place, Country or other circumstances affecting the equipment.



IMPORTANT: *there is a possible danger due electric shock, therefore it is mandatory to comply with the applicable law on safety with regard to electrical aspects.*

Once the desired configuration has been set up, no more settings are required for normal operation; at each power-up (even after an accidental shutdown), the equipment defaults to the parameters set during the initial configuration procedure.

The topics covered in this section are discussed at greater length in the next sections, with detailed descriptions of all hardware and firmware features and capabilities. Please see the relevant sections for additional detail.



IMPORTANT: *When configuring and testing the transmitter in which the equipment is integrated, be sure to have the Final Test Table supplied with the equipment ready at hand throughout the whole procedure; the Final Test Table lists all operating parameters as set and tested at the factory.*

5.1 Preparation

5.1.1 Preliminary Requirements

The equipment ventilation and the work space must be suitable for maintenance operations according to the directive in force in the country in which this device is installed.

It is necessary to leave a minimum distance of 50 cm on the front and back sides of the device to have a proper functioning and to facilitate air circulation through the ventilation grids.

In any case, the device must respect the distance established by the safety directive in force in the country where this equipment is installed.

This device is designed to operate at -10 °C to 45 °C without loss of performance. The ambient air must be clean of dust and not condensed; the maximum humidity must never exceed 95%.

It is important to remember that strong changes in temperature can lead to generation of condensation, in particular environmental conditions. In case of the station where this device is located should be subjected to these physical events, it is good to monitor these devices, once you put it into service, in addition to trying to protect the device itself as much as possible.



IMPORTANT: *never supply voltage to the equipment in presence of condensation. This problem can occur more frequently in devices warehoused for a long time or in those used as an active reserve.*

The antenna RF, power supply and connection cables must have the section suitable for the maximum current intensity.

5.1.2 Preliminary checks

Unpack the transmitter and immediately inspect it for transport damage. Check carefully that all the connectors are in perfect condition and check for the absence of humidity. Otherwise, wait until it is completely dry.

In case of problems in this step, immediately contact after-sales assistance.

The mains power supply protection fuses are conveniently located externally on rear panel. Remove the fuse holder with a screwdriver to check its integrity or to replace it if necessary. The following fuse are used:

	TEX100LCD/S @ 90÷260 Vac
Mains fuses	(1x) 6.3A tipo 5x20

Table 5.1: Fuses

5.1.3 Placement of equipment

Useful tips for a correct installation:

- Do not use in presence of external elements near inlets and outlets ventilation systems, as they could prevent a proper ventilation of the device.
- Do not place near any source of heat or flammable gas.
- Avoid places subject to accumulation of humidity, dust, sand, salt or environments that could compromise the correct operation of the equipment.
- Avoid installing the equipment into inhabited places due to possible noise pollution or on fragile supports. The operation of the equipment can cause a noise due to forced ventilation. The mounting surface must be able to withstand the weight of the device and must be sturdy.



Note: below we will refer to a complete station, where the device can be a part of it. The same procedures also apply in case of the device is used individually.

The device is usually connected inside a 19 “rack and fixed with M5 screws in the appropriate holes.

The equipment must be installed at least 1 mt from the ground.

Install the rack in the point in which the transmitter will be put in operation. The rack is mounted on wheels for easy movement so that, once placed in the desired location, it is advisable to use the four screws located at the base of the rack to stabilize it perpendicularly to ground.

The environment, where you have decided to install the rack, should be set up for about 25°C of air conditioning and equipped with a filter to remove dust and salt air.



The transmitter normally have the outlet air in the back of machine. In this case, provide adequate ventilation of the room.

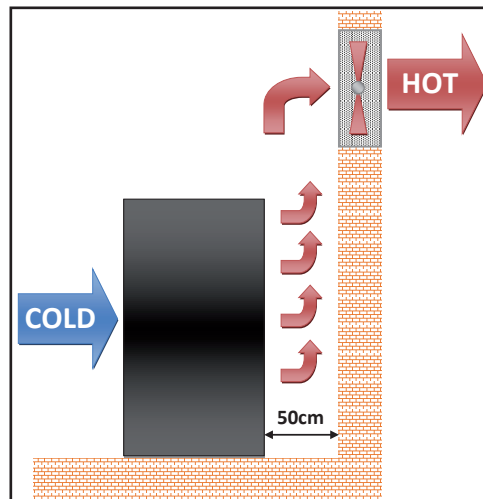

In alternative is cooled by forced ventilation and the air outlet is located on the roof of machine. Is recommended a length of tube approximetively of 1,5 meter.

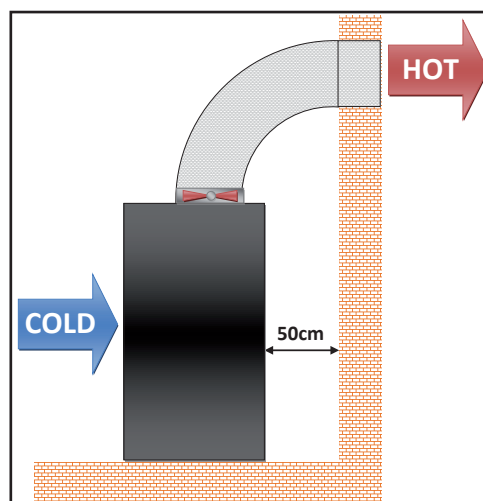

Is highly recommended to install the rack at least 50 cm from the rear and side wall so as to allow an optimum air flow and to facilitate workers.

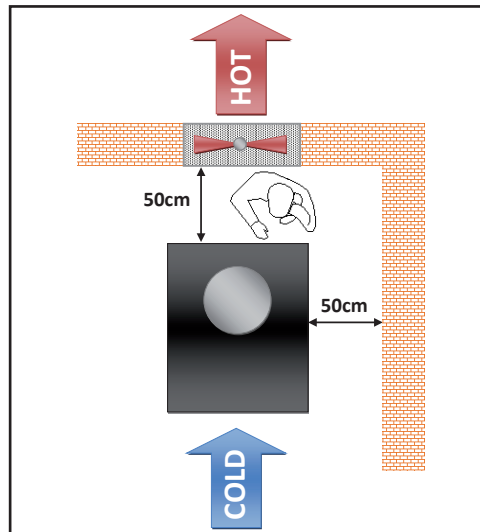

5.1.3.1 Rack power supply connections

Provide for the following (applicable to operating tests and putting into service):

- ✓ Single-phase 80 ÷ 260 VAC full-range for **TEX100LCD/S**, both with adequate earth connection.
- ✓ For operating tests only: dummy load with 50 Ohm impedance and adequate capacity (100W as a minimum for **TEX100LCD/S**).

Connect the overall power cord of machine. The cable can be slid through the cable gland located on the back, or on the roof, of the machine and conductors must be attached to the general disconnecting switch terminals.



Note: The connection of machine to power supply is done by fixing a multi-pole cable with exposed terminals to a terminal board. Make sure, with no possibility of error, that the cable is not under tension when you connect it to the machine.



WARNING: Is highly recommended to don't turn on the machine without first having connected the RF output to antenna or dummy load!

If you have a dummy load capable to dissipate the RF power generated by the transmitter, it is advisable to carry out first tests by linking to it rather than to the transmission antenna.

If transmitter require a single-phase power with F (black or brown or grey) + N (blue) + GND (green yellow), keep in mind this requirement to connect to your distribution board.

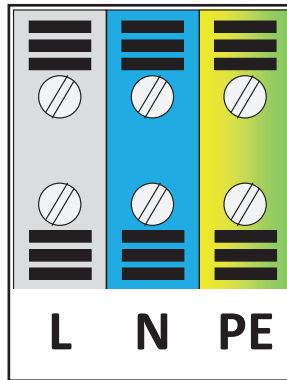

If transmitter require three-phase power with 3F (black, brown and grey) + N (blue) + GND (green yellow), keep in mind this requirement to connect to your distribution board.

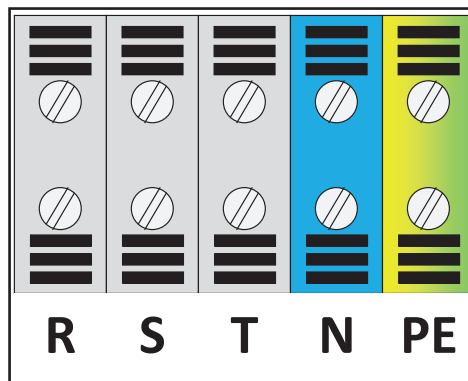

Note: the mains must be equipped with adequate earth connection properly connected to the equipment. This is a pre-requisite for ensuring operator safety and correct operation.

The following table shows the recommended cable cross-sections:

CONNECTOR	THREE-PHASE CABLE SECTION	SINGLE-PHASE CABLE SECTION
L	/	Ø 6mm
R	Ø 4mm	/
S	Ø 4mm	/
T	Ø 4mm	/
N	Ø 4mm	Ø 6mm
PE	Ø 4mm	Ø 6mm

Typically the distribution board contains the thermal-magnetic circuit breakers for each amplifier included in the system and one for service.

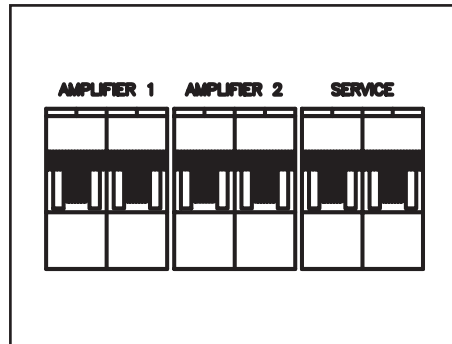

WARNING: Electric shock hazard! Never handle the RF output connector when the equipment is powered on and no load is connected. Injury or death may result.

Ensure that the distribution board of the transmitter is set to “OFF”.

5.1.4 Device power supply connections

Provide for the following (applicable to operating tests and putting into service):

- √ Single-phase 80 ÷ 260 VAC full-range for **TEX100LCD/S**, both with adequate earth connection.
- √ For operating tests only: dummy load with 50 Ohm impedance and adequate capacity (100W as a minimum for **TEX100LCD/S**).



Note: *to ensure the safety of the operators, carry out the wiring according to the laws and regulations in force in the country where this equipment is installed.*

Check that the **POWER** switch on the front of **TEX100LCD/S** is in the “**OFF**” position.

The transmitter has two switches: one is embedded in VDE socket for mains power cord and interrupts all mains power supply of the machine, while the second is on the front panel and acts by inhibiting the switching power supply of the machine.

Connect the mains power cable to the **MAINS** connector on the rear panel.



Warning: Be sure to connect the equipment correctly, to **avoid the risk of damaging**. It is necessary connect the ground conductor of the power supply cable to the specific terminal in the multipole socket and check the efficiency of your own grounding system.

The control and RF connection diagram, between the amplifier and its exciter, and the connection with the load are represented in figure 5.1.

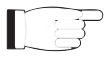

Note: to ensure both the safety of the operators and the correct functioning of the apparatus, it is essential that the network system is grounded, and that it is properly connected to the equipment.

Useful tips for a correct connection:

- Provide an adequate grounding of the electrical system. This has both a direct protection function, as it prevents receiving shocks by touching directly the metallic enclosures of the equipments, as well as an indirect protection function, as it interrupts the energy supply when a leak occurs due to poor insulation. This is possible on its own even through discharge devices, like the installation of a picket and an inspectable cockpit, through specific companies with qualified personnel to carry out the work.
- Provide an internal lightning protection such as a surge arrester (internal SPD) or a thermal-magnetic circuit breaker, requiring the installation in the distribution panel through qualified personnel. This solution allows you to protect from violent atmospheric electric shocks that strike the surrounding ground up to several kilometers.
- Provide an internal protection against interference on the distribution line such as EMI filters or stabilizers on line voltages, requiring the installation in the distribution panel through qualified personnel, which allow to filter the interferences caused by electrical equipment and sudden surges of the line, in addition to providing a voltage regulation.

5.1.5 RF Connections

Provide for the following setup (applicable to operating tests and putting into service):

√ Connection cable kit including:

- Mains power cable.
- Coaxial cable with BNC connectors for interlock signal connection between exciter and amplifier.
- RF cable for output to load / antenna (50 Ohm coaxial cable with standard N connector).
- Audio cables between transmitter and audio signals sources..



WARNING: risk of burns due to RF. Make sure that the device can not emit RF at the output, before connecting the antenna cable.



WARNING: For electromagnetic compatibility reasons, only double shielded cables must be used on the RF output.

Don't forget to equip yourself with a 7/8" 50 Ohm RF cable for the connection between the Antenna and the device; the part that goes towards the device must be equipped with a 7/8" type connector.

Connect the RF output of the transmitter to an antenna cable or to a dummy load

capable of dissipating the power generated by the amplifier. To begin with, set exciter to minimum output power and switch it off.

Connect the amplifier INTERLOCK OUT output to the matching INTERLOCK IN input fitted on all R.V.R. Elettronica exciters as standard; if your exciter is a different brand, identify an equivalent input.

Connect the RF output to an adequately rated dummy load or to the antenna.

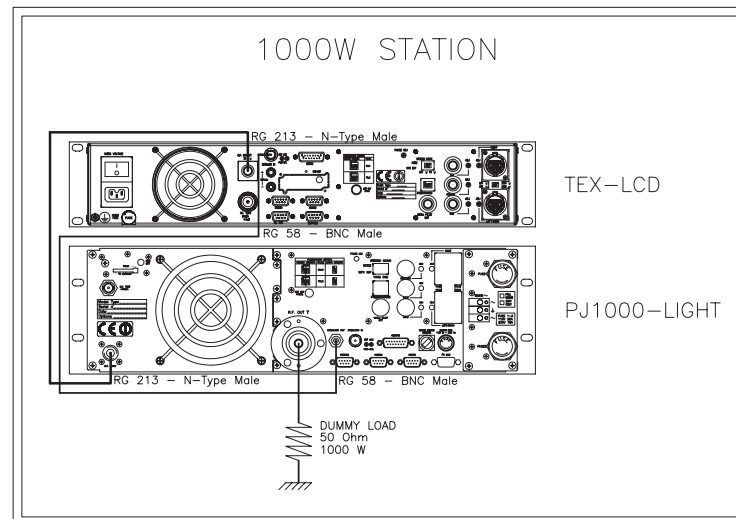

Figure 5.1: Connections with exciter



WARNING: To avoid electrical shock and electrocution, never touch the RF output connector when the equipment is switched on and no dummy load is connected.

Ensure that the POWER switch on the front panel of **TEX100LCD/S** is set to "OFF".

The exciter has two switches: one is embedded in VDE socket for mains power cord and interrupts all mains power supply of the machine, while the second is on the front panel and acts by inhibiting the switching power supply of the machine.

Connect the mains power cable to the MAINS connector on the rear panel.



Note: the mains must be equipped with adequate earth connection properly connected to the equipment. This is a pre-requisite for ensuring operator safety and correct operation.

Connect the audio and RDS/SCA signals from user's sources to the transmitter input connectors.



Note: RF EXPOSURE SAFETY DISTANCE (only for FCC & IC)
RF Exposure Limits for United States of America, according to FCC regulation: setting to the maximum of the output power of the apparatus, to guarantee the limits of exposure declared within this document, it is necessary that the antenna gain used with this device should be 0dBi or less and all

persons should maintain a minimum separation distance of **199.47 cm** for general uncontrolled exposure and general controlled exposure.

*RF Exposure Limits for Canada, according to IC regulation: setting to the maximum of the output power of the apparatus, to guarantee the limits of exposure declared within this document, it is necessary that the antenna gain used with this device should be 0dBi or less and all persons should maintain a minimum separation distance of **248.27 cm** for general uncontrolled exposure and general controlled exposure.*

*Limites d'exposition RF: en réglant au maximum de la puissance de sortie de l'appareil, afin de garantir les limites d'exposition déclarées dans ce document, il est nécessaire que le gain d'antenne utilisé avec cet appareil doit être de 0 dBi ou moins et toutes les personnes doivent conserver une distance de séparation minimale de **248.27 cm** pour les expositions générales non contrôlées et les expositions générales contrôlées.*

5.1.6 First power-on and setup

Perform this procedure upon first power-up and each time you make changes to the configuration of the transmitter this component is integrated into.



Note : Standard factory settings are RF output power off (**Pwr OFF**) and regulated output power set to upper limit (unless otherwise specified by customer).

5.1.6.1 Power-on

When you have performed all of the connections described in the previous paragraph, power on the exciter using the suitable power switch on the front panel.

5.1.6.2 Power check

Ensure that the **ON** LED turns on. Equipment name should appear briefly on the display, followed by forward power and modulation readings. If the RF output is disabled, those readings will be zero.

When the PLL locks to operating frequency, the LOCK LED will turn on.

5.1.6.3 How to enable the RF output

Check output power level and set it to maximum level (unless it has already been set) from the Power Setup menu that you will have accessed by pressing the following sequence of key: ESC (opens Default Menu) ⇒ ENTER (hold down for 2 seconds) ⇒ SET ⇒ use keys to set bar to upper limit.

Check the state of the **Pwr** output power by the **Fnc** menu. If it is set to **OFF**, press **ENTER** to bring the selection to **ON**.



5.1.6.4 Output power level control



Note: The exciter incorporates Automatic Gain Control (AGC) and output power is modulated based on the power level set by the user and actual operating conditions, such as temperature, reflected power and other parameters. Please read section 5.3 for more details of RF power modulation.

Access the **Power Setup Menu** pressing the following keys in the order:

ESC (opens **Default Menu**) ⇒ **ENTER** (hold down for 2 seconds).

Use the keys  and  in the **SET** menu to set exciter output power; the setting bar at the side of **SET** provides a graphic indication of power setting; please consider that the forward power readout provided on the display (**FWD: xxxx W**) reflects actual output power reading, **which may be lower than regulated power supply when Automatic Gain Control is running in power supply limitation mode** (please read section 5.3 about RF power supply modulation for more details).



Note: Output power may be set using the **Pwr OFF** control. In this condition, the output power readout (**Fwd**) on the display will read 0 (zero); the **SET** bar will reflect any adjustments you make using the keys and provides a graphic indication of how much power supply will be delivered the moment you return to **Pwr On** state.

5.1.6.5 Changing the *Power Good* alarm threshold

Change Forward Power Good alarm setting **PgD** from the **Fnc** menu as desired (factory setting is 50%).

5.1.6.6 Setting equipment I²C address

Change the **IIC** address in the **MIX** (Miscellaneous) menu as desired (factory setting is 01).

5.1.6.7 Adjustments and calibration

The only manual adjustments are the level adjustments and the audio mode adjustment.

The rear panel holds the trimmers for all exciter inputs. Trimmer identification is printed on the rear panel. Input sensitivity can be set within the limits set out in the tables below through the trimmers:

Input	Figure 6.2	Trimmer	Sensitivity	Notes
SCA1/ RDS	[13]	[16]	- 8 ÷ +13 dBu	Input level for 7,5 kHz overall deviation (- 20 dB)
SCA2	[28]	[29]	- 8 ÷ +13 dBu	
MPX	[14]	[15]	-13 ÷ +13 dBu	Input level for 75 kHz overall deviation (0 dB)
Left/ Mono	[31]	[30]	-13 ÷ +13 dBu	
Right	[18]	[17]	-13 ÷ +13 dBu	

When setting input sensitivity, please consider that the default menu reports instantaneous modulation level and an indicator provides a 75 kHz reading. To ensure correct adjustment, apply a signal with the same level as user's audio broadcast maximum level and then adjust using the trimmer until instantaneous deviation matches the 75 kHz reading.

To set subcarrier input levels, you may use the same procedure and option "x10" available in the **Fnc** menu. With this option, modulation level is multiplied by a factor of 10, which means that default menu bar meter reflects a 7.5 kHz deviation.

A special menu with separate indications of Left and Right channel levels and relating indicators of nominal levels for maximum deviation (75 kHz) is provided.

- Preemphasis:



- L and R (XLR type) input impedance:



Switch 1: R XLR input impedance, ON = 600 Ω, OFF = 10 kΩ

Switch 2: L XLR input impedance, ON = 600 Ω, OFF = 10 kΩ

- MPX input operation mode/impedance:



Switch 1: Mode of operation ON = Mono, OFF = Stereo

Switch 2: MPX input impedance, ON = 50 Ω, OFF = 10 kΩ

5.2 Operation

- 1) Power on the exciter and ensure that the **ON** light turns on. Equipment name should appear briefly on the display, quickly followed by modulation and forward power readings (Menu 1), provided that the exciter is delivering output power.



Menù 1

- 1b) In case of a password has been set, through the Miscellaneous menu, enter the code and then confirm to be able to view or modify the parameters of the machine.

The screen that is shown is similar to the following:

```

PUK: 012xyz
PSW: 0123
    
```

Menu 2



NOTE: It is advisable to write down the password set, if you forget the password it is not possible to recover it automatically. To recover the password, contact Customer Service by sending the alphanumeric PUK code of 6 characters generated automatically when entering the password.

1c) To **modify power level setting**, hold down the **ENTER** button until opening the **power setup menu**.

The edit screen will look like this:

```

SET: |||||
Fwd: 100 W
    
```

Menu 3

Next to **SET** indication, a bar provides a graphic display of preset output power. The filled portion of the bar is proportional to set power level.

<i>Example</i>		
100% output power	Full bar	≅ 100W output (mod. TEX100LCD/S)
25% output power	1/4 bar	≅ 25W output (mod. TEX100LCD/S)

The bottom line provides instantaneous power reading, press button to increase level, press to decrease it. When you have achieved the desired level, press **ENTER** to confirm and exit the **default menu**. Please note that the setting is stored automatically; in other words, if you press **ESC** or do not press any keys before the preset time times out, the latest power level set will be retained.



NOTA: This feature prevents the equipment from delivering maximum power as soon as output is enabled from menu 4, or in the event the equipment is already set to **ON** when you energise it.

2) Ensure that the equipment is not in a locked-out state. Press **ESC** to call up the selection screen (menu 3). Highlight **Fnc** and press **ENTER** to confirm and access the selected menu (menu 4).

If **PWR** is set to OFF, i.e. power output is disabled, move cursor to **PWR**. Press **ENTER** and label will switch to ON, i.e. power output is enabled.

Press **ESC** twice to go back to the default menu (menu 1).

- 3) Fine tune power setting from menu 2 (see description of item 1b) until achieving the desired value.



WARNING: Equipment is capable of delivering more than rated output power (100 W for **TEX100LCD/S**); however, never exceed the specified power rating.



NOTE: If power is set to 0 W in the **Power Setup Menu**, the INTERLOCK OUT contact is activated and any external appliances connected to it are immediately inhibited.

Next, you can review all operating parameters of the equipment through the management firmware.

Normally, the equipment can run unattended. Any alarm condition is handled automatically by the safety system or is signalled by the LED indicators on the panel or by display messages.



NOTE: Standard factory settings are output power set to upper limit (unless otherwise specified by customer) and **OFF**.

5.3 Management Firmware

The equipment features an LCD with two lines by 16 characters that displays a set of menus. The figure below provides an overview of equipment menus.

The symbols listed below appear in the left portion of the display as appropriate:

- _ (Cursor) - Highlights selected (i.e. accessible) menu.
- ▶ (Filled arrow) - Editable parameter marker. This symbol appears in menus that take up more than two lines to aid browsing.
- ▶▶▶ (Three empty arrows) - Parameter is being edited.
- ▶ (Empty arrow) - Current line marker; the parameter in this line cannot be edited. This symbol appears in menus that take up more than two lines to aid browsing.

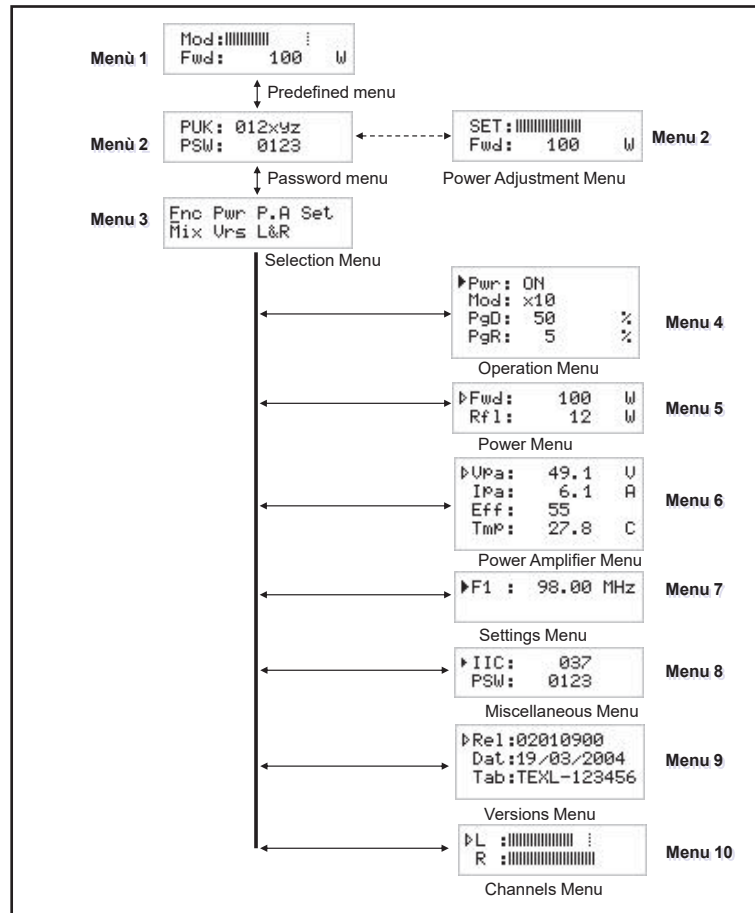

Figure 5.2

When the display is off, touching any key will turn on backlighting.

When the display is on, pressing the **ESC** button from the **default menu** (menu 1) calls up the **selection screen** (menu 3), which gives access to all other menus:

```

Enc Pwr P.A Set
Mix Urs L&R
    
```

Menu 3

If the temperature alarm is enabled and the alarm threshold is exceeded, the following screen will be displayed (only if you are in the default screen):

```

!! ATTENTION !!
OVER TEMPERATURE
    
```

State 1

As soon as operating conditions are restored, power output is re-enabled with the same settings in use prior to the alarm condition.

Under 20kHz, no modulation occurs. After a preset time of about 5 minutes (not editable), a NO AUDIO condition is indicated in the main screen, but power is not inhibited.

```

Mod: NO AUDIO
Fwd: 0 W
    
```



State 2

To gain access to a submenu, select menu name (name is highlighted by cursor) using button or and press the **ENTER** button.

To return to the **default menu** (menu 1), simply press **ESC** again.

5.3.1 Operation Menu (Fnc)

In this menu, you can toggle exciter **power output** On/Off, set **deviation display mode** and the threshold rate for **Forward (PgD)** or **Reflected (PgR) Power Good**.

To edit an item, highlight the appropriate line using the  and  buttons and then press and hold the **ENTER** button until the command is accepted. This way, Pwr setting is toggled between On and Off and Mod setting is toggled between “x1” and “x10”. To edit the Power Good rate, simply select item “PgD” or “PgR” and edit its value using the UP and DOWN buttons; finally, press ENTER to confirm.

```

▶ Pwr: ON
  Mod: x10
  PgD: 50 %
  PgR: 5 %
    
```

Menu 5

Pwr Enables (ON) or disables (OFF) exciter power output.

- Mod Modifies modulation display (toggles between “x1” and “x10”). In “x10” mode, instantaneous deviation indication is multiplied by a factor of 10, and the bar meter on the default menu will reflect 7.5 kHz instead of 75 kHz. This display mode is convenient when you wish to display low deviation levels, such as those caused by pilot tone or subcarriers.

- PgD Modifies Power Good threshold for forward power. The Power Good rate is a percent of equipment rated power (100 W for **TEX100LCD/S**), not of forward output power. This means that this threshold set at 50% will give 50 W regardless of set power level. The Power Good feature enables output power control and reporting. When output power drops below set Power Good threshold, the equipment changes the state of pin [7] of the DB15 “Remote” connector located on the rear panel.

- PgR Modifies Power Good threshold for reflected power. The Power Good rate is a percent of equipment rated power (10 W for **TEX100LCD/S**), not of reflected output power. This means that this threshold set at 5% will give 0,50 W regardless of set power level. The Power Good feature enables output power control and alarm management.



NOTE: This alarm does not trip any contacts in the DB15 “Remote” connector and is only available in systems equipped with telemetry.

5.3.2 Power menu(Pwr)

This screen holds all readings related to equipment output power:

```



▶Fwd:      100    W
Rfl:       12     W
```

Menu 6

- Fwd Forward power reading.
- Rfl Reflected power reading.

Note that these are readings, rather than settings, and cannot be edited (note the empty triangle). To change power setting, go to the **default menu** as outlined earlier.

5.3.3 Power Amplifier (P.A) Menu

This screen is made up of four lines that can be scrolled using the  and  buttons and shows the readings relating to final power stage:

Vpa:	50.2	V
Ipa:	32.9	A
Eff:	57	%
Tmp:	27.8	°C

Menu 7

Note that these are readings, rather than settings, and cannot be edited (note the empty arrow).

- VPA Voltage supplied by amplifier module.
- IPA Current draw of amplifier module.
- Eff Efficiency based on ratio of forward power to amplifier module power, in percent (FWD PWR/(Vpa x Ipa) %).
- Tmp Equipment internal temperature reading.

5.3.4 Setup Menu (Set)

This menu lets you view and set operating frequency.

F1 :	98.00	MHz
------	-------	-----

Menu 8

- F1 Operating frequency setup. Set a new frequency value and then press the **ENTER** button to confirm your selection; the exciter unlocks from current frequency (the **LOCK** LED turns off) and will lock to the new operating frequency (**LOCK** turns back on again).
If you press **ESC** or let the preset time time out, the previous frequency setting is retained.

5.3.5 Miscellaneous Menu (Mix)

This menu lets you set equipment address in an I²C bus serial connection:

```

▶ IIC:    037
PSW:    0123
    
```

Menu 9

- IIC I²C address setting. The I2C network address becomes significant when the exciter is connected in an RVR transmission system that uses this protocol. Do not change it unless strictly required.
- PSW Setting a numeric password of 4 characters.
At the time of purchase, the password is set to [0000] by default; this configuration automatically disables the entry of the password in default screen.



NOTE: It is advisable to write down the password set, if you forget the password it is not possible to recover it automatically. To recover the password, contact Customer Service by sending the alphanumeric PUK code of 6 characters generated automatically when entering the password.

5.3.6 Version Menu (Vrs)

This screen holds equipment version/release information::

```

▶ Rel:02010900
Dat:19/03/2004
Tab:TEXL-123456
    
```

Menu 10

Note that these are readings, rather than settings, and cannot be edited (note the empty arrow).

- Rel Firmware release information.
- Dat Release date.
- Tab Shows table loaded in the memory.

5.3.7 Channels Menu (L&R)

Right and left channel input levels are displayed as horizontal bars as shown in the figure below.

The bar meter reflects the level corresponding to a 100% deviation for each channel and provides a convenient reference when setting audio channel input levels.



Menu 11

- L Left channel Vmeter.
- R Right channel Vmeter..

5.4 Optional Function

A range of options is available for the product to add certain functions and/or modify existing functions. Outlined below are the functions available at the moment, which must be specified on order to R.V.R. Elettronica.

5.4.1 FSK Option

The FSK function generates periodic carrier frequency shifts to generate a Morsecode station ID code.



NOTE: This function is typically used in the USA.

The factory setting for frequency shift is +10KHz and code repetition period is 60 minutes (please contact R.V.R. Elettronica if you need different settings), whereas station identified may be programmed by the user following the indications provided in section below.

When the FSK option is fitted, an FSK submenu is added to the **selection menu**.

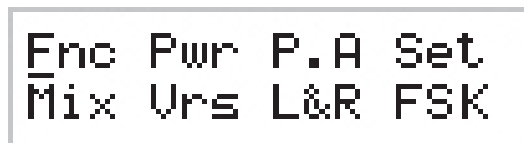

Menu 12

Press the **ENTER** key when FSK is highlighted in the **selection menu** to access the FSK submenu:

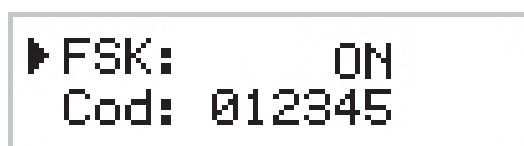

Menu 13

FSK	Enables / disables FSK code transmission.
Cod	Shows the Morse code sent normally.

5.4.1.1 Changing the ID code

User may change the FSK code used as a station identifier at any time.

This procedure requires:

- 1 RS232 male-female cable;
- Hyper Terminal interface (make sure it has been installed together with Windows®) or equivalent serial communication software.

A brief description of the procedure is provided below:

- Connect the PC serial port COM to the SERVICE connector on the rear panel of **TEX100LCD/S** using a standard Male DB9 - Female DB9 serial cable.
- Power on the exciter;
- Launch the serial communication software;
- Set communication parameters as follows:
 - Baud Rate:** 19200
 - Data Bit:** 8
 - Parity:** None
 - Stop Bit:** 1
 - Flow control:** None;
- Activate Caps-Lock through the communication software and send string CODE followed by the 6-character station ID code followed by Enter.



NOTE: To be treated as valid, the code must be made up of 6 alphanumeric characters and must contain no blank spaces; if acknowledged as valid, code is echoed back to the terminal, illegal codes are not echoed.

6. Identification and Access to the Modules

6.1 Identification of the Modules

The **TEX100LCD/S** is made up of various modules linked to each other through connectors so as to make maintenance and any required module replacement easier.

6.1.1 TEX100LCD/S Upper view

The figure below shows the equipment upper view with the various components pointed out.

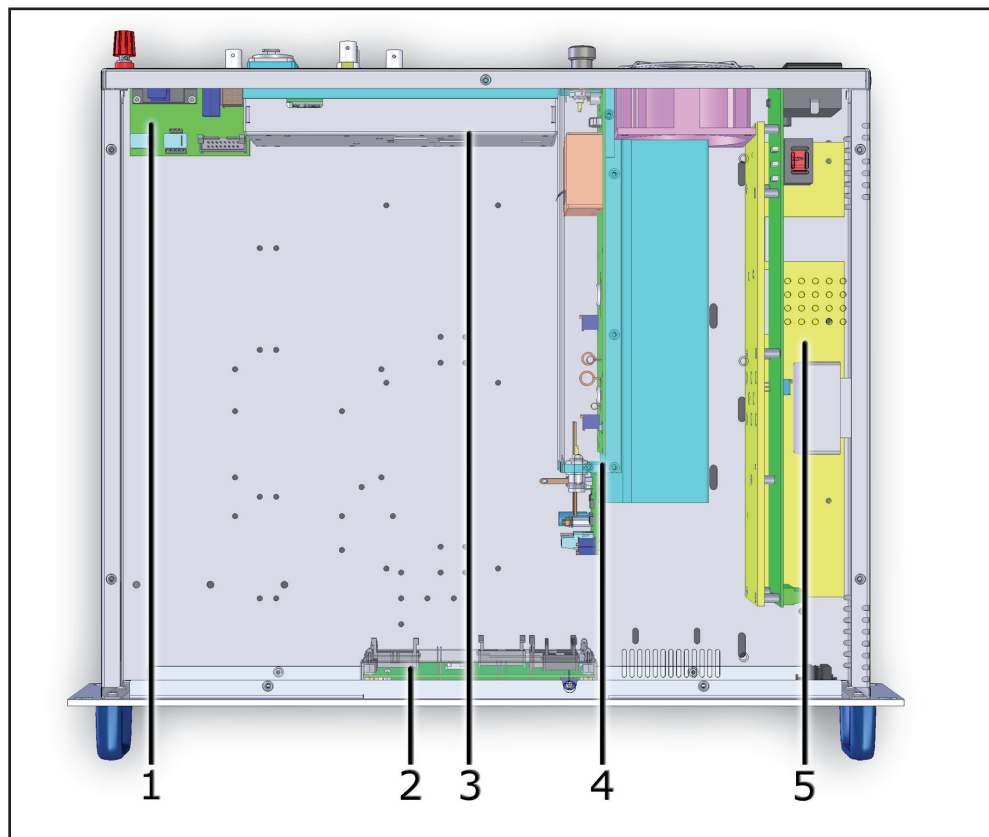

figure 8.1

- [1] Main Board & Stereo Coder Card
- [2] Panel Card
- [3] Telemetry Card
- [4] Control Card & Power Amplifier
- [5] Power Supply

7. Working Principles

7.1 Panel board

The panel board contains the microcontroller (PIC18F452) that implements the equipment control software, the display and the other components needed to interface with the user.

The board is connected with the other machine modules, both for power supply distribution and for the control and measures.

7.2 Main board

The main board carries out the following functions:

- Audio and SCA input treatment
- Generation of carrier frequency
- Modulation
- R.F. amplification (Driver)

The board also features a stereophonic coder.

7.2.1 Audio input section

The audio input section contains the circuits that perform the following functions:

- Input impedance selection
- 15 kHz filtering of the left and right channel
- Stereophonic Coding
- Mono channel preemphasis
- Mono, MPX and SCA channel mixing
- Clipper (limits the modulating signal level so that the frequency deviation does not exceed 75 kHz)
- Modulating signal measurement

7.2.2 PLL/VCO section

This board section generates the modulated radiofrequency signal. It is based on a PLL scheme that uses an integrated MB15E06 type.

7.2.3 Driver section

Before passing to the final power amplifier, the RF signal is preamplified in this section by an ERA3 transistor. When the exciter is placed on stand-by, the driver is by-passed.

7.3 Telemetry board

This board is designed to inform the user of the equipment operation state. All input and output signals are available on the DB15 connector.

The same board also features the “INTERLOCK” BNC connector for disabling the device. By grounding the central pin, the output power is reduced to zero until the connection is removed.

When an R.V.R. amplifier is used, this connector is linked to the power amplifier REMOTE or INTERLOCK by means of a BNC-BNC connection. In case of amplifier faults, the central conductor is grounded thus forcing the machine to enter in stand-by mode.

7.4 Power Supply

The **TEX100LCD/S** power supply unit is a switching-type unit whose +28 V main output powers the machine's RF amplifier. The power supply also features stabilizers for generating continuous +5 V, -15V, +8V, +18 V and -18 V voltages for powering the other device circuits. The power supply unit is also connected to 24 V auxiliary continuous voltage inputs used to automatically buffer the mains power cutoff.

7.5 Power Amplifier

The final power stage is enclosed in a totally shielded metal container fastened in the centre of the device.

The RF signal coming from the “main” card reaches the pilot, is amplified and is then sent to the final stage that sees to its final amplifications up to 100W.

The amplifier is made in two stages. The first is made with BLF244 and the last with BLF147.

In addition to the actual RF amplification, this circuit carries out the following functions:

- Measures of the forward and reflected power by means of directional couplers
- Low-pass filtering of the RF signal in output

On this card is an RF sample approximately -30dB compared with the output that is available on a BNC connector underneath the output connector of the transmitter. This sample is useful for checking the characteristics of the carrier, but not of the higher order harmonics.

7.6 Control Board

The main function of this board is to check and correct the MOSFET polarization voltage of the RF amplifier section.

It also provides the measurement of the absorbed current and contains a circuit for signaling power supply unit faults.

If no alarms are present, the voltage is adjusted only depending on the set output power, with a feedback mechanism based on the reading of the power really delivered (AGC).

The voltage is also affected by other factors, such as:

- Control of the power level in output, depending on the setting
- External AGC signals (Ext. AGC FWD, Ext. AGC RFL).
- Excess of temperature.
- Excess of absorbed current from the RF module.

8. Maintenance and repair procedures

8.1 Introduction

This section provides general information about maintenance and electrical settings for the **TEX100LCD/S** exciter.

The maintenance is separated into two sections depending on the complexity of the procedure and the instrumentation required for the test to complete the maintenance.

8.2 Security Considerations

Dangerous voltages and high currents are present inside the amplifier, when it is working; strong power RF signals are present, also.



WARNING: Do not remove any covers without first turning the equipment off and making sure that you have closed them all before restarting the equipment. Be sure to disconnect the amplifier's mains supply before proceeding to any maintenance operation on the system..

8.3 Ordinary maintenance

The only regular maintenance required on the **TEX100LCD/S** is the periodic blower replacement and dust cleaning of the air filter and of any trace of it inside the amplifier.

The frequency of these operations depends on the operating conditions of the machine: like ambient temperature, dust level in the air, humidity, etc ...

It is advisable to make a preventive inspection every 6 months, and to replace the blowers that has abnormal noises.

The blowers should be replaced, in case of problems, as soon as possible and in any case not later than 24 months.

9. Option

This section displays views on the variants compared to the basic version to be requested in the order.



NOTE: For more information about the options, rely on the respective user manuals.



IMPORTANT: All options must be requested at the time of order to be installed and tested together with the apparatus.

9.1 /AUDIGIN-TEX option

Digital Audio Input with AES/EBU and TOSLINK automatic selection.

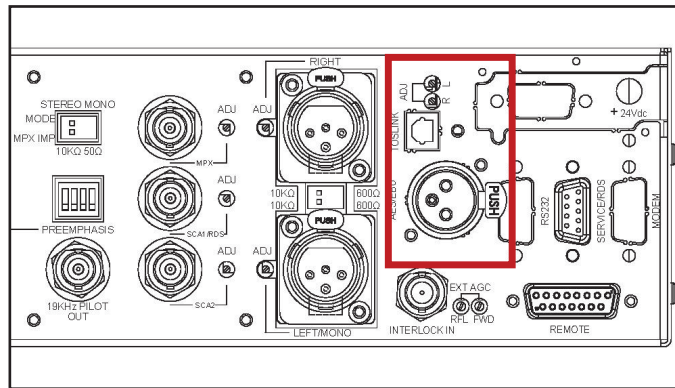

Digital Input



Type: TOSLINK Female

Left (MONO) / Right

Type: XLR Female



- 1 GND
- 2 Positive
- 3 Negative

9.2 /RDS-TEX2HE & /RDS-TEX-E-2HE option

Integrated RDS encoder.

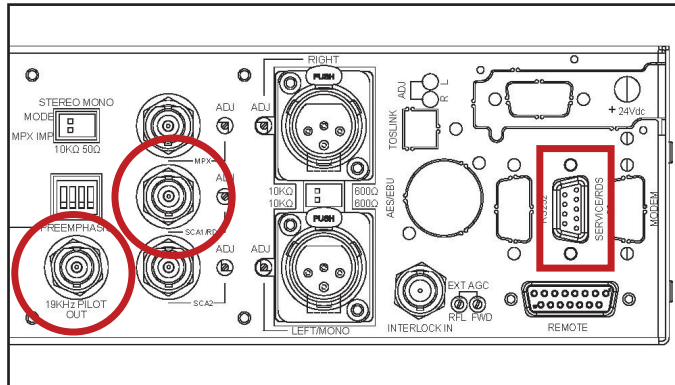

Service/RDS

Type: DB9 Female



- | | |
|---|-----------------|
| 1 | GND |
| 2 | RS232 TX |
| 3 | RS232 RX |
| 4 | NC |
| 5 | GND |
| 6 | NC |
| 7 | NC |
| 8 | RDS CARRIER OUT |
| 9 | PILOT IN |

9.3 /TLC-TEX2HE option

Integrated serial telemetry with the possibility of an external modem.

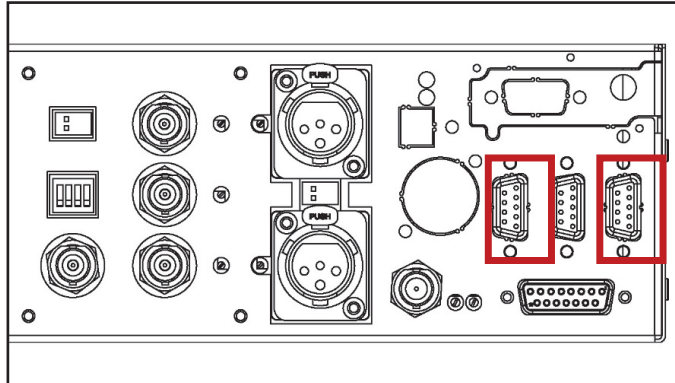

RS232 Bus

Type: DB9 Female

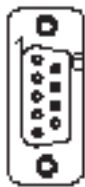

- 1 NC
- 2 TX_D
- 3 RX_D
- 4 Internally connected with 6
- 5 GND
- 6 Internally connected with 4
- 7 Internally connected with 8
- 8 Internally connected with 7
- 9 NC

Modem

Type: DB9 Female

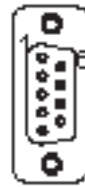

- 1 NC
- 2 NC
- 3 NC
- 4 NC
- 5 GND
- 6 +12 V
- 7 NC
- 8 NC
- 9 NC

9.4 /TLM-TEX-E-2HE option

Telemetry with integrated modem.

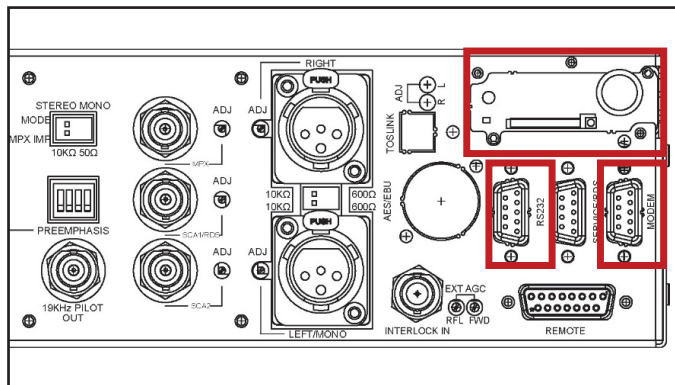

RS232 Bus

Type: DB9 Female



- 1 NC
- 2 TX_D
- 3 RX_D
- 4 Internally connected with 6
- 5 GND
- 6 Internally connected with 4
- 7 Internally connected with 8
- 8 Internally connected with 7
- 9 NC

Modem

Type: DB9 Female



- 1 NC
- 2 TX_D
- 3 RX_D
- 4 NC
- 5 GND
- 6 +12 V
- 7 NC
- 8 NC
- 9 NC

9.5 Opzione /TLW-TEX-E-2HE option

Telemetry with integrated LAN.

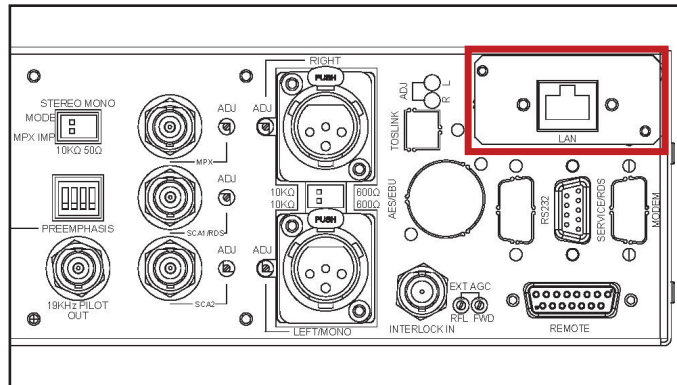

Ethernet

Type: RJ45 Female

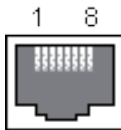

- 1 TX+
- 2 TX-
- 3 RX+
- 4 NC
- 5 NC
- 6 RX-
- 7 NC
- 8 NC

9.6 /TLW-TEX2HE option

Telemetry with integrated LAN with the possibility of an external modem.

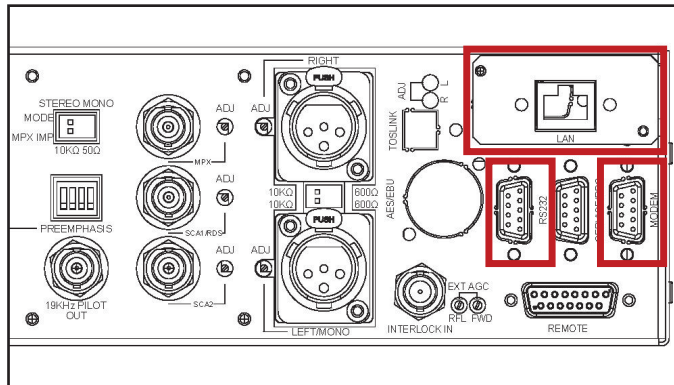

RS232 Bus

Type: DB9 Female



- 1 NC
- 2 TX_D
- 3 RX_D
- 4 Internally connected with 6
- 5 GND
- 6 Internally connected with 4
- 7 Internally connected with 8
- 8 Internally connected with 7
- 9 NC

Modem

Type: DB9 Female



- 1 NC
- 2 NC
- 3 NC
- 4 NC
- 5 GND
- 6 +12 V
- 7 NC
- 8 NC
- 9 NC

Ethernet

Type: RJ45 Female

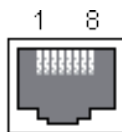

- 1 TX+
- 2 TX-
- 3 RX+
- 4 NC
- 5 NC
- 6 RX-
- 7 NC
- 8 NC

9.7 /RTC-TEX option

The /RTC-TEX hardware option replaces the electronic panel with a version that includes an integrated clock and allows you to enable two daily power changes at pre-established and programmable times with weekly programming.

9.8 /FW2 option (only software)

The /FW2 software option modifies the protocol on the RS232 connector, to allow the use of an ASCII type man-machine interface.

This modification excludes the connection with the TELECON 32bit and at the same time the management of the modem.

9.9 UP/DOWN Power option (only software)

The UP/DOWN Power software option modifies on and off control signals of the RF section into emitted RF power level control signals, allowing an UP/DOWN type regulation.

The UP or DOWN command is provided by switching the corresponding signal on the connector to ground for at least 500mS (pin features internal pull-up to power supply).



NOTE: This option does not have any manual because the following description is enough.

Configuration of DB15F telemetry connector (Remote):



Pin	Standard Function	UP/DOWN Power Function
14	On cmd <i>Enables the RF power supply</i>	Up cmd <i>Increases the RF power supply</i>
15	Off cmd <i>Disables the RF power supply</i>	Down cmd <i>Reduces the RF power supply</i>



R.V.R. Elettronica

Via del Fonditore, 2 / 2c
Zona Industriale Roveri · 40138 Bologna · Italy
Phone: +39 051 6010506 · Fax: +39 051 6011104
e-mail: info@rvr.it · web: <http://www.rvr.it>

Member of CISQ Federation



CERTIFIED MANAGEMENT SYSTEM
ISO 9001

The RVR Logo, and others referenced RVR products and services are trademarks of RVR Elettronica in Italy, other countries or both. RVR © 1998 all rights reserved.
All other trademarks, trade names or logos used are property of their respective owners.