



TEX1002TFT

USER MANUAL
VOLUME1



File Name: TEX1002TFT_ITA_1.1.indb

Version: 1.1

Date: 29/06/2020

Version History

Date	Version	Reason	Editor
29/11/2019	1.0	First edition	J. H. Berti
29/06/2020	1.1	Maintenance and Repair Update	J. H. Berti

TEX1002TFT - User Manual
Version 1.1

© Copyright 2019 - 2020
R.V.R. Elettronica S.r.l.
Via del Fonditore 2/2c
40138 - Bologna - Italy
Phone: +39 051 6010506
Fax: +39 051 6011104
Email: info@rvr.it
Web: www.rvr.it

All rights reserved.

Printed in Italy. No part of this manual may be reproduced, memorized or transmitted in any form or by any means, electronic or mechanic, including photocopying, recording or by any information storage and retrieval system, without written permission of the copyright owner.

Notification of intended purpose and limitations of product use

This product is a FM transmitter intended for FM audio broadcasting. It utilizes operating frequencies not harmonised in the intended countries of use. The user must obtain a license before using the product in intended country of use. Ensure respective country licensing requirements are complied with. Limitations of use can apply in respect of operating frequency, transmitter power and/or channel spacing.

Declaration of Conformity

Hereby, R.V.R. Elettronica, declares that this FM transmitter is in compliance with the essential requirements and other relevant provisions of Directive 2014/53/EU.



Technical Specifications

		TEX1002TFT		
Parameters		U.M.	Value	Notes
GENERALS				
Frequency range		MHz	87.5 - 108	
Rated output power		W	1000	Continuously variable by software from 0 to maximum
Modulation type			F300E	
Operational Mode			Mono, Stereo, MPX	
Working temperature		°C	-5 to 60	
Working Humidity		%	95 (Without condensing)	
Working Altitude		mt	3000	With adequate air evacuation system in site
Frequency programmability		kHz	10	
Frequency stability	Working Temp. from -5°C to 50°C	ppm	±1	
Modulation capability	Referred @ 0dBu for 75kHz	kHz	150	Meets or exceeds all FCC and CCIR rules
Pre-emphasis mode		µS	0, 50, 75	selectable by rear panel dip switches
Spurious & harmonic suppression		dBc	>75 (80 typical)	Meets or exceeds all FCC and CCIR rules
Asynchronous AM S/N ratio	Referred to 100% AM, with no de-emphasis	dB	≥ 55 (typical 60)	
Synchronous AM S/N ratio	Referred to 100% AM, FM deviation 75 kHz by 400Hz sine, without de-emphasis	dB	≥ 50 (typical 55)	
MONO OPERATION				
S/N FM Ratio	RMS @ ± 75 kHz peak, HPF 20Hz - LPF 23 kHz, 50 µS de-emphasis	dB	> 80 (typical 82)	
	Qpk @ ± 75 kHz peak, CCIR weighted, 50 µS de-emphasis	dB	> 72	
	Qpk @ ± 40 kHz peak, CCIR weighted, 50 µS de-emphasis	dB	> 66	
Frequency Response	30Hz ± 15kHz	dB	± 0,05	
Total Harmonic Distortion	THD+N 30Hz ± 15kHz	%	0.1 (typical 0.07)	
Intermodulation distortion	Measured with a 1 KHz, 1.3 KHz tones, 1:1ratio, @ 75 kHz FM	%	< 0,2	
Transient intermodulation distortion	3.18 kHz square wave, 15 kHz sine wave @75 kHz FM	%	< 0,1	
MPX OPERATION				
Composite S/N FM Ratio	RMS @ ± 75 kHz peak, HPF 20Hz - no LPF, 50 µS de-emphasis	dB	> 80dB typ. 82dB	
Frequency Response	30Hz ± 53kHz	dB	± 0,2	
	53kHz ± 100kHz	dB	± 0,5	
Total Harmonic Distortion	THD+N 30Hz ± 53kHz	%	0,1	
	THD+N 53kHz ± 100kHz	%	0,2	
Intermodulation distortion	Measured with a 1 KHz, 1.3 KHz tones, 1:1ratio, @ 75 kHz FM	%	< 0,05	
Transient intermodulation distortion	3.18 kHz square wave, 15 kHz sine wave @75 kHz FM	%	< 0,1	
Stereo separation	30Hz ± 15kHz	dB	> 50	
STEREO OPERATION				
Stereo S/N FM Ratio	RMS @ ± 75 kHz peak, HPF 20Hz - LPF 23 kHz, 50 µS de-emphasis, L & R demodulated	dB	> 75 (typical 78)	
	Qpk @ ± 75 kHz peak, CCIR weighted, 50 µS de-emphasis, L & R demodulated	dB	> 67	
	Qpk @ ± 40 kHz peak, CCIR weighted, 50 µS de-emphasis, L & R demodulated	dB	> 61	
Frequency Response	30Hz ± 15kHz	dB	± 0,5	
Total Harmonic Distortion	THD+N 30Hz ± 15kHz	%	0.1 (typical 0.07)	
Intermodulation distortion	Measured with a 1 KHz, 1.3 KHz tones, 1:1ratio, @ 75 kHz FM	%	< 0,02	
Transient intermodulation distortion	3.18 kHz square wave, 15 kHz sine wave @75 kHz FM	%	< 0,1	
Stereo separation	30Hz ± 15kHz	dB	> 50	
Main / Sub Ratio	30Hz ± 15kHz	dB	> 40	
SCA OPERATION				
Frequency response	40kHz ± 100kHz	dB	± 0,5	
Crosstalk to main or to stereo channel	RMS, ref @ ± 75 kHz peak, no HPF/LPF, 0µS de-emphasis, with 67 kHz tone on SCA input @ 7.5kHz FM deviation	dB	> 75	
	RMS, ref @ ± 75 kHz peak, no HPF/LPF, 0µS de-emphasis, with 92 kHz tone on SCA input @ 7.5kHz FM deviation	dB	> 78	
POWER REQUIREMENTS				
AC Power Input	AC Supply Voltage	VAC	230 ±15%	(*) Internal switch (**) monophase (***) Threephases Y
	AC Apparent Power Consumption	VA	1450	
	Active Power Consumption	W	1447	
	Power Factor		0,998	
	Overall Efficiency	%	> 70	
	Connector		VDE 16A	
DC Power Input	DC Supply Voltage	VDC	//	
	DC Current	ADC	//	(**)max 25W (***) max 140W
MECHANICAL DIMENSIONS				
Physical Dimensions	Front panel width	mm	483 (19")	19" EIA rack
	Front panel height	mm	88 (3 1/2") 2HE	convertire in pollici
	Overall depth	mm	561	
	Chassis depth	mm	470	escluso il pannello, esclusi i connettori, convertire in pollici
Weight		kg	approx. 11	
VARIOUS				
Cooling			Forced, with internal fan	
Acoustic Noise		dBA	< 75	

AUDIO INPUTS				
Left / Mono	Connector		XLR F	
	Type		Balanced	
	Impedance	Ohm	10 k or 600	Selectable by rear panel dip switches
Right	Input Level / Adjust	dBu	-12 to +12	continuously variable
	Connector		XLR F	
	Type		Balanced	
MPX	Impedance	Ohm	10 k or 600	Selectable by rear panel dip switches
	Input Level / Adjust	dBu	-12 to +12	for 75 KHz FM, externally adjustable
	Connector		BNC	
SCA/RDS	Type		unbalanced	
	Impedance	Ohm	10 k	
	Subcarrier Level @ 0 dBu	dB	-17 to -40	referred 75 KHz FM
AES/EBU (optional)	Connector		XLR F	
	Type		Balanced	
	Impedance	Ohm	110	
TOS/Link (optional)	Input Level / Adjust	dBfs	0 to -10	Relative to Analog Level, externally adjustable
	Connector		TOS-LINK	
	Type		Optical	
OUTPUTS				
RF Output	Connector		7/8"	
	Impedance	Ohm	50	
RF Monitor	Connector		BNC	
	Impedance	Ohm	50	
	Output Level	dBm	0 ± 4	Referred to the Maximum RF output
Pilot output	Connector		BNC	For RDS synchronizing purpose
	Load Impedance	Ohm	>5 k	
	Output Level	Vpp	1	
AUXILIARY CONNECTIONS				
Interlock	Connector		BNC	Input and output for remote power inhibition (short is RF off)
Remote Interface	Connector		DB15F	
RDS (optional)	Connector		DB9 F	
RS232 (optional)	Connector		DB9 F	
MODEM (optional)	Connector		DB9 F	
Service (optional)	Connector		DB9 F	Factory reserved for firmware program
LAN (optional)	Connector		RJ45	
FUSES				
On Mains			2 External fuse F 16 A - 6x30 mm	
On services			//	
On PA Supply			//	
On Driver Supply			//	
HUMAN INTERFACES				
Input device			Touchscreen + 4 pushbutton	
Display			TFT 4.3"	
TELEMETRY / TELECONTROL				
Remote connector inputs	Analog input level	10	FWD fold	For P.A. A.G.C. purpose, min 0.5 Vcc
		2	REF fold	For P.A. A.G.C. purpose, min 0.5 Vcc
	Pulse to GND	14	RF ON	
		15	RF OFF	
	Close to GND	1	Interlock	for remote power inhibition (short is RF off)
Remote connector outputs	Analog output level	6	FWD	max 5 Vcc
		13	REF	max 5 Vcc
		5	VPA	max 5 Vcc

Table of Contents

1. Preliminary Instructions	1
2. Warranty	1
3. First aid	2
3.1 Treatment of electric shocks	2
3.2 Treatment of electrical burns	2
4. General description	3
4.1 Unpacking	3
4.2 Features	4
4.3 Description of the Front Panel	5
4.4 Description of the Rear Panel	6
4.5 Description of the Connectors	7
5. Installation and Configuration Procedure	8
5.1 Installation	9
5.2 Management Firmware	17
6. Identification and Access to the Modules	27
6.1 Identification of the Modules	27
7. Principles of Operation	28
7.1 Panel board	28
7.2 Motherboard	28
7.3 Telemetry Board	29
7.4 Power Supply Block	29
7.5 Power Amplifier Block	29
7.6 Bias Board	30
7.7 Driver Board	30
8. Maintenance and Repair Procedures	31
8.1 Introduction	31
8.2 Safety Considerations	31
8.3 Ordinary maintenance	31
8.4 Replacing the Modules	35
9. Options	47
9.1 Option /AUDIGIN-TFT	47
9.2 Option /RDS-TEX-E-2HE	47
9.3 Option /TLW-TFT-E-2HE	48

Quick guide

1. Turn on the switch on the front panel
2. Set the working frequency via the FRQ menu

To change the value, simply use the **+** or **-** buttons and then confirm with **ENTER** or cancel with **ESC** (in mechanical key mode) or type the value directly on the display (in touchscreen mode).

After setting the desired value, press the **ENTER** button (both in mechanical key and TouchScreen mode) to confirm your choice.

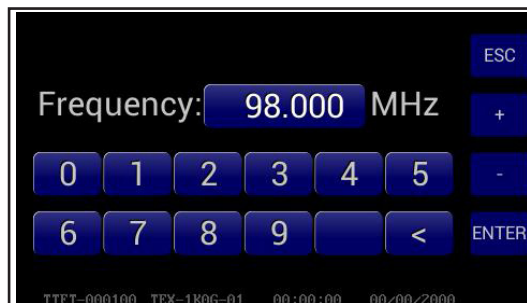

3. Set the output power via the PWR menu

To edit one of the items, select it with the **+** or **-** buttons (the selected item is highlighted) and then press the **ENTER** button (both in mechanical key and TouchScreen mode).

To change the values, simply use the **+** or **-** buttons and then confirm with **ENTER** or cancel with **ESC** (both in mechanical key and TouchScreen mode).

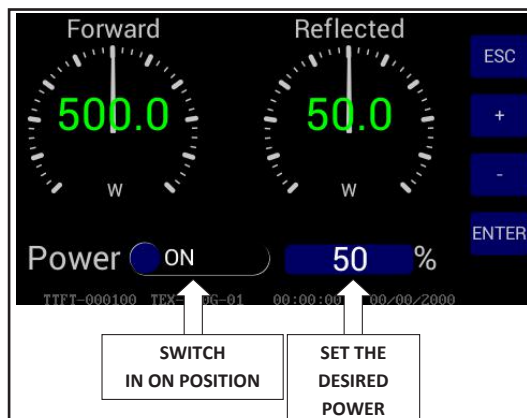

IMPORTANT

The lightning bolt symbol inside a triangle on the product draws attention to operations for which care must be taken to avoid the danger of electric shock.



The exclamation point symbol inside a triangle on the product informs the user of the presence of instructions in the manual accompanying the equipment, which are important for operation and maintenance (repairs).

1. Preliminary Instructions

• General Notices

The equipment in question is to be considered for use, installation and maintenance by “trained” or “qualified” personnel aware of the risks associated with working on electrical and electronic circuits.

The definition of “trained” means personnel with the technical knowledge required to use the device in a manner that ensures their own safety and that of other unqualified personnel under their direct supervision when working on the equipment.

The definition of “qualified” means personnel with the training and experience required to use the device in a manner that ensures their own safety and that of other unqualified personnel under their direct supervision when working on the equipment.

 **CAUTION:** The device may be equipped with an **ON/OFF switch which may not completely remove voltage inside the device. It is necessary to disconnect the power cord, or turn off the power panel, before carrying out technical work, making sure that the safety earth connection is connected.**

Technical work that involves inspection of the device with live circuits must be carried out by trained and qualified personnel in the presence of a second trained person who is ready to intervene by disconnecting the power supply in case of need.

R.V.R. Elettronica assumes no responsibility for injury or damage caused by improper or incorrect use by personnel, whether trained and qualified or not.

 **CAUTION:** The device is not resistant to the ingress of water and infiltration could seriously compromise its correct performance. To prevent fire or electric shock, do not expose this equipment to rain, infiltration or moisture.

Please observe local regulations and fire regulations when installing and using this equipment.

 **CAUTION:** The device in question has internal parts that pose the risk of electric shock: always disconnect the power supply before removing the covers or any other part of the equipment.

Ventilation slots and holes are provided to ensure reliable operation of the product and to protect it from overheating. These slots must not be obstructed or covered. The slots must not be obstructed under any circumstances. The product should not be incorporated into a rack unless it is provided with adequate ventilation or the manufacturer's instructions have been followed.

 **CAUTION:** This equipment can radiate radio frequency energy, and if not installed in accordance with the instructions in the manual and the regulations in force it can interfere with radio communications.

 **CAUTION:** This equipment has an earth connection on both the power cord and the chassis. Make sure they are connected correctly.

Operating this appliance in a residential environment can cause radio disturbances; in this case, the user may be required to take appropriate measures.

The specifications and information given in this manual are provided for informational purposes only, and may therefore be subject to change at any time without notice and should not be seen as binding to **R.V.R. Elettronica**.

R.V.R. Elettronica assumes no responsibility or liability for any errors or inaccuracies that may appear in this manual, including the products and software described in it; and reserves the right to make changes to the design and/or technical specifications of the equipment, as well as to this manual, without prior notice.

• **Notice regarding the intended use and limitations on use of the product.**

This product is a radio transmitter suitable for frequency modulated audio broadcasting service. It uses operating frequencies that are not harmonized in the designated user states.

The user of this product must obtain specific authorization for use of the radio spectrum from the spectrum management authority of the designated user state, before putting this equipment into operation.

The operating frequency, the power of the transmitter, as well as other characteristics of the transmission system, are subject to limitations and are set out in the authorization obtained.

2. Warranty

R.V.R. Elettronica guarantees the absence of manufacturing defects and the proper functioning of the products, within the terms and conditions provided.

Please read the terms carefully, because purchasing the product or accepting the order confirmation constitutes acceptance of the terms and conditions.

For the latest updates on the legal terms and conditions, please visit our website (WWW.RVR.IT) which can also be modified, removed or updated for any reason without notice.

The warranty will be void in the event of opening the equipment, physical damage, misuse, modification, repair by unauthorized persons, carelessness and use for purposes other than those intended.

In the event of a defect, proceed as described below:

- 1 Contact the retailer or distributor from whom the equipment was purchased; describe the issue or malfunction to verify if there is a simple solution.

Retailers and Distributors are able to provide all information relating to the most common issues; they can usually repair the equipment much faster than the manufacturer could. Installation errors can normally be identified directly by retailers.

- 2 if your retailer cannot help you, contact **R.V.R. Elettronica** and describe the issue; if the staff deems it necessary, the authorization to send the equipment will be sent to you with the appropriate instructions;

- 3 Once you have received authorization, you can return the unit. Pack it carefully for shipping, preferably using the original packaging and duly sealing the package.

The customer always assumes the risks of loss (i.e., R.V.R. is never liable for damage or loss), until the package reaches the R.V.R. facility. For this reason, we suggest that you insure the goods for their full value. The goods must be shipped, using C.I.F. values (PAID IN ADVANCE), to the address specified by the R.V.R. service manager on the authorization.



The equipment must not be returned without the authorization for sending as it may be returned to the sender.

- Make sure to include a descriptive technical report mentioning any issues encountered and a copy of your original invoice indicating the date from which the warranty is valid.

Spare parts and parts under warranty can be ordered at the following address. Make sure to include the model and serial number of the equipment, as well as the description and number of spare parts.



R.V.R. Elettronica
Via del Fonditore, 2/2c
40138 BOLOGNA ITALY
Tel. +39 051 6010506

3. First aid

Personnel entrusted with installation, use, and maintenance of the equipment must be familiar with first aid theory and practices.

3.1 Treatment of electric shocks

3.1.1 If the victim has lost consciousness

Follow the first aid principles below.

- Place the victim lying on their back on a hard surface.
- Open the airway by lifting the neck and pushing the forehead back (**Figure 1**).

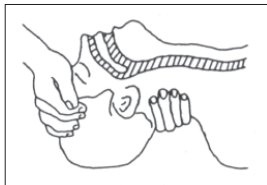

Figure 1

- If necessary, open their mouth and check their breathing.
- If the victim is not breathing, start artificial respiration immediately (**Figure 2**): tilt the head, close the nostrils, make your mouth adhere to that of the victim and perform 4 quick breaths.



Figure 2

- Check the heart rate (**Figure 3**); in the absence of a heartbeat, immediately begin heart massage (**Figure 4**) by compressing the sternum approximately in the centre of the chest (**Figure 5**).

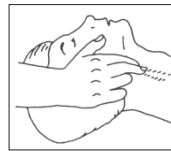

Figure 3

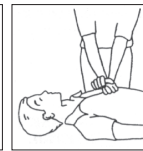

Figure 4

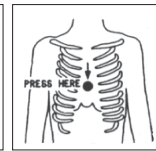

Figure 5

- In the case of only one rescuer, this person must maintain a rhythm of 15 compressions alternating with 2 quick breaths.
- In the case of two rescuers, the rhythm must be one breath every 5 compressions.
- Do not interrupt heart massage during artificial respiration.
- Call a doctor as soon as possible.

3.1.2 If the victim is conscious

- Cover the victim with a blanket.
- Try to keep the victim calm.
- Loosen the clothes and place the victim in a lying position.
- Call a doctor as soon as possible.

3.2 Treatment of electrical burns

3.2.1 Extensive burns and cuts to the skin

- Cover the affected area with a clean sheet or cloth.
- Don't break blisters; remove fabric and items of clothing adhering to the skin; apply a suitable ointment.
- Treat the victim as required for the type of injury.
- Transport the victim to the hospital as quickly as possible.
- If the arms and legs have been affected, keep them elevated.

If medical help is unavailable for an hour and the victim is conscious and not retching, administer a liquid solution of salt and baking soda: 1 teaspoon of salt and half a teaspoon of baking soda for every 250ml of water.

Slowly drink about half a glass of solution four times over a period of 15 minutes. Discontinue if retching occurs.

Do not give alcohol.

3.2.2 Less serious burns

- Apply cold (not icy) gauze compresses using as clean a cloth as possible.
- Don't break blisters; remove fabric and items of clothing adhering to the skin; apply a suitable ointment.
- If necessary, put on clean and dry clothes.
- Treat the victim as required for the type of injury.
- Transport the victim to the hospital as quickly as possible.
- If the arms and legs have been affected, keep them elevated.

4. General description

The **TEX1002TFT**, produced by R.V.R. Elettronica, is a **compact transmitter for frequency modulation broadcasting** capable of transmitting in the 87.5 to 108 MHz band in 10kHz steps, with an adjustable RF output up to a maximum of 1000 W with a standard load of 50 Ohm.

The unit is factory aligned and calibrated at the time of manufacture. Due to this manufacturing process, no field tuning or alignment is required.

The unit is factory set and calibrated at the time of manufacture. As a result of this manufacturing process, no tuning or adjustment is required.

The factory tolerances are:

- **Maximum rated output power:** 60 dBm \pm 1 dB
- **Minimum rated output power:** 50 dBm \pm 1 dB
- **Gain :** Not applicable (the equipment is supplied without a radiant system, which is the customer's responsibility).

The **TEX1002TFT** is designed to be contained in a 2HE 19" rack box.

4.1 Unpacking

The package contains the following:

- 1 **TEX1002TFT**
- 1 Compliance Documentation
- 1 Power connector

You can also obtain the following accessories for the equipment from your R.V.R. retailer:

- **Options for the equipment:** /AUDIGIN-TFT, /RDS-TEX-2HE, /RDS-TEX-E-2HE and /TLW-TEX-E-2HE

	/AUDIGIN-TFT	/RDS-TFT-2HE	/RDS-TEX-E-2HE	/TLW-TFT-E-2HE
/AUDIGIN-TFT		•	•	•
/RDS-TFT-2HE	•		X	•
/RDS-TEX-E-2HE	•	X		•
/TLW-TFT-E-2HE	•	•	•	

•: compatible option / o: option already included / x : not compatible option

Table 4.1: table of compatibility of the various options

- **Spare parts**
- **Cables**

4.2 Features

The overall efficiency of the **TEX1002TFT** is over 70% over the entire band, which is why it is part of the RVR Green Line family.

This performance characteristic is guaranteed in a range between + 0.25dB and -3 dB (+ 5% and -50%) with respect to the nominal power of the equipment: from 500W to 1050W for example in the case of the **TEX1002TFT**; beyond these limits the equipment is able to function correctly but cannot guarantee a performance of 70%.

This transmitter contains a low-pass filter that reduces harmonic emissions below the limits allowed by international regulations (CCIR, FCC or ETSI) and can be connected directly to the antenna.

The salient features of the **TEX1002TFT** are compactness and great ease of use. Furthermore, the equipment is designed in a modular way: the various functions are performed by modules connected mostly with male and female connectors or with flat cables terminated by connectors. This type of design facilitates maintenance operations and the possible replacement of modules.

The RF power section uses for the **TEX1002TFT** an LD-MOS module capable of delivering up to 1000W with an efficiency of about 80%.

The working frequency is guaranteed by a reference oscillator that is temperature-compensated and maintained by a PLL (Phase Locked Loop) system. The exciter reaches the frequency lock in a maximum time of thirty seconds from power on.

The **TEX1002TFT** is able to work on the whole frequency band without requiring calibration and setting operations.

The microprocessor control system includes a TFT touchscreen display on the front panel and an emergency push-button panel with the following functions:

- Enabling/disabling of the output power.
- Setting the output power level.
- Setting the working frequency.
- Setting the audio parameters
- Setting the power output alarm threshold (“Power Good” function).
- Measurement and display of transmitter operating parameters.
- Communications with external devices such as programming systems or telemetry systems via RS232 or I²C serial interface.

Five LEDs on the front panel provide the following status indications: **ON**, **LOCK**, **FOLDBACK** and **RF MUTE**.

The exciter management firmware is based on a menu system. The user can navigate between the different submenus using the touchscreen or the four buttons: **ESC**, \leftarrow , \downarrow , \rightarrow , and **ENTER**.

On the rear panel there are the network input connectors, the audio input connectors and the RF output connector, the telemetry connector, the protection fuses, two inputs for signals modulated on sub-carriers by special external encoders, normally used in Europe for RDS (Radio Data System) broadcasting.

4.3 Description of the Front Panel

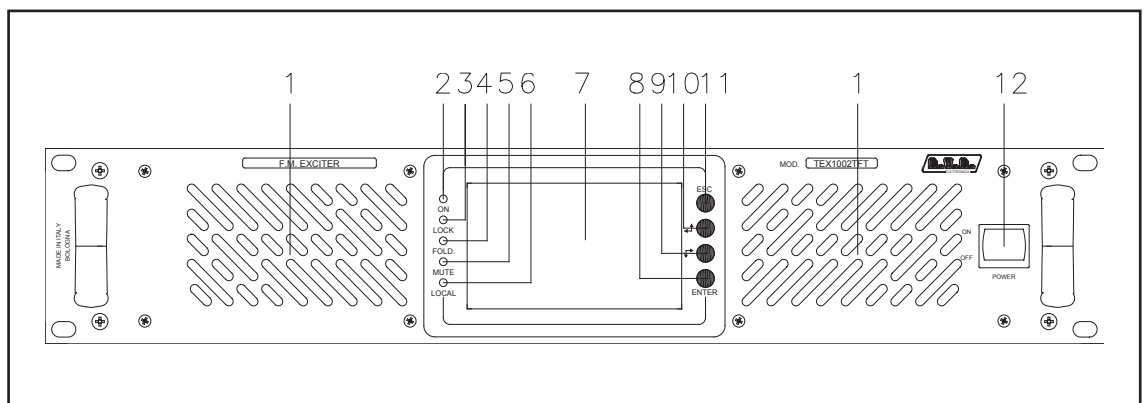

Figure 4.1

[1] AIR FLOW	Grids for forced ventilation.
[2] ON	Green LED, lit when the transmitter is power enabled.
[3] LOCK	Green LED, lit when the PLL is locked to the working frequency.
[4] FOLD.	Yellow LED, lit when the limitation function intervenes (foldback).
[5] MUTE	Yellow LED, lit when the transmitter is not delivering power because it is inhibited by an external interlock.
[6] LOCAL	Yellow LED, illuminated when the exciter is set to Local mode.
[7] DISPLAY	TFT display with touchscreen.
[8] ENTER	Button for confirming a parameter and for entering the menus.
[9] \downarrow	Button for navigating the menu system and for changing parameters.
[10] \uparrow	Button for navigating the menu system and for changing parameters.
[11] ESC	Button to be pressed to exit a menu.
[12] POWER	ON/STAND-BY switch.

4.4 Description of the Rear Panel

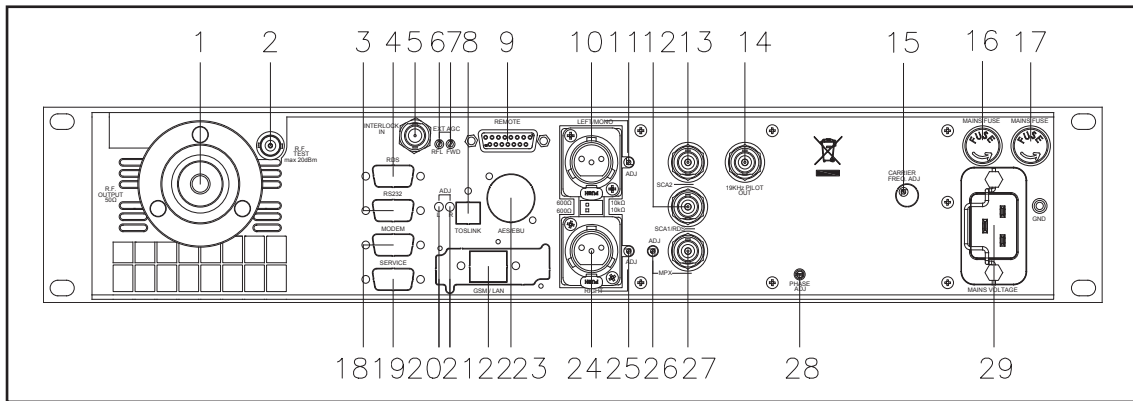

Figure 4.2

- | | |
|------------------------------------------------------------------------------------------------------------------------------------------------------------------------------------------------------------------------------------------------------------------------------------------------------------------------------------------------------------------------------------------------------------------------------------------------------------------------|-------------------------------------------------------------------------------------------------------------------------------------------------------------------------------------------------------------------------------------------------------------------------------------------------------------------------------------------------------------------------------------------------------------------------------------------------------------------------------------------------------------------------------------------------------------------------------------------------------------------------------------------------------------------------------------------------------------------------------------------------------------------------------------------------------------------------------------------------------------------------------------------------------------------------------------------------------------------------------------------------------------------------------------------------------------------------------------------------------------------------------------------------------------------------------------------------------------------------------------------------------------------------------------------------------------------------------------------------------------------------------------------------------------------------------------------------------------------------------------------------------------------------------------------------------------------------------------------------------------------------------------------------------------------------------------------------------------------------------------------------------------------------------------------------------------------------------------------------|
| <p>[1] R.F. OUTPUT
[2] R.F. TEST</p> <p>[3] RS232</p> <p>[4] RDS
[5] INTERLOCK IN</p> <p>[6] RFL EXT. AGC
[7] FWD EXT. AGC</p> <p>[8] TOSLINK</p> <p>[9] REMOTE
[10] LEFT/MONO</p> <p>[11] LEFT/MONO ADJ
[12] SCA1/RDS
[13] SCA2
[14] 19 kHz PILOT OUT</p> <p>[15] CARRIER FREQ. ADJ
[16] MAIN FUSE
[17] MAIN FUSE
[18] MODEM</p> <p>[19] SERVICE
[20] L ADJ</p> <p>[21] R ADJ</p> <p>[22] GSM/LAN</p> <p>[23] AES/EBU</p> | <p>RF output connector, 7/8" EIA type Flange, 50Ω.</p> <p>RF test output, about -60dBc compared to the RF output power level, suitable for modulation monitoring. Not usable for spectral analysis.</p> <p>DB9 connector for serial communication, either direct or with modem (only with telemetry option).</p> <p>Multifunction DB9 connector (only with internal RDS option). Incoming interlock BNC connector: by grounding the central conductor, the transmitter is forced into stand-by mode.</p> <p>Trimmer for regulation of the limitation of delivered power according to the RFL fold input.</p> <p>Trimmer for regulation of the limitation of delivered power according to the FWD fold input.</p> <p>TOS-LINK connector for optical fibre digital audio input (only with Digital Audio option).</p> <p>DB15 connector for telemetry of the device.</p> <p>XLR connector for the balanced audio input of the left-mono channel.</p> <p>Left-mono input level adjustment trimmer.</p> <p>Unbalanced SCA1/RDS input BNC connector.</p> <p>BNC connector for unbalanced SCA2 input.</p> <p>Pilot tone output BNC connector, which can be used to synchronize external devices such as the RDS coder.</p> <p>Fine adjustment trimmer for the transmission frequency.</p> <p>Fuse for mains power supply.</p> <p>Fuse for mains power supply.</p> <p>DB9 connector connected to the internal GSM modem (only with telemetry option).</p> <p>Reserved for future use.</p> <p>Left digital input level adjustment trimmer (only with Digital Audio option).</p> <p>Right digital input level adjustment trimmer (only with Digital Audio option).</p> <p>GSM modem or RJ45 connector for TCP/IP communications (only with telemetry options).</p> <p>XLR connector for AES/EBU digital audio input (only with Digital Audio option).</p> |
|------------------------------------------------------------------------------------------------------------------------------------------------------------------------------------------------------------------------------------------------------------------------------------------------------------------------------------------------------------------------------------------------------------------------------------------------------------------------|-------------------------------------------------------------------------------------------------------------------------------------------------------------------------------------------------------------------------------------------------------------------------------------------------------------------------------------------------------------------------------------------------------------------------------------------------------------------------------------------------------------------------------------------------------------------------------------------------------------------------------------------------------------------------------------------------------------------------------------------------------------------------------------------------------------------------------------------------------------------------------------------------------------------------------------------------------------------------------------------------------------------------------------------------------------------------------------------------------------------------------------------------------------------------------------------------------------------------------------------------------------------------------------------------------------------------------------------------------------------------------------------------------------------------------------------------------------------------------------------------------------------------------------------------------------------------------------------------------------------------------------------------------------------------------------------------------------------------------------------------------------------------------------------------------------------------------------------------|

[24] RIGHT	XLR connector for the balanced audio input of the right channel.
[25] RIGHT ADJ	Right input level adjustment trimmer.
[26] MPX ADJ	MPX input level adjustment trimmer.
[27] MPX	Unbalanced MPX input BNC connector.
[28] PHASE ADJ	Phase adjustment trimmer.
[29] MAINS	VDE connector for mains power supply, 230 V (+/- 15%) 50-60 Hz.

4.5 Description of the Connectors

4.5.1 Left (MONO) / Right

Type: XLR female



- 1 GND
- 2 Positive
- 3 Negative

4.5.2 Remote

Type: DB15 female

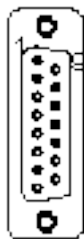

Pin	Name	Type	Meaning
1	Interlock	IN	Inhibits if power is closed to GND
2	Ext AGC FWD	IN	External signal, 1-12V, for limitation (AGC)
3	GND		Ground
4	SDA IIC	I/O	Serial data for IIC communications
5	VPA TIm	ANL OUT	Power supply PA: 3.9V F.S.
6	FWD TIm	ANL OUT	Forward power: 3.9V F.S.
7	Power Good	DIG OUT	Reports activation by bringing the contact, normally open, to ground.
8	GND		Ground
9	GND		Ground
10	Ext AGC RFL	IN	External signal, 1-12V, for limitation (AGC)
11	SCL IIC	I/O	Clock for IIC communication
12	IPA TIm	ANL OUT	PA power supply current: 3.9V F.S.
13	RFL TIm	ANL OUT	Reflected power: 3.9V F.S.
14	On cmd	DIG IN	A pulse to ground (500 ms) activates power delivery
15	OFF cmd	DIG IN	A pulse to ground (500 ms) inhibits power delivery.

5. Installation and Configuration Procedure

Instructions are given in this chapter on installation and configuration of the equipment. Carefully perform all the steps described in this chapter both upon initial start-up and every time the main configuration is changed, for example when moving to a new transmission station or when replacing the equipment.



IMPORTANT: *always disconnect the mains power before carrying out any type of installation and/or maintenance. It is imperative to cut off the power supply to avoid electric shock hazards that could cause damage to property and physical harm, serious injuries or even death.*

The equipment must only be installed by qualified personnel.

Qualified personnel are personnel who comply with all the safety directives, laws and standards that apply to the installation and operation of this device.

The choice of qualified and duly trained personnel is always the responsibility of the employer, since the employer is always the one in the best position to judge whether a worker is suitable for a particular job and therefore capable of ensuring their safety while respecting the applicable law on occupational safety.

Employers must provide their personnel with adequate training in electrical devices, and ensure that they are familiar with the content of this manual.

Compliance with the safety instructions set out in this manual or with the legislation indicated does not relieve the personnel from the duty to also comply with other specific standards relating to the installation, place, country or other circumstances concerning the equipment.



IMPORTANT: *there is a danger of possible electric shocks and it is therefore mandatory to comply with the applicable safety law regarding electrical aspects.*

Once configured, the equipment is ready for normal operation and no further intervention is required since all the parameters are saved automatically for when the equipment is switched off and on again either intentionally or unintentionally.

The performance and functions of the hardware and firmware of the equipment are described in more detail in the following chapters: please refer to the relevant sections of the manual for further information on what is covered in this chapter.



IMPORTANT: *during all phases of configuration and testing of the transmitter of which this equipment forms part, always keep to hand the test table (“Final Test Table”) accompanying the equipment: this document covers all the operating parameters of the equipment set and checked at the time of testing after production.*

5.1 Installation

5.1.1 General Requirements

The ventilation of the equipment and workplace must be suitable for maintenance according to the directive in force in the country in which this equipment is installed.

To ensure correct operation of the appliance, there must be a clearance of at least 50 cm at the front and back of the device to facilitate the circulation of air through the ventilation grids.

In any case, the clearances must be in accordance with the safety directive in force in the country where this equipment is installed.

This device has been designed to operate at temperatures between -10 °C and 45 °C without loss of performance. The ambient air must be dust-free and not condensed; the maximum humidity must never exceed 95%.

In particular environmental conditions it should be remembered that temperature fluctuations can cause condensation. If the place where this device is located should be subject to these physical events, it is advisable to monitor the device once it is put into service, in addition to trying to protect the device itself as best as possible.



IMPORTANT: *never power up the equipment in the presence of condensation. This problem can occur more frequently in the case of equipment stored for a long time or used as active backup.*

The RF antenna, power supply and connection cables must have a section suitable for the maximum current intensity.

5.1.2 Preliminary checks

Unpack the appliance by removing the wrapping and, before any other operation, check for any damage due to transport. Carefully check that all connectors are in perfect condition and verify the absence of moisture. Otherwise, wait until it is completely dry.

If any issues occur during this first phase, contact the after-sales service immediately.

The main fuse is accessible from the outside on the rear panel. Remove the fuse block with a screwdriver to check its condition and replace it if necessary. The fuses to be used are:

	TEX1002TFT @ 230 Vac
Main fuse	(2x) F 10A type 6x30

Table 5.1: Fuses

5.1.2 Placement of the device

Useful tips for correct installation:

- Avoid the presence of external elements near the ventilation inlets and outlets, as they could prevent proper ventilation of the device.
- Avoid proximity to a source of heat or flammable gas.
- Limit places subject to accumulation of humidity, dust, sand or salt or environments that could compromise correct operation of the equipment.
- Avoid installing the equipment in inhabited places due to possible noise pollution, or on lightweight supports. The device may hum during operation due to forced ventilation. The mounting surface must be able to withstand the weight of the device and must be solid.



Note: below we will refer to a complete station of which the device can form a part. The same procedures also apply if the device is used as a standalone one.

The device is generally connected inside a 19" rack and fixed with M5 screws in the designated holes.

The device must be installed at least 1 metre from the ground.

Install the rack where the transmitter will be operated. The rack is mounted on wheels for ease of movement: once it is put into position it is advisable, therefore, to use the four screws at the base of the rack to stabilize it perpendicular to the ground.

The environment where the rack is installed should be air conditioned at about 25 °C and equipped with a filter for the elimination of dust and salt.



The station normally has an air outlet at the rear of the equipment: in which case, ensure adequate ventilation of the room.

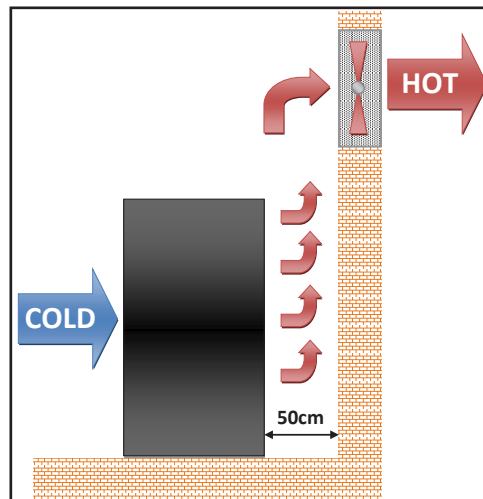

Alternatively it is cooled by forced ventilation and the air intake is located on the roof of the equipment. A hose approximately 1.5 metres in length is recommended.

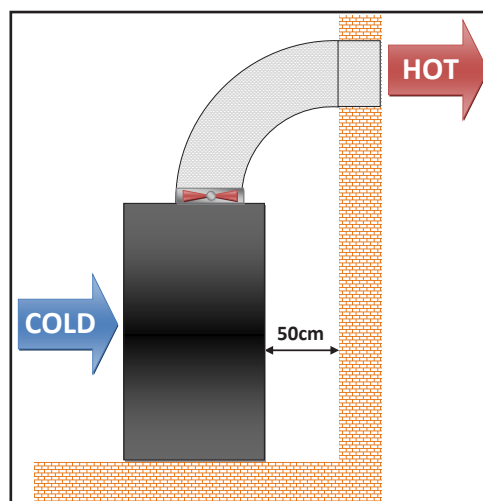

It is strongly recommended to install the rack at least 50 cm from the rear and side walls in order to allow optimal air flow and ease of maintenance.

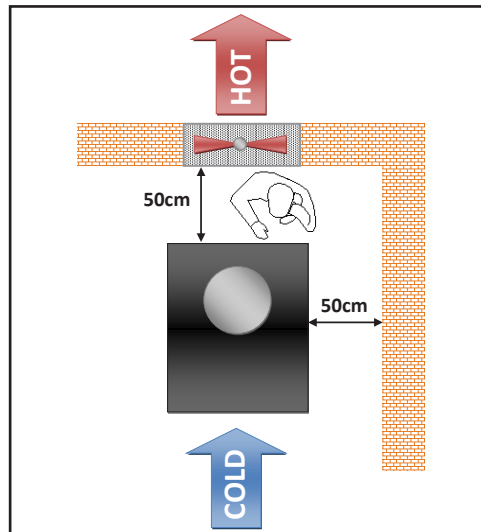

5.1.3 Power supply connections of the device

Prepare the following connection (valid for both functional tests and final commissioning):

- √ Single-phase mains power connector, 230 (-15% / + 10%) Vac. A conductor section of at least 2.5 mm² is recommended.

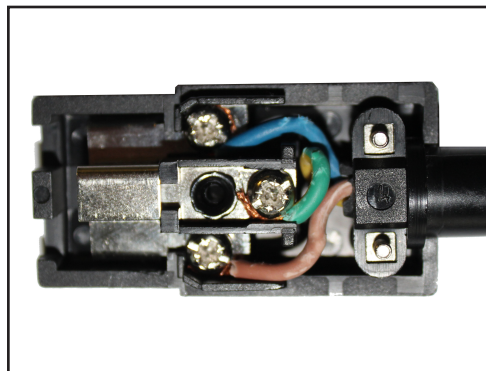

Internal connector wiring



Note: to ensure the safety of the operators, prepare the wiring according to the laws and regulations in the country where this equipment is installed.

Check that the **POWER** switch on the front panel of the **TEX1002TFT** is in the “**OFF**” position.

Connect the network cable to the appropriate **MAINS** socket on the rear panel.



Caution: To avoid the **risk of damaging the equipment**, it is essential that this is properly earthed. It is mandatory, therefore, to check the efficiency of the earth connection of your system.

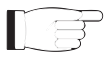

Note: to ensure both the safety of the operators and correct operation of the equipment, it is essential that the mains system is earthed and properly connected to the equipment.

Useful tips for a correct connection:

- Prepare suitable earthing of the electrical system. This offers both direct protection, as it prevents shocks when direct contact is made with the metal casings of the equipment, and indirect protection, as it cuts off the supply of energy when dispersion occurs due to poor insulation. This can be done independently also with an earthing rod and inspection pit installed by the qualified personnel of a specialised company.
- Provide internal lightning protection such as a surge arrester (internal SPD) or a circuit breaker, to be installed by qualified personnel in the distribution panel. This solution allows to protect from violent atmospheric electric discharges that hit the surrounding ground up to several kilometres.
- Provide internal protection against disturbances on the distribution line such as EMI filters or line voltage stabilizers, to be installed by qualified personnel in the distribution panel, which can filter disturbances caused by electrical equipment and sudden surges on the line, as well as permit voltage control.

5.1.4 Audio and RF connections

Prepare the following connection (valid for both functional tests and final commissioning):

√ For functional tests only:

- a dummy load with 50 Ohm impedance and of appropriate power (minimum 1000W for **TEX1002TFT**).
- Coaxial cable with BNC connectors for connecting the interlock signal to the load protection.

√ Connection cable kit including:

- RF cable for the output towards the load / antenna (50 Ohm coaxial cable with standard 7/8" type connector).
- Audio cables between transmitter and audio signal sources.



CAUTION: risk of burns due to RF. Before connecting the antenna cable, make sure that the equipment cannot emit RF at the output.



CAUTION: For reasons of electromagnetic compatibility, only double shielded cables should be used at the RF output.

Obtain a 7/8" 50 Ohm RF cable for the connection between the Antenna and the device; the part that goes towards the device must be equipped with a 7/8" EIA connector.

Connect the RF output of the transmitter to the antenna cable or to a dummy load capable of dissipating the power generated by the amplifier.

Initially adjust to minimum output power and turn it off.



CAUTION: To avoid electric shocks and electrocution, never touch the RF output connector when the equipment is powered up and with no load connected.

Check that the **POWER** switch on the front panel of the **TEX1002TFT** is in the "OFF" position.

Connect the audio and RDS/SCA cables of your sources to the input connectors.



Note: to ensure both the safety of the operators and correct operation of the equipment, it is essential that the mains system is earthed and properly connected to the equipment.

5.1.5 Initial start-up and setting of operation

For initial start-up, follow the procedure below.



Note: RF EXPOSURE SAFETY DISTANCE (only for FCC & IC)

*RF Exposure Limits for the United States of America, according to FCC regulation: Set the output power of the unit to maximum to ensure the exposure limits stated in this document. The gain of the antenna used with this device must be 0 dBi or less and all people must maintain a minimum safety distance of **638.41 cm**.*



*Radio Frequency Exposure Limits for Canada, according to IC regulation: set the output power of the unit to maximum to ensure the exposure limits stated in this document. The gain of the antenna used with this device must be 0 dBi or less and all people must maintain a minimum safety distance of **785.90 cm**.*

5.1.5.1 Power on

After making the connections described above, turn on the device at the power switch on the front.

The default screen appears on the display and when the **PLL** is locked to the working frequency, the **LOCK** LED lights up.

5.1.5.2 Setting the working frequency

Access the **FRQ** menu and use the touchscreen or keys  and  to adjust the working frequency of the equipment.

Press **ENTER** to confirm and wait for the **LOCK** LED to come on again.

5.1.5.3 Enabling the RF output



If the power readings are zero, enable the RF output:

- Access the **PWR** menu and check that the output power level is different from 0%.
- Check the status of the output power, **Power**. Set the status to **ON** and make sure that the **ON** LED comes on.

5.1.5.4 Checking the output power level





IMPORTANT: *The equipment has automatic level control (ALC) and the output power is delivered based on the level adjusted by the user and the actual working conditions, such as temperature, reflected power and other parameters. Please read the section on RF power feedback.*

Access the **PWR** menu and use the touchscreen or keys  and  to adjust the output power of the equipment in steps of 1%; considering that the forward power value indicated on the display (**Forward**) provides the real reading of the output power.



Note: *If the output power does not match the set value, some feedbacks may be active that limit the output.*

5.1.5.5 Modulation adjustments

To modify the levels and operating modes of the equipment, access the **AUD** menu and use the touchscreen or keys  and  to adjust the various settings.



Note: *On the rear panel of the device there are trimmers for the fine adjustment of some inputs of the equipment and the screen printed diagram indicates which input each trimmer refers to.*

The sensitivity of the various inputs can be adjusted with the limitations described in the following table:

Input	Sensitivity	Notes
SCA1/RDS	- 9,2 ÷ +12 dBu	Input level for 3,5 kHz overall deviation (-30 dB)
SCA2	- 9,2 ÷ +12 dBu	
MPX	-12,5 ÷ +13,3 dBu	Input level for 75 kHz overall deviation (0 dB)
Left/Mono	-12,7 ÷ +13,2 dBu	
Right	-12,7 ÷ +13,2 dBu	
Pilot	-70,6 ÷ -17,6 dB	Absolute level overall deviation (normally - 20 dB)



Note: When adjusting the sensitivity level of the inputs, keep in mind that the menu shows the instantaneous modulation level. For correct adjustment, it is therefore advisable to apply to the input a dBm signal with a level equal to the entered dBu level.

To adjust the levels of the inputs of the sub-carriers, a similar procedure can be used, using the option **x10** that can be selected in the **MIX** menu. With this option, the indicated modulation level is multiplied by a factor of 10. The indication of 75 kHz actually coincides with a deviation value of 7.5 kHz.

5.2 Management Firmware

The device has a TFT touchscreen display, on which a set of menus are shown which indicate all the operating parameters of the product.

To navigate the menus, use the touchscreen or the four mechanical keys that operate in the same way. An overall view of the menus is given in figure 5.2.

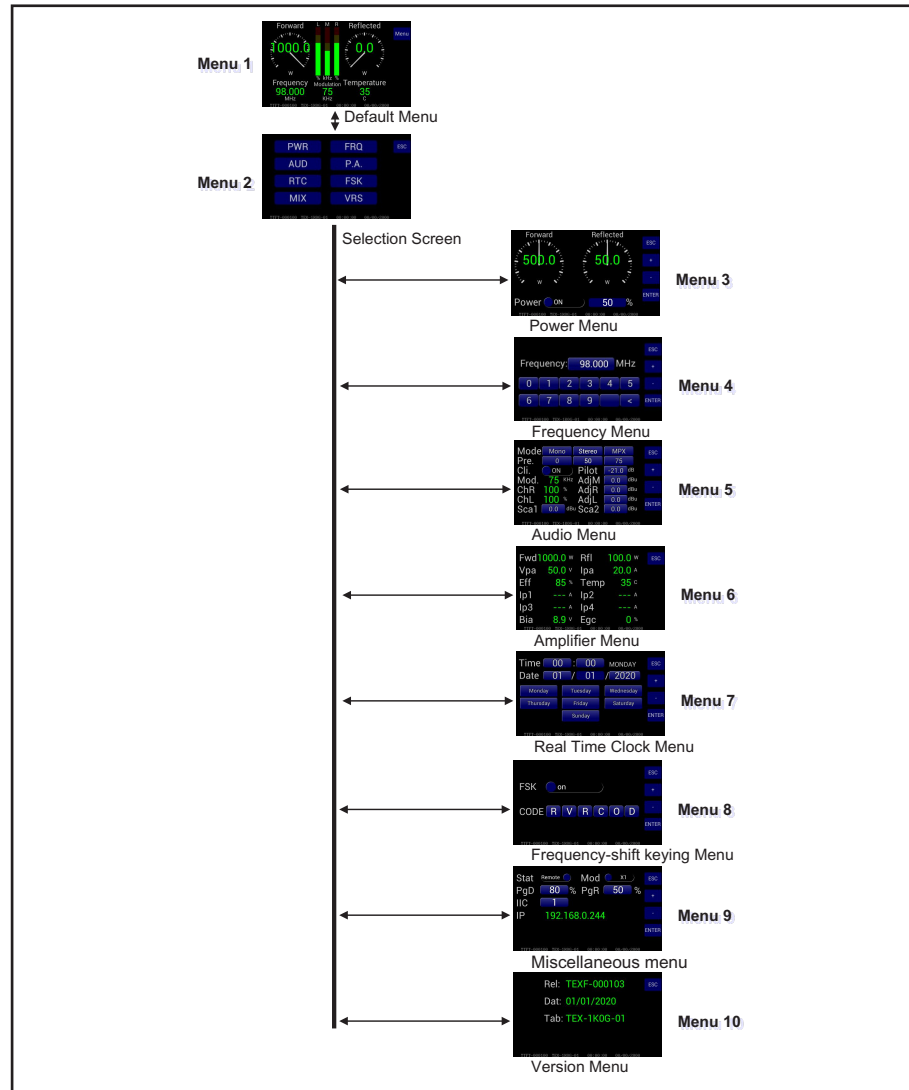
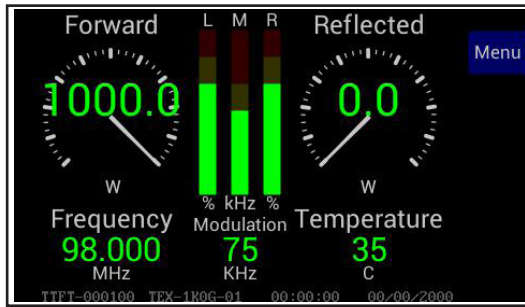

Figure 5.2

5.2.1 Default Menu and Selection Screen

Power on the transmitter. The TFT display will show a first initialization screen for a few seconds followed by the **default** menu (menu 1) which shows the basic parameters of the device.



Menu 1



NOTE: in power saving mode, the **Menu key** becomes **ESC**: press it to exit this mode.

Pressing the **ESC** button (both in mechanical key and TouchScreen mode) while in the **default menu** (menu 1) opens the **selection screen** (menu 2), from which it is then possible to access all the other menus:



Menu 2

To enter one of the menus, select the name with the **+** or **-** buttons (the selection is highlighted) and then press the **ENTER** button (in mechanical key mode) or press the item directly on the display (in TouchScreen mode).

If you want to go back to the **default menu** (menu 1), simply press the **ESC** button again (both in mechanical key and TouchScreen mode) or wait two minutes for automatic exit.

5.2.2 Power Menu (PWR)

This screen shows the user the parameters relating to the power delivery of the device.

To edit one of the items, select it with the **+** or **-** buttons (the selected item is highlighted) and then press the **ENTER** button (both in mechanical key and TouchScreen mode).

To change the values, simply use the **+** or **-** buttons and then confirm with **ENTER** or cancel with **ESC** (both in mechanical key and TouchScreen mode).

At any time it is possible to return to the **selection screen** (menu 2) by pressing the **ESC** button (both in mechanical key and TouchScreen mode) or after one minute of inactivity; the selection will remain set to the previous value.

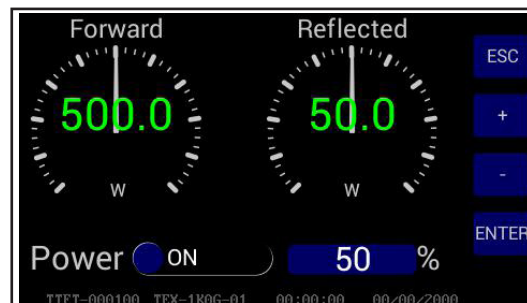

Menu 3

Forward

Shows the forward power.

Reflected

Shows the reflected power.

Power

Enables (ON) or disables (OFF) power delivery.

%

Setting of forward power as a percentage.

5.2.3 Frequency Menu (FRQ)

This menu allows you to read and set the working frequency.

To change the value, simply use the **+** or **-** buttons and then confirm with **ENTER** or cancel with **ESC** (in mechanical key mode) or type the value directly on the display (in touchscreen mode).

After setting the desired value, press the **ENTER** button (both in mechanical key and TouchScreen mode) to confirm your choice.

At any time it is possible to return to the **selection screen** (menu 2) by pressing the **ESC** button (both in mechanical key and TouchScreen mode) or after one minute of inactivity; the selection will remain set to the previous value.



Menu 4

Frequency

Adjustment of the set frequency.

5.2.4 Audio menu (AUD)

This menu allows you to read and set the parameters relating to the audio section.

To change the value, simply use the **+** or **-** buttons and then confirm with **ENTER** or cancel with **ESC** (in mechanical key mode) or type the value directly on the display (in touchscreen mode).

To change the values, simply use the **+** or **-** buttons and then confirm with **ENTER** or cancel with **ESC** (both in mechanical key and TouchScreen mode).

At any time it is possible to return to the **selection screen**(menu 2) by pressing the **ESC** button (both in mechanical key and TouchScreen mode) or after one minute of inactivity.



Menu 5

- Mode Selection of the audio coder mode between mono, stereo or composite mode.
- Pre Selection of the preemphasis configuration expressed in microseconds.
- Cli Enable (ON) or disable (OFF) the status of the clipper.
- Pilot Adjustment of the pilot level expressed in decibels (dB) relative to a modulation of 7.5 kHz.
- Mod. Shows the modulation expressed in kilohertz (kHz).
- AdjM Adjustment of the input level of the MPX channel in decibels (dBu) relative to a 75 kHz modulation.
- ChR Shows the level of the right channel expressed as a percentage.
- AdjR Adjustment of the input level of the right channel expressed in decibels (dBu) relative to a modulation of 75 kHz.
- ChL Shows the level of the left channel expressed as a percentage.
- AdjL Adjustment of the input level of the left channel expressed in decibels (dBu) relative to a modulation of 75 kHz.
- Sca1 Adjustment of the input level of the auxiliary channel expressed in decibels (dBu) relative to a modulation of 3.5 kHz.
- Sca2 Adjustment of the input level of the auxiliary channel expressed in decibels (dBu) relative to a modulation of 3.5 kHz.

5.2.5 Amplifier Menu (PA)

This menu allows you to read the parameters relating to the power amplifier.

At any time it is possible to return to the **selection screen** (menu 2) by pressing the **ESC** button (both in mechanical key and TouchScreen mode) or after one minute of inactivity.

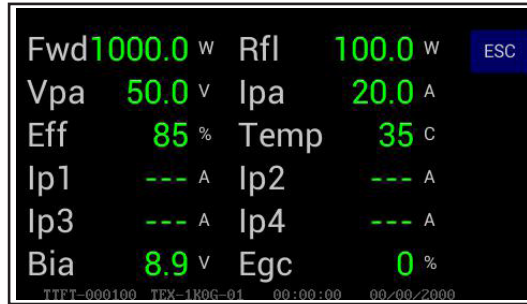

Menu 6

- Fwd Shows the forward power expressed in Watts.
- Rfl Shows the reflected power expressed in Watts.
- VPA Shows the power supply voltage of the RF section expressed in Volts.
- IPA Shows the current absorbed by the RF section expressed in Ampere.
- Eff Shows the efficiency as the ratio between the forward power and the power absorbed by the RF section, expressed as a percentage (FWD/ (Vpa x Ipa)%).
- Temp Shows the internal temperature reading of the equipment expressed in degrees Centigrade.
- Ip 1 Shows the current absorbed by the amplifier module 1 expressed in Ampere.
- Ip 2 Shows the current absorbed by the amplifier module 2 expressed in Ampere.
- Ip 3 Shows the current absorbed by the amplifier module 3 expressed in Ampere.
- Ip 4 Shows the current absorbed by the amplifier module 4 expressed in Ampere.
- Bia Shows the bias voltage of the RF section expressed in Volts.
- Egc Shows the External Gain Control coming from the TELEMETRY connector expressed as a percentage.

5.2.6 Real Time Clock (RTC) menu

This menu allows you to read and set the time and date of the device.

To modify the value, simply use the **+** or **-** buttons and then confirm with **ENTER** or cancel with **ESC** (in mechanical key mode) or type the value directly on the display (in touchscreen mode).

After setting the desired value, press the **ENTER** button (both in mechanical key and TouchScreen mode) to confirm your choice.

At any time it is possible to return to the **selection screen** (menu 2) by pressing the **ESC** button (both in mechanical key and TouchScreen mode) or after one minute of inactivity; the selection will remain set to the previous value.



Menu 7

Time Setting of the hour and minutes on the device (HH:mm).

Date Setting of the date on the device (dd/MM/yy).

Day of Week
Setting of the two events of the selected day.

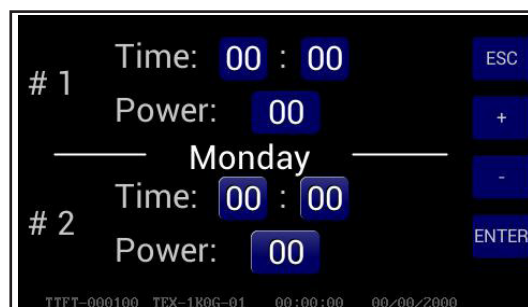

Menu 8

5.2.7 Frequency-shift keying (FSK) menu

This menu provides the FSK (Frequency Shift Keying) adjustments of the exciter.

To modify the value, simply use the **+** or **-** buttons and then confirm with **ENTER** or cancel with **ESC** (in mechanical key mode) or type the value directly on the display (in touchscreen mode).

After setting the desired value, press the **ENTER** button (both in mechanical key and TouchScreen mode) to confirm your choice.

At any time it is possible to return to the **selection screen** (menu 2) by pressing the **ESC** button (both in mechanical key and TouchScreen mode) or after one minute of inactivity; the selection will remain set to the previous value.

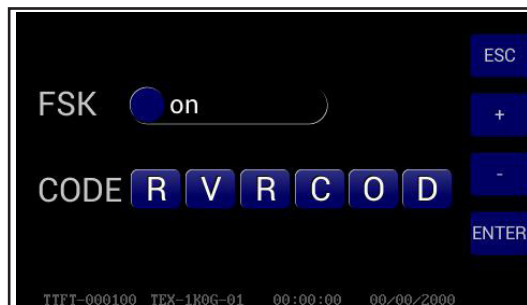

Menu 9

FSK Enable (ON) or disable (OFF) the FSK function.

CODE Setting the Morse code sent.

5.2.8 Miscellaneous Menu (MIX)

This menu allows you to set the address of the device for the serial bus connection, type I²C.

To modify the value, simply use the **+** or **-** buttons and then confirm with **ENTER** or cancel with **ESC** (in mechanical key mode) or type the value directly on the display (in touchscreen mode).

After setting the desired value, press the **ENTER** button (both in mechanical key and TouchScreen mode) to confirm your choice.

At any time it is possible to return to the **selection screen** (menu 2) by pressing the **ESC** button (both in mechanical key and TouchScreen mode) or after one minute of inactivity; the selection will remain set to the previous value.

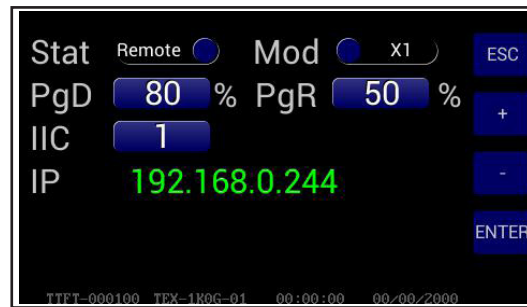

Menu 10

- Stat Enable (Remote) or disable (Local) the commands coming from remote.
 - Stat Enables (x10) or disables (x1) the multiplication function of the instantaneous modulation reading. This display mode is useful when you want to view low levels of deviation.
 - PgD Adjustment of the Power Good threshold relating to the forward power. The percentage value of Power Good refers to the nominal power of the device (1000 W for the **TEX1002TFT**), not to the forward power delivered. So if you set a value equal to 50%, it will correspond to 500 W, regardless of the power set. When the output power drops below the set Power Good threshold value, the device changes the state of pin [7] of the DB15 “Remote” connector on the rear panel.
 - PgR Adjustment of the Power Good threshold relating to the reflected power. The percentage value of Power Good refers to the nominal power of the device (100 W for the **TEX1002TFT** respectively), not to the reflected power delivered. So if you set a value equal to 5%, it will correspond to 5 W respectively, regardless of the power set.
-  **NOTE:** This alarm does not move any contact on the DB15 “Remote” connector.
- IIC I²C network address setting, relevant when the exciter is connected in an RVR transmission system that uses this protocol. However, it is recommended not to modify it without reason.
 - IP Display of the IP address assigned to the device (with / **TLW-TEX-E** option).

5.2.9 Version menu (Vrs)

This screen shows information about the version of the device.

At any time it is possible to return to the **selection screen** (menu 2) by pressing the **ESC** button (both in mechanical key and TouchScreen mode) or after one minute of inactivity.



Menu 11

- Rel Shows the firmware release.
- Dat Shows the Release date.
- Tab Shows the configuration table loaded in the memory.

6. Identification and Access to the Modules

6.1 Identification of the Modules

The **TEX1002TFT** is composed of several modules which are interconnected with connectors to facilitate maintenance and replacement of the modules.

6.1.1 TEX1002TFT Top view

The figure below shows the top view of the device, indicating the various components.

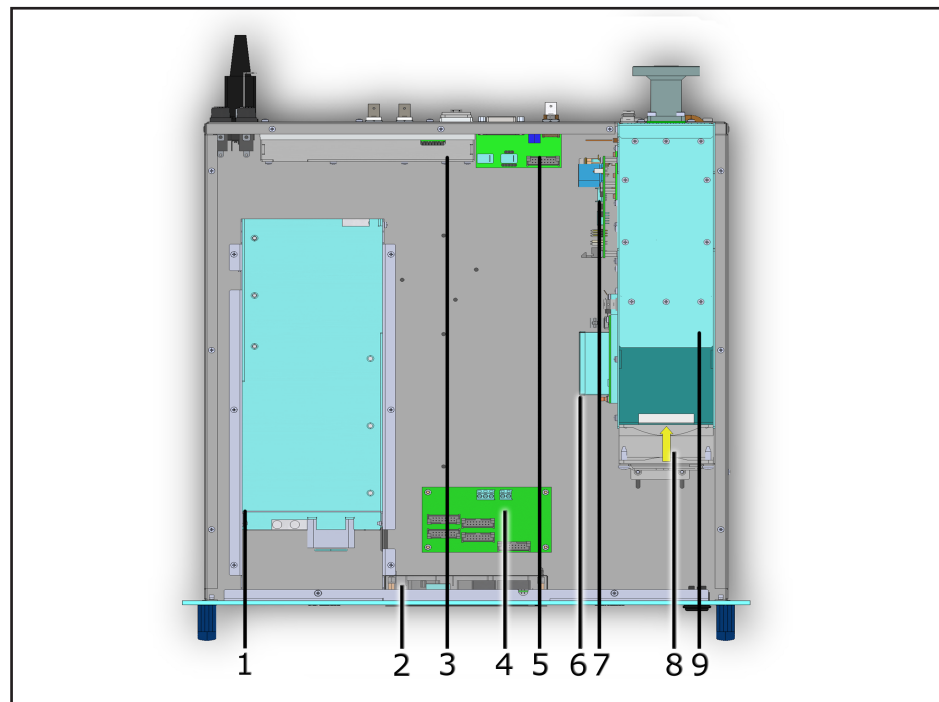

figure 8.1

- [1] Power Supply Block
- [2] Panel Lock
- [3] Motherboard & Stereo Coder Board
- [4] Power Supply and Fan Interface Board
- [5] Telemetry Board
- [6] Driver Board
- [7] Bias Board
- [8] Fan
- [9] Power Amplifier Block (contains Low Pass Filter Board, Directional Coupler board)

7. Principles of Operation

There is a schematic view of the modules and connections that make up the **TEX1002TFT** in figure 7.1.

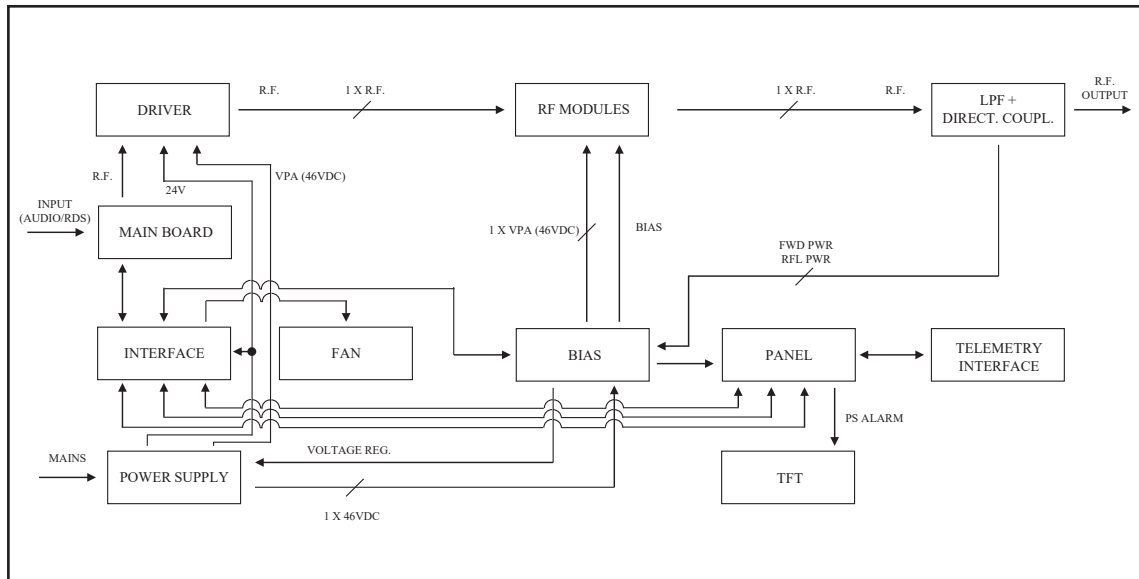

Figure 7.1

A brief description of the functions of each module is given below, and the complete diagrams and layouts of the boards can be found in the “Technical Appendix” Vol.2.

7.1 Panel board

The panel board contains the microcontroller that implements the control and management software of the device, the display and the other elements needed to interface with the user.

The board interfaces with the other modules of the device, providing for the distribution of power supplies, control signals and measurements.

7.2 Motherboard

The main board performs the following functions:

- Processing of audio, MPX and SCA inputs;
- Selection of input impedance
- 15 kHz filtering of the R and L channels
- Preemphasis

- Stereophonic coding
- Mixing of mono, MPX and SCA channels
- Clipper (limits the level of the modulating signal so that the frequency deviation does not exceed 75kHz)
- Generation of the carrier of the modulated radiofrequency signal;
- Measurement of the modulating signal

7.3 Telemetry Board

This device is designed to provide the operating status of the equipment. All the main input and output signals of the equipment are reported on the DB15 connector.

On the same card there is also the “INTERLOCK” BNC connector to disable the device. By closing the centre pin to ground, the output power is reduced to zero until the connection is removed.

When used with an RVR amplifier, this connector is connected via a BNC-BNC connector to the REMOTE or INTERLOCK of the power amplifier. In case of amplifier faults, the central conductor is grounded forcing the equipment to enter stand-by mode.

7.4 Power Supply Block

The **TEX1002TFT** power supply provides the two main power supplies:

1. **Services.** This voltage powers elements that do not directly affect the power supply such as the motherboard, panel board and fans.
2. **Power supply.** This voltage powers the RF power amplifier module and protects the equipment from any sudden fluctuations in the mains voltage.

7.5 Power Amplifier Block

The final power stage is enclosed in a totally shielded metal container fixed in the central part of the equipment.

The RF signal coming from the input power connectors is sent to the final stage which provides the last amplification up to 1000W (for the **TEX1002TFT** model).

The amplification stage consists of two main blocks:

- Amplification stage;
- Low-pass filter, which also includes the power meter.

In this block there is an RF pickup at approximately -46dB (for the **TEX1002TFT** model) with respect to the output available on a BNC connector below the transmitter output connector. This pickup is used to assess the characteristics of the carrier, but not those of the upper harmonics.

7.6 Bias Board

The main functions of this board are:

- Control of the output power level according to the setting
- Reduction of the power delivered in the presence of high levels of reflected power
- Measurement of the current absorbed by the power amplifier
- Temperature measurement

In the absence of alarm conditions, the voltage is regulated only according to the set output power controlled by the automatic levelling control (ALC).

Voltage is also affected by other factors, i.e.:

- Excess of reflected power.
- External AGC signals (Ext. AGC FWD, Ext. AGC RFL).
- Over-temperature.
- Excess current drawn by the RF module.

7.7 Driver Board

Before passing to the final power amplifier, the RF signal is pre-amplified in this section and when the transmitter is put on standby, the driver is also inhibited.

8. Maintenance and Repair Procedures

8.1 Introduction

This section gives general information on maintenance and electrical adjustments for the **TEX1002TFT** exciter.

Maintenance is divided into two sections depending on the complexity of the procedure and the test equipment required to complete the maintenance.

8.2 Safety Considerations

When the amplifier is operational, dangerous voltages, high currents, and strong RF signals are present inside.



CAUTION: Do not remove any covers without first turning off the device and make sure you have closed them all before restarting the device. Be sure to disconnect the amplifier from the mains before proceeding with any maintenance on the system.

8.3 Ordinary maintenance

The only regular maintenance required for the **TEX1002TFT** is periodic replacement of the fans and cleaning to remove dust in the air filter and any traces inside the amplifier.

The frequency of these operations depends on the operating conditions of the device: ambient temperature, level of dust in the air, humidity, etc...

It is advisable to carry out a preventive check every 6 months, and to replace the fans that make abnormal noises.

The fans should be replaced in case of problems as soon as possible and in any case at least every 24 months.

8.3.1 Replacing malfunctioning fans

- Open the top cover of the **TEX1002TFT** by unscrewing all the screws.
- Identify the fan to be replaced.

- Unscrew all points **A** using an Allen key.

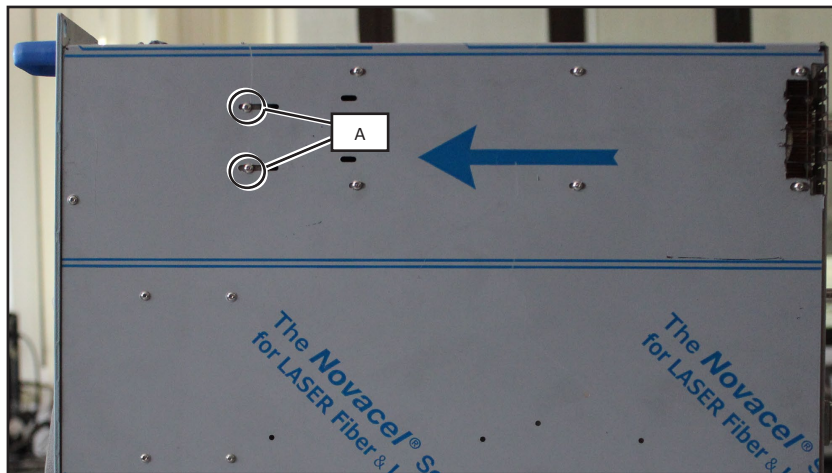

- Unscrew all points **B** from the side using an Allen key.

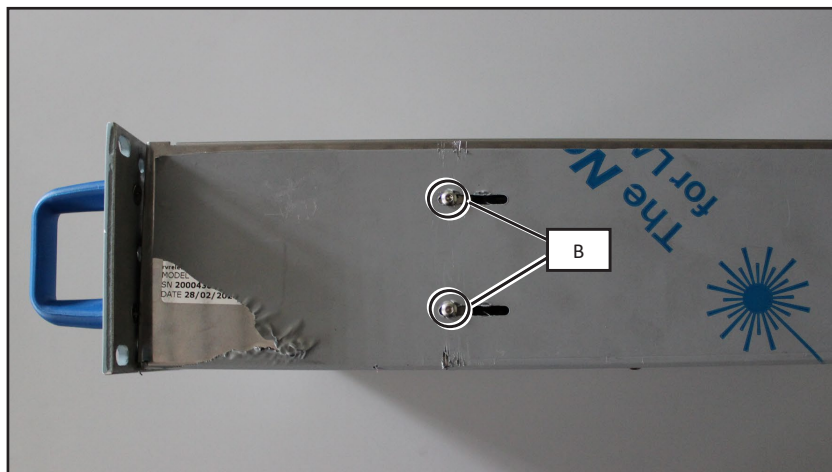

- Unscrew all points **C** using a flat head screwdriver.

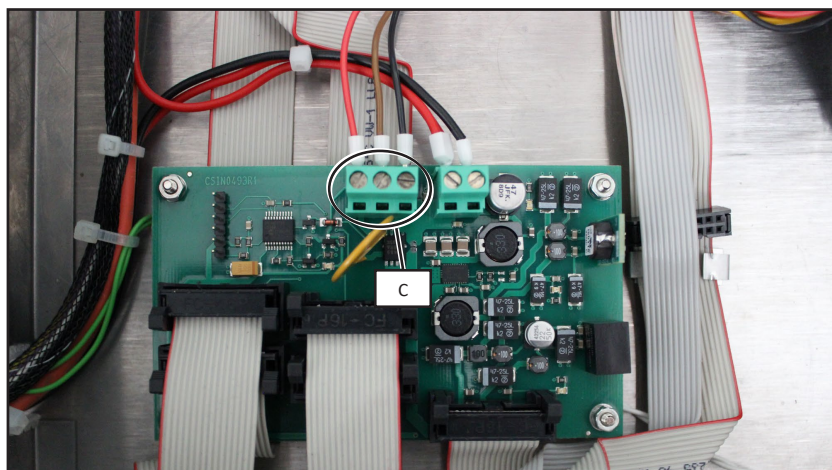

- Remove the malfunctioning fan at points **D**.

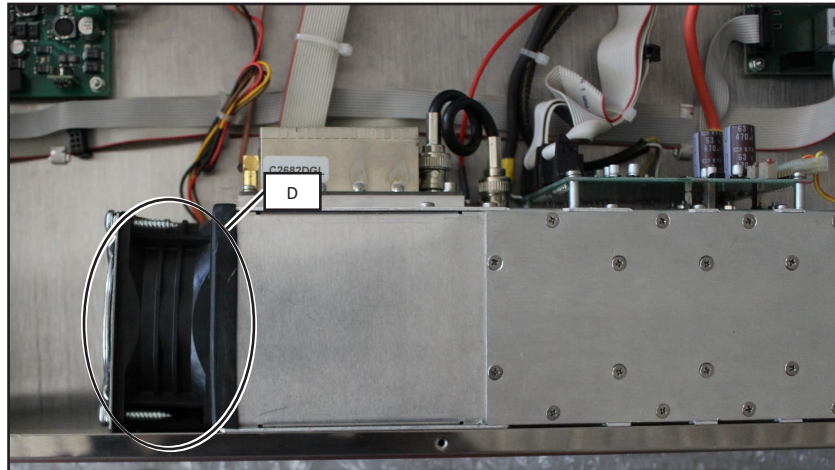

- Insert the new fan (mod. **9GV0824P1G03 Sanyo Denki**).
- Repeat the procedure above in reverse order to reassemble and fix the fan in its seat.
- Put the cover back and tighten all the screws needed to close it.

8.3.1 Replacing the deteriorated filter

- Unscrew the six screws **A** of the **TEX1002TFT** front panel.

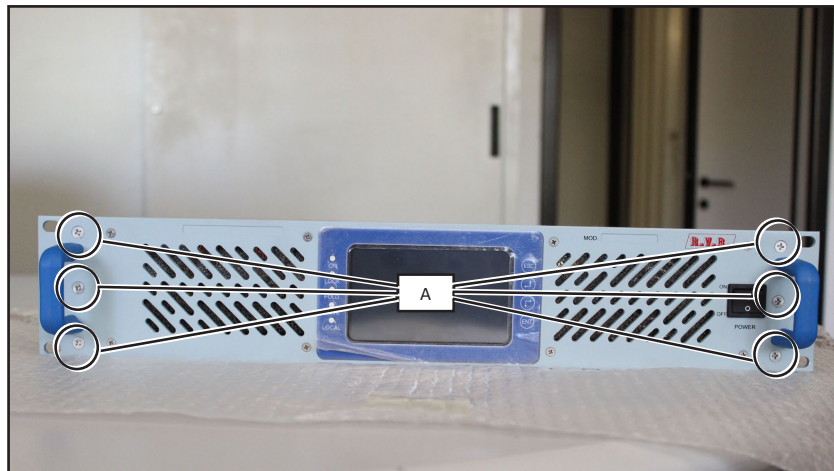

- Unscrew all points **B** using an Allen key.

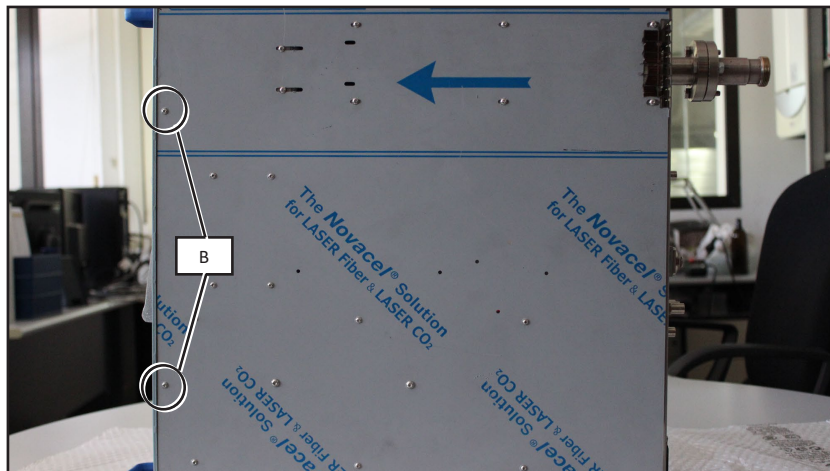

- Unscrew the screws **C** and **D** of the **TEX1002TFT** front panel, if you want to replace or wash both filters. If you want to replace or wash only one of the filters, unscrew only the point of interest.

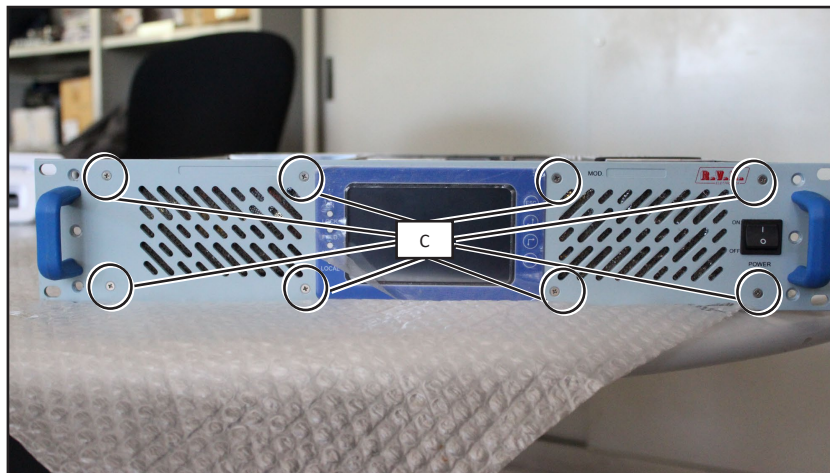

- Remove filters **D** and **E** and insert the new spare part (mod. **PMFILAIR241A**), if you want to replace both filters. If you only want to replace one of the filters, just remove the point of interest.

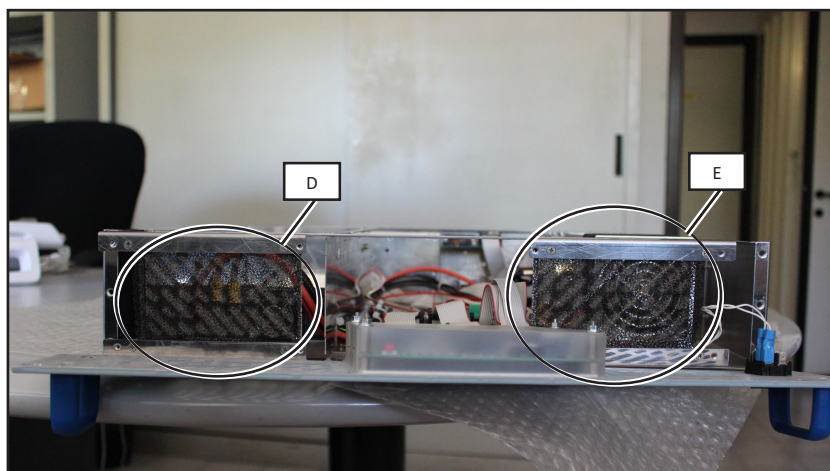

- The filter can also be easily washed by hand with just cold water, after removing the worst of the dust by hand, rather than replacing it.



- Repeat the procedure above in reverse order to reassemble and fix the filter in its seat.
- Put the cover back and tighten all the screws needed to close it.

8.4 Replacing the Modules

Arrange for authorized and qualified technical personnel to replace the component parts in the device.

8.4.1 Replacing the power supply

When the amplifier is operational, dangerous voltages, high currents, and strong RF signals are present inside.

- Open the top cover of the **TEX1002TFT** by unscrewing all the screws.
- Identify the power supply module to be replaced.
- Unscrew all points **A** using an Allen key.

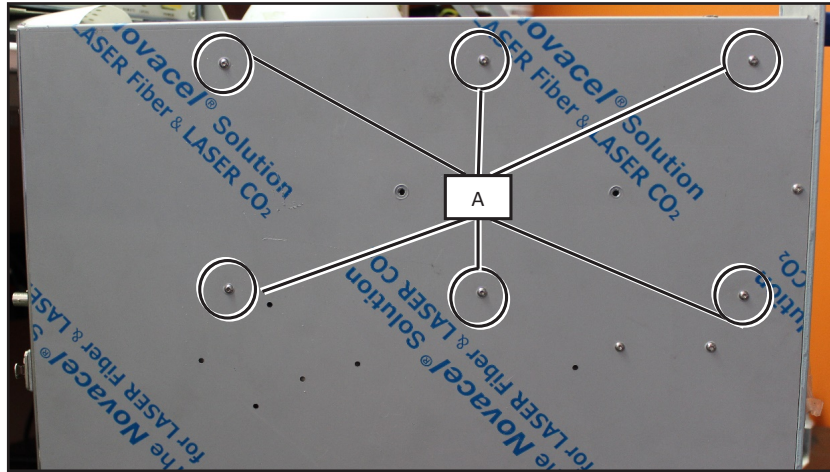

- Place the module on one side and unscrew all points **B** from the side using an Allen key.

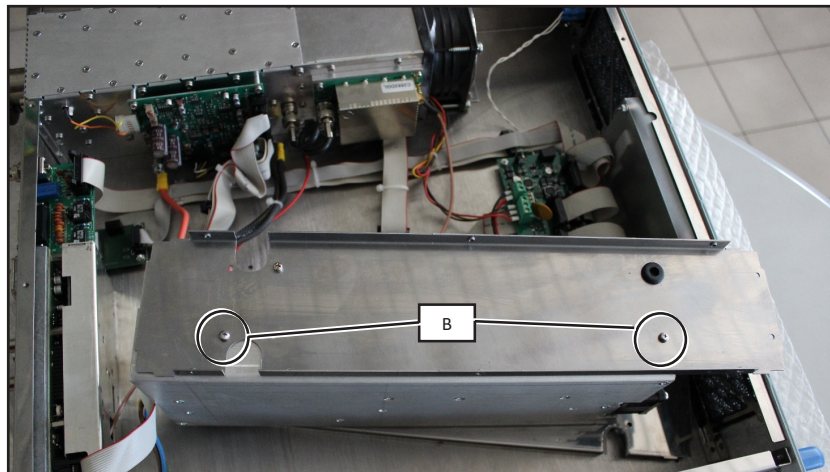

- Place the module on the other side and unscrew all points **C** from the side using an Allen key.

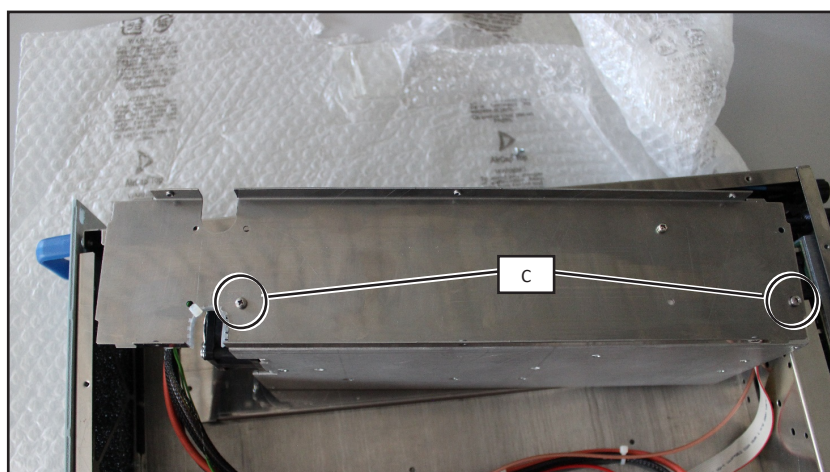

- Remove the metal plate **D**.

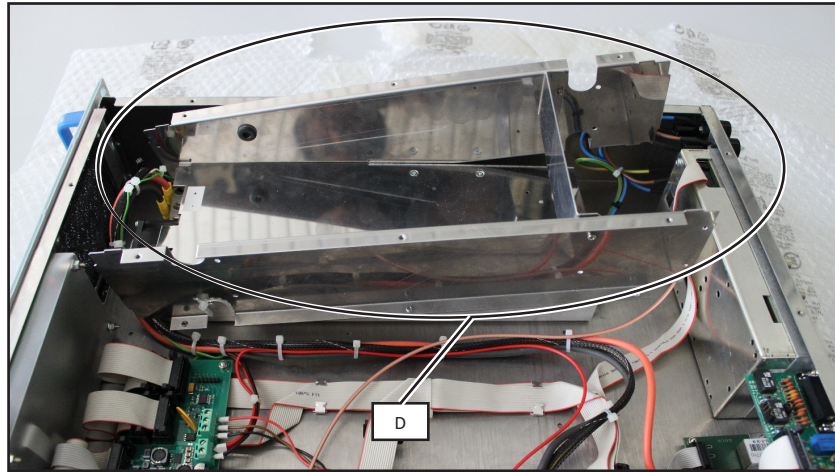

- Unscrew all points **E** using a Phillips screwdriver. Then disconnect the power cables.

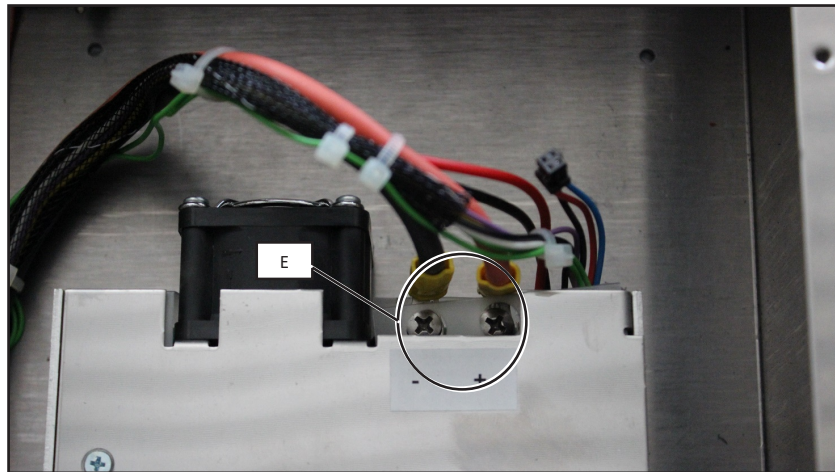

- Disconnect all connectors at points **F**.

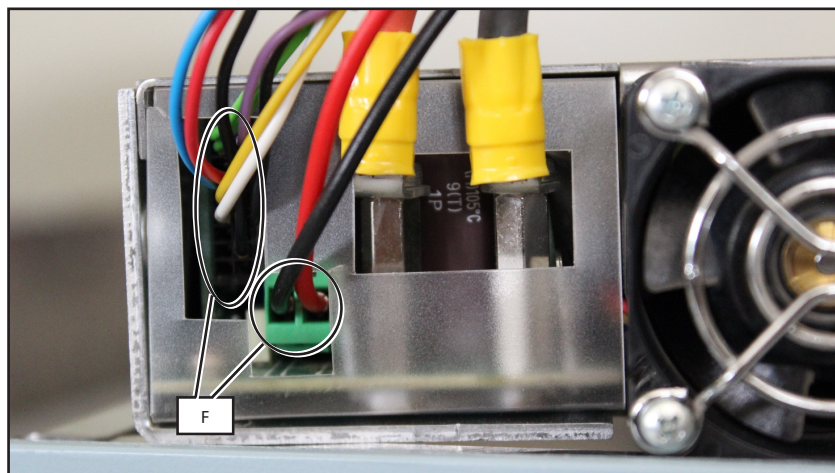

- Unscrew all the **G** points using a flat head screwdriver.



- Remove the power supply module and replace it with the new power supply.
- Repeat the procedure above in reverse order to reassemble and fix the module in its seat.
- Put the cover back and tighten all the screws needed to close it.

8.4.2 Replacing the RF module

- Open the top cover of the **TEX1002TFT** by unscrewing all the screws.
- Identify the RF module to be replaced.
- Unscrew all points **A** from the side using an Allen key.

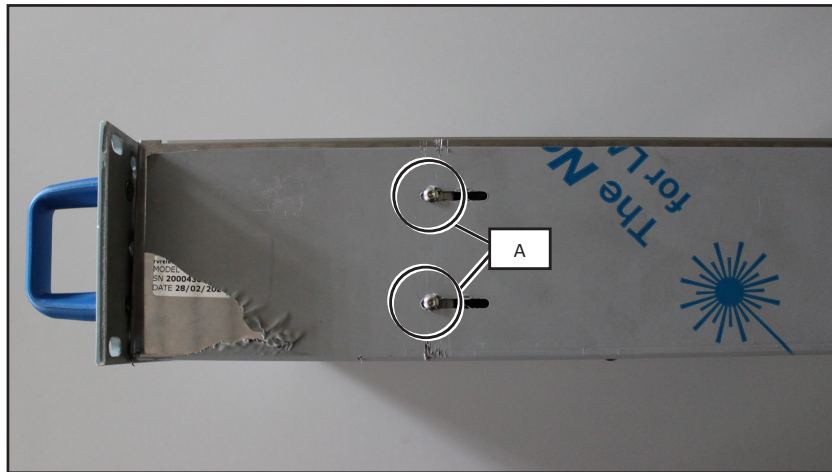

- Unscrew all points **B** using an Allen key.

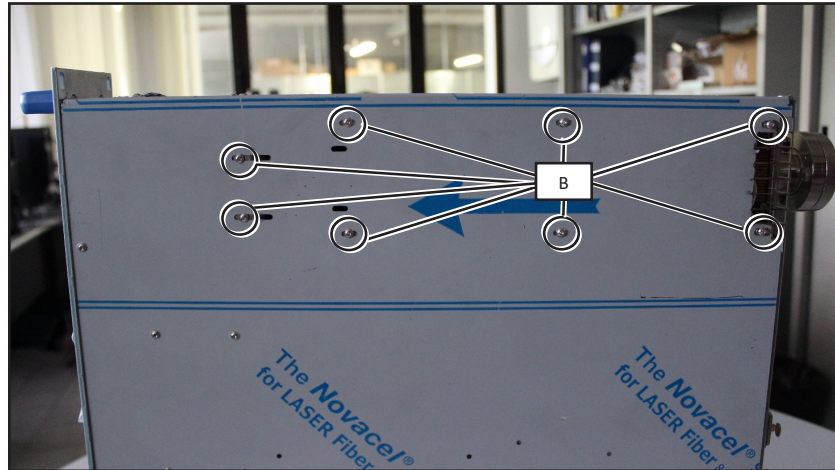

- Unscrew all points **C** using an Allen key.

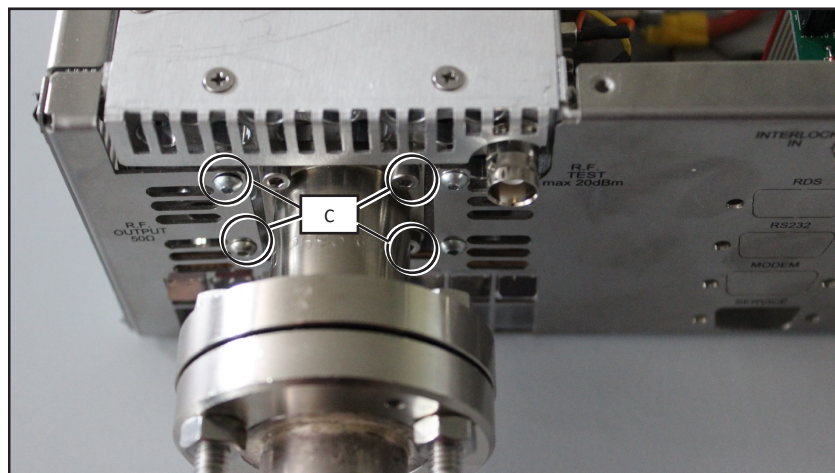

- Move the fan of point **D**.

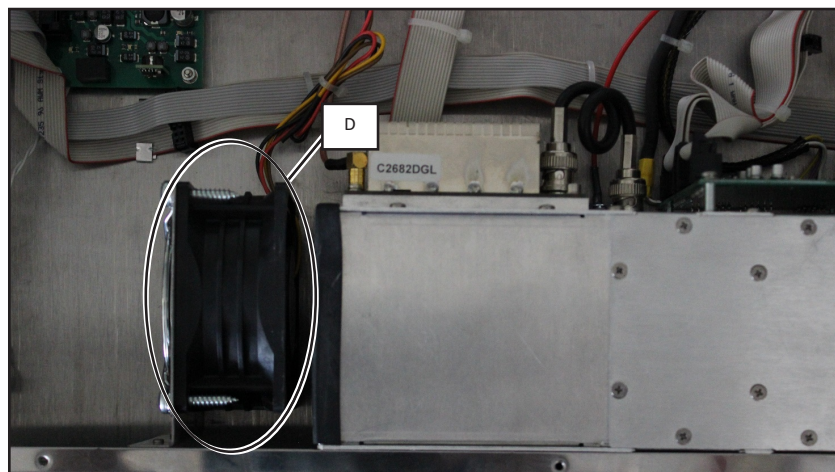

- Move the module of point **E**.

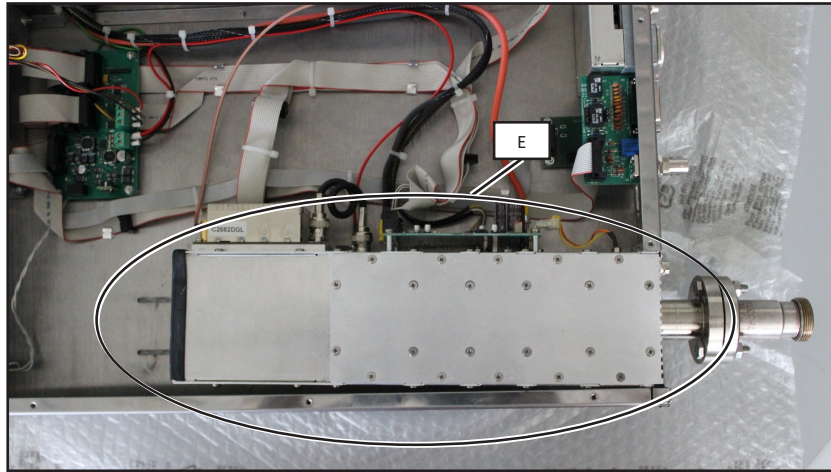

- Unscrew the connectors **F** and disconnect the connectors **G**.

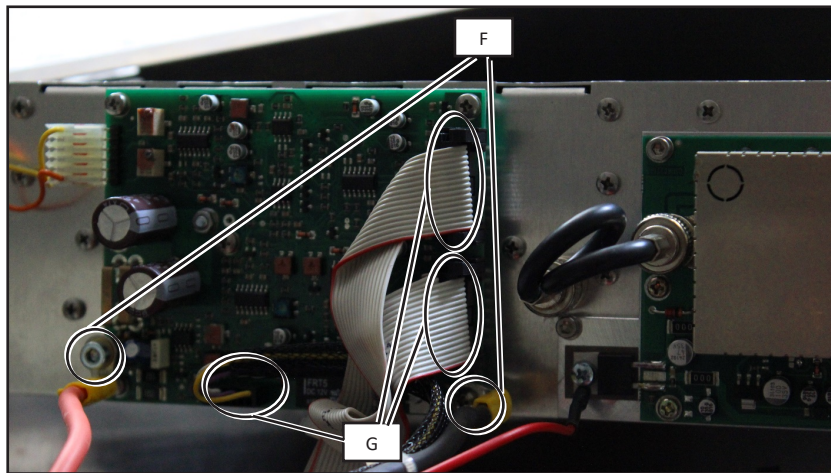

- Disconnect the connectors **H** and unscrew points **I** and **J**.

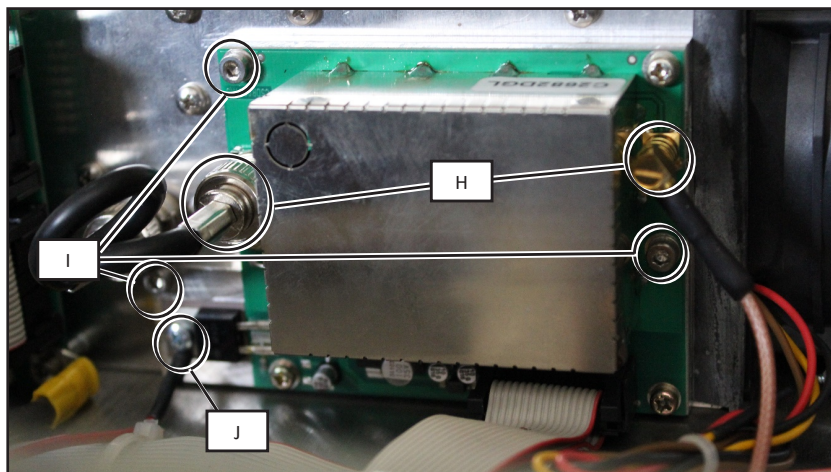

- Remove the driver board.
- Remove the RF module and replace it with the new module.
- Repeat the procedure above in reverse order to reassemble and fix the module in its seat.

- Put the cover back and tighten all the screws needed to close it.

8.4.3 Replacing the motherboard

- Open the top cover of the **TEX1002TFT** by unscrewing all the screws.
- Identify the module to be replaced.
- Unscrew the screw **A** of the cover box of the motherboard.

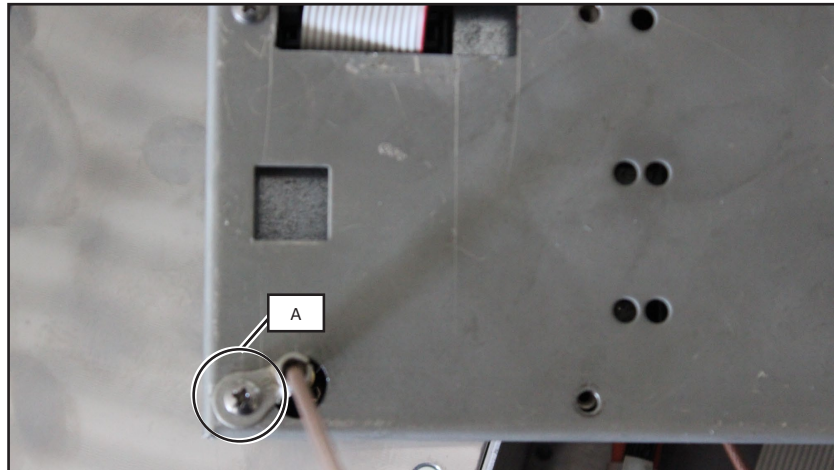

- Disconnect the connector **C** and unscrew the RF connector **D**.

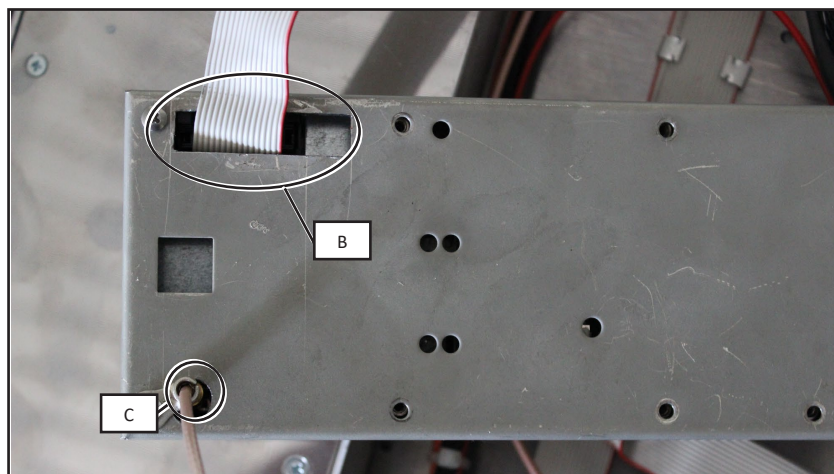

- Remove the motherboard and replace it with the new module.
- Repeat the procedure above in reverse order to reassemble and fix the module in its seat.
- Put the cover back and tighten all the screws needed to close it.

8.4.4 Replacing the panel board

- Unscrew the six screws **A** of the **TEX1002TFT** front panel.

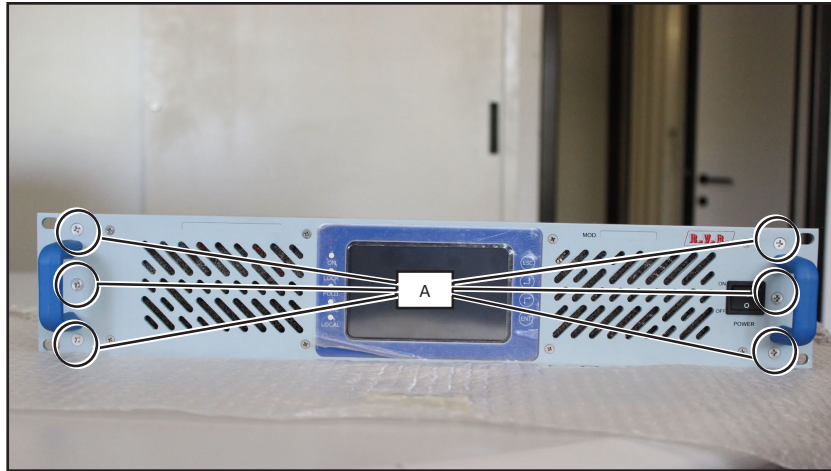

- Unscrew all points **B** using an Allen key.

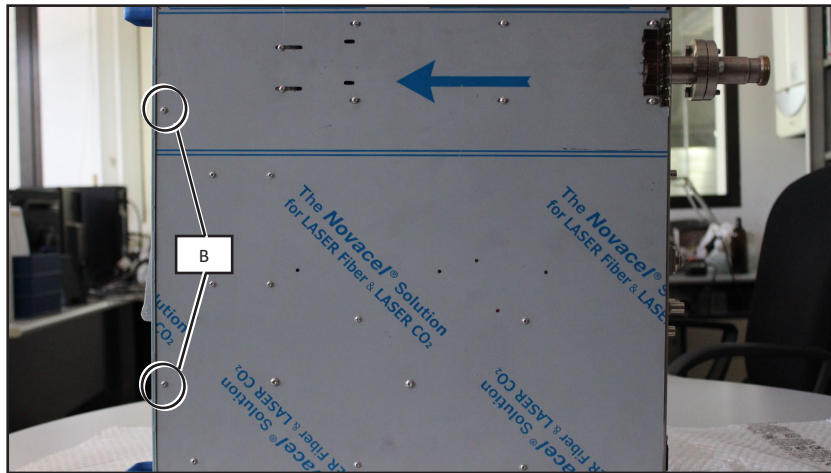

- Remove panel **C**.

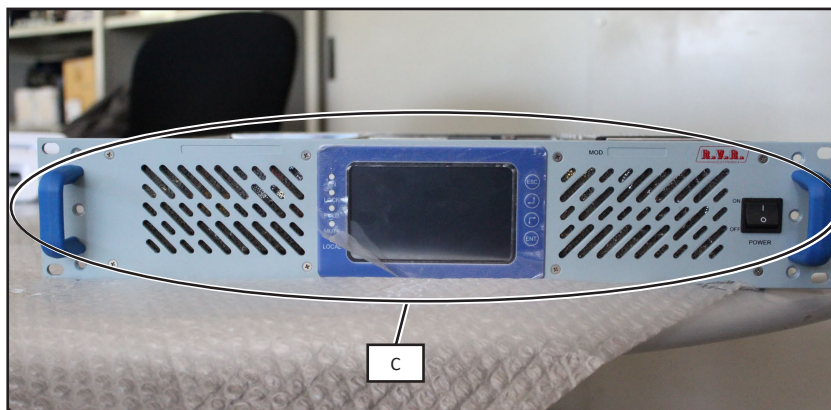

- Unscrew all points **D** using a socket screwdriver, and then lift the protective plastic cover.

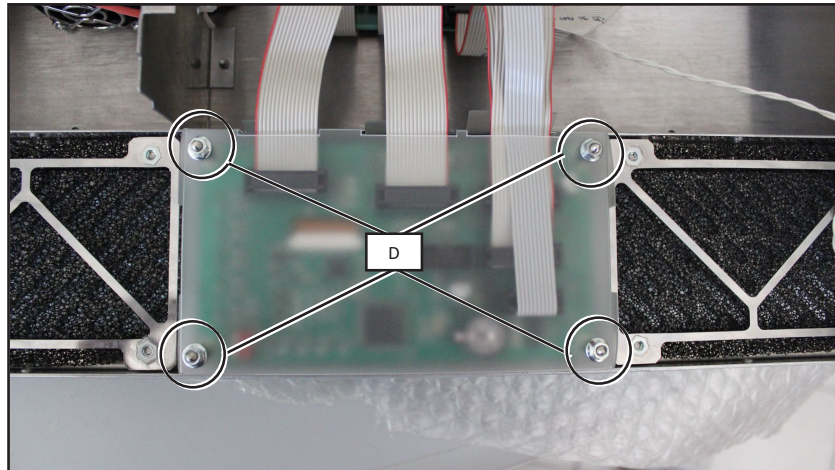

- Disconnect the connectors **E**.

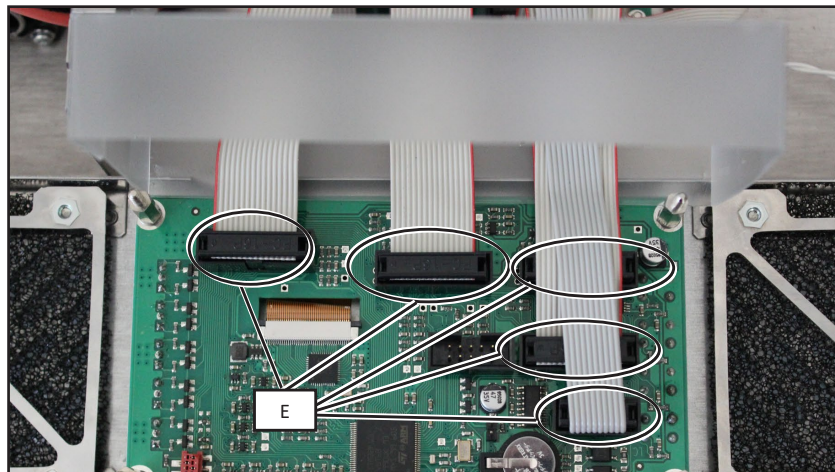

- Unscrew all points **F** internally using a screwdriver.

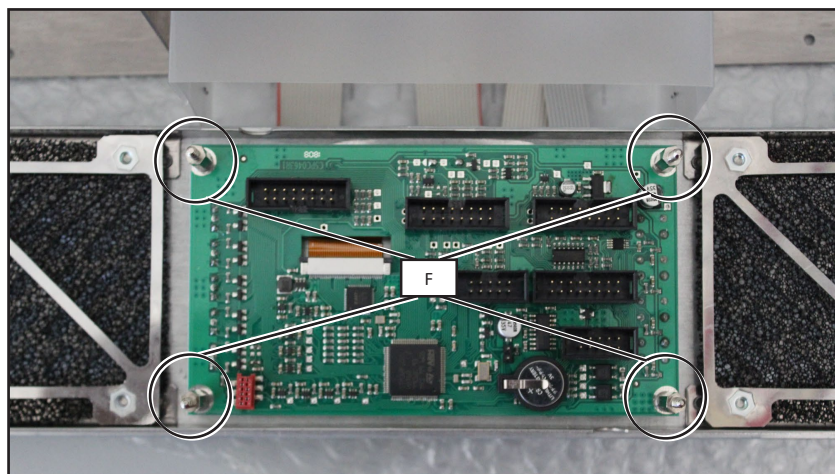

- Disconnect the connector **G**, being very careful to unlock the two side locks before proceeding with the operation.

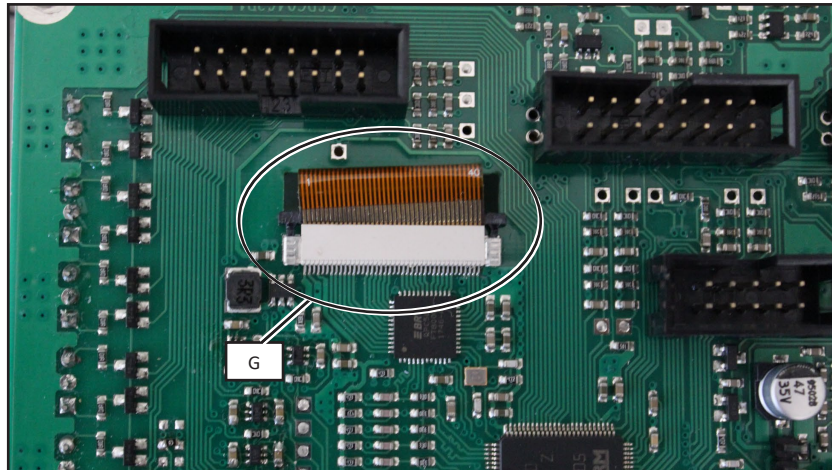

- Remove the panel lock and replace it with the new module.
- Repeat the procedure above in reverse order to reassemble and fix the module in its seat.
- Put the cover back and tighten all the screws needed to close it.

8.4.5 Replacing the power supply interface board

- Open the top cover of the **TEX1002TFT** by unscrewing all the screws.
- Identify the module to be replaced.
- Unscrew all points **A** using a Phillips screwdriver.

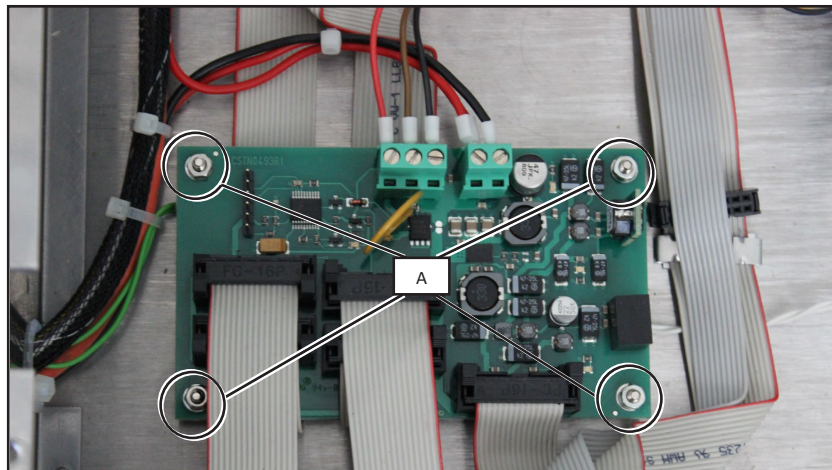

- Disconnect the connectors **B** and unscrew points **C**.

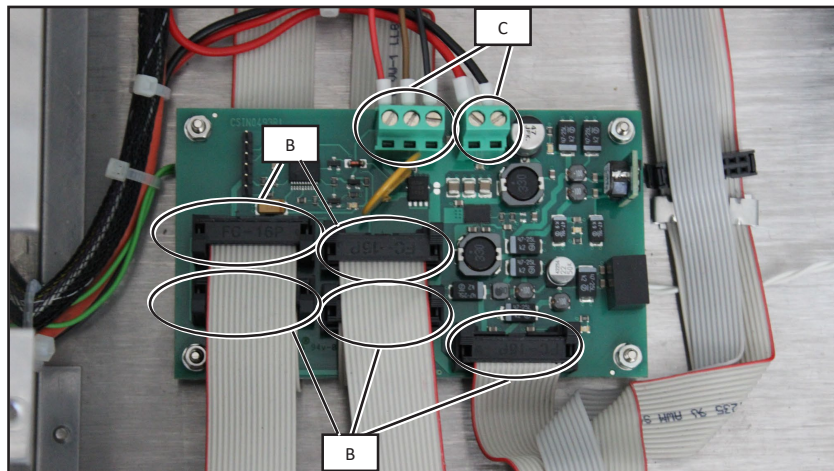

- Remove the board and replace it with the new module.
- Repeat the procedure above in reverse order to reassemble and fix the module in its seat.
- Put the cover back and tighten all the screws needed to close it.

8.4.6 Replacing the driver board

- Open the top cover of the **TEX1002TFT** by unscrewing all the screws.
- Identify the module to be replaced.
- Disconnect the connectors **A** and unscrew points **B** and **C**.

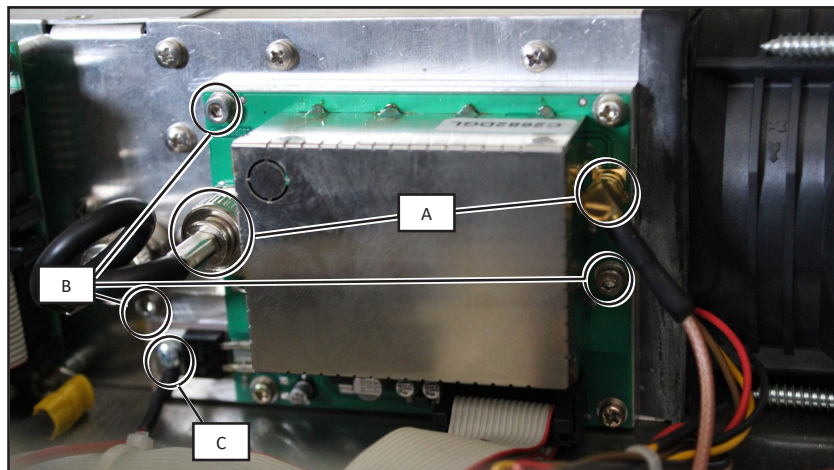

- Remove the driver board and replace it with the new board.
- Repeat the procedure above in reverse order to reassemble and fix the module in its seat.
- Put the cover back and tighten all the screws needed to close it.

8.4.7 Replacing the telemetry card

- Open the top cover of the **TEX1002TFT** by unscrewing all the screws.
- Identify the module to be replaced.
- Unscrew the hex washer **A** and the two threaded hex spacers **B** of the rear panel of the **TEX1002TFT**.

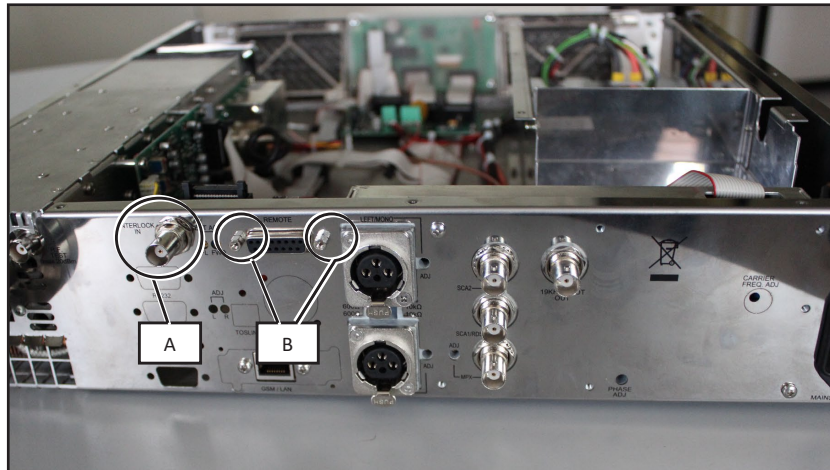

- Disconnect the connector **C**.

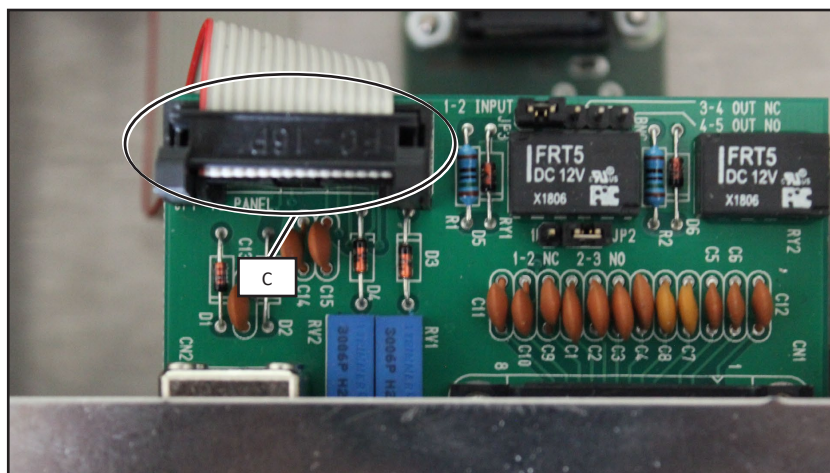

- Remove the board and replace it with the new module.
- Repeat the procedure above in reverse order to reassemble and fix the module in its seat.
- Put the cover back and tighten all the screws needed to close it.

9. Options

This section shows views on the variants with respect to the basic version to be requested when ordering.

For more information about the options, refer to the respective instruction manuals.

9.1 Option /AUDIGIN-TFT

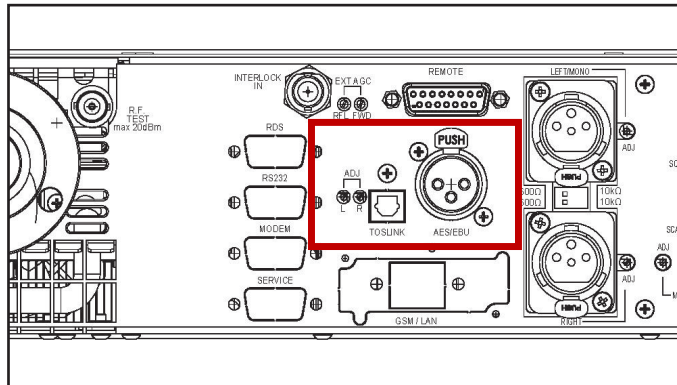

Digital Input

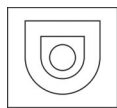

Tipo: TOS-LINK Femmina

Left (MONO) / Right

Tipo: Femmina XLR



- 1 GND
- 2 Positivo
- 3 Negativo

9.2 Option /RDS-TEX-E-2HE

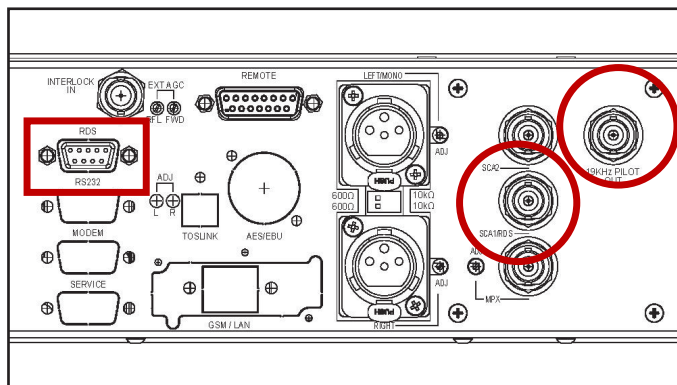

Service/RDS

Tipo: Femmina DB9

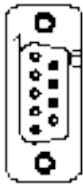

- 1 GND
- 2 RS232 TX
- 3 RS232 RX
- 4 NC
- 5 GND
- 6 NC
- 7 NC
- 8 RDS CARRIER OUT
- 9 PILOT IN

9.3 Option /TLW-TFT-E-2HE

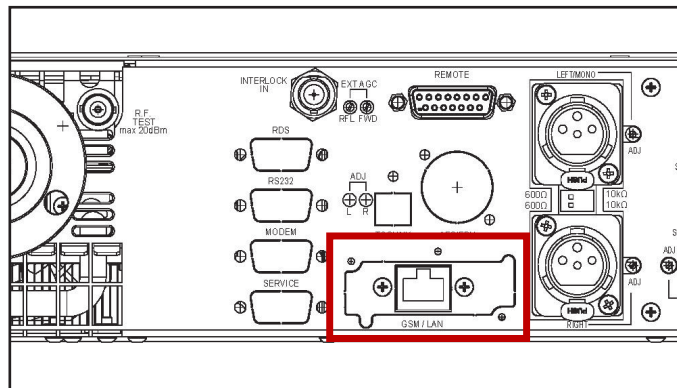

Ethernet

Tipo: femmina RJ45

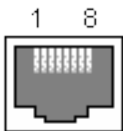

- 1 TX+
- 2 TX-
- 3 RX+
- 4 NC
- 5 NC
- 6 RX-
- 7 NC
- 8 NC





R.V.R. Elettronica S.r.l.
Via del Fonditore 2 / 2c
40138 · Bologna · Italy
Phone: +39 051 6010506 · Fax: +39 051 6011104
e-mail: info@rvr.it · web: <http://www.rvr.it>

Member of CISQ Federation



The RVR Logo, and other RVR referenced products and services are trademarks of RVR Elettronica in Italy, other countries or both. RVR © 1998 all rights reserved.
All other trademarks, trade names or logos used are the property of their respective owners.