

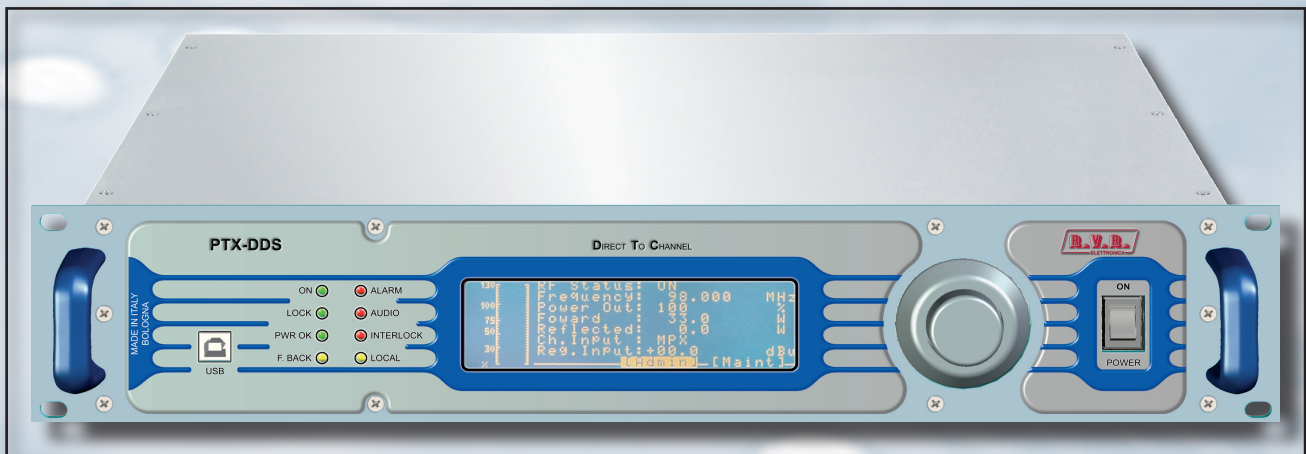

PTX30DDS PTX100DDS & PTX150DDS

USER MANUAL
VOLUME1



File Name: PTX-DDS_ING_2.1.indb

Version: 2.1

Date: 24/07/2018

Document History

Date	Version	Reason	Editor
05/02/2016	2.0	First Version	J. H. Berti
24/07/2018	2.1	Major upgrade and TRDSP descripton	J. H. Berti

PTX-DDS - User Manual
Version 2.0

© Copyright 2016 - 2018

R.V.R. Elettronica

Via del Fonditore 2/2c - 40138 - Bologna (Italia)

Telefono: +39 051 6010506

Fax: +39 051 6011104

Email: info@rvr.it

Web: www.rvr.it

All rights reserved

Printed and bound in Italy. No part of this manual may be reproduced, memorized or transmitted in any form or by any means, electronic or mechanic, including photocopying, recording or by any information storage and retrieval system, without written permission of the copyright owner.

Notification of intended purpose and limitations of product use

This product is a FM transmitter intended for FM audio broadcasting. It utilizes operating frequencies not harmonised in the intended countries of use. The user must obtain a license before using the product in intended country of use. Ensure respective country licensing requirements are complied with. Limitations of use can apply in respect of operating frequency, transmitter power and/or channel spacing.

Declaration of Conformity

Hereby, R.V.R. Elettronica, declares that this FM transmitter is in compliance with the essential requirements and other relevant provisions of Directive 2014/53/EU.



Technical Description

Parameters	Conditions	U.M.	PTX30-DDS
GENERALS			
Frequency range		MHz	87.5 + 108
Frequency programmability			From software, with 1 kHz steps
Rated output power		W	30
Modulation type			Direct Digital Synthesis
Operational Mode			Mono, Stereo, Multiplex
Ambient working temperature		°C	0 to + 50 (operational -10)
Frequency stability	WT from -10°C to 50°C	ppm	±1
Modulation capability		kHz	150
Pre-emphasis mode		µS	0, 50 (CCIR), 75 (FCC)
Spurious & harmonic suppression	Referred to 100% AM, with no de-emphasis	dBc	> 80 (85 typical)
Asynchronous AM S/N ratio	Referred to 100% AM, FM deviation 75 kHz by 400Hz sine, without de-emphasis	dB	≥ 60
Synchronous AM S/N ratio		dB	≥ 50
MONO OPERATION			
S/N FM Ratio	RMS @ ± 75 kHz peak, HPF 20Hz - LPF 23 kHz, 50 µS de-emphasis demodulated	dB	> 85 (typical 90)
	Qpk @ ± 75 kHz peak, CCIR weighted, 50 µS de-emphasis	dB	> 84
	Qpk @ ± 40 kHz peak, CCIR weighted, 50 µS de-emphasis	dB	> 78
Frequency Response	30Hz - 15kHz	dB	better than ± 0.5 dB (typical ± 0.2)
Total Harmonic Distortion	THD+N 30Hz - 15kHz	%	< 0.05 (Typical 0.03%)
Intermodulation Distortion	Measured with a 1 KHz and 1.3 KHz tones, 1:1 ratio, at FM 75 kHz	%	< 0.02
Transient intermodulation distortion	Measured with a 3.18 kHz square wave and a 15 kHz sine wave at 75 kHz FM	%	< 0.1 (typical 0.05)
MPX OPERATION			
Composite S/N FM Ratio	RMS @ ± 75 kHz peak, HPF 20Hz - no LPF, 50 µS de-emphasis demodulated	dB	> 75 (typical 79)
	Qpk @ ± 75 kHz peak, CCIR weighted, 50 µS de-emphasis	dB	> 70 (typical 72)
	Qpk @ ± 40 kHz peak, CCIR weighted, 50 µS de-emphasis	dB	> 67 (typical 69)
Frequency Response	30Hz - 53kHz	dB	± 0.2
	53kHz - 100kHz	dB	± 0.5
Total Harmonic Distortion	THD+N 30Hz + 53kHz	%	< 0.05
	THD+N 53kHz + 100kHz	%	< 0.1
Intermodulation distortion	Measured with a 1 KHz and 1.3 KHz tones, 1:1, modulation at FM 75 kHz	%	< 0.05
Transient intermodulation distortion	Measured with a 3.18 kHz square wave and a 15 kHz sine wave at 75 kHz FM	%	< 0.1 (typical 0.05)
Stereo separation	400Hz + 5kHz	dB	> 70
	40Hz + 15kHz	dB	> 60
STEREO OPERATION			
Stereo S/N FM Ratio	RMS @ ± 75 kHz peak, HPF 20Hz - LPF 23 kHz, 50 µS de-emphasis, L & R demodulated	dB	> 80 (Typical 83)
	Qpk @ ± 75 kHz peak, CCIR weighted, 50 µS de-emphasis, L & R demodulated	dB	> 70 (Typical 73)
	Qpk @ ± 40 kHz peak, CCIR weighted, 50 µS de-emphasis, L & R demodulated	dB	> 67 (Typical 70)
Frequency Response	30Hz - 15kHz	dB	± 0.5
Total Harmonic Distortion	THD+N 30Hz - 15kHz	%	< 0.05
Intermodulation distortion	Measured with 1 KHz and 1.3 KHz tones, 1:1 ratio, modulation at FM 75 kHz	%	≤ 0.03
Transient intermodulation distortion	Measured with a 3.18 kHz square wave and a 15 kHz sine wave at 75 kHz FM	%	< 0.1 (typical 0.05)
Stereo separation	400Hz = 5kHz	dB	> 70
	40Hz + 15kHz	dB	> 60
Main / Sub Ratio	30Hz - 15kHz	dB	> 40 (typical 45)
SCA OPERATION			
Frequency response	40kHz - 100kHz	dB	± 0.5
AUDIO INPUTS			
Analog Left / MPX balanced	Connector		XLR F
	Type		balanced or externally unbalanced
	Impedance	Ohm	10 k or 600
	Input Level, Adjustment Range	dBu	-12.5 to +12.5
Analog Right balanced	Connector		XLR F
	Type		balanced or externally unbalanced
	Impedance	Ohm	10 k or 600
	Input Level, Adjustment Range	dBu	-12.5 to +12.5
Analog MPX unbalanced	Connector		BNC
	Type		unbalanced
	Impedance	Ohm	10 k
	Input Level, Adjustment Range	dBu	-12.5 to +12.5
Digital AES/EBU	Connector		XLR, AES/EBU 24-96 KHz
	Type		balanced
	Impedance	Ohm	75 or 110
	Input Level, Adjustment Range	Vpp	+3 to +10
Digital SPDIF Optical	Connector		TosLink F05 - EIAJ
	Connector		Cinch- RCA coaxial
Digital SPDIF Electrical	Connector		
	Type		
	Impedance	Ohm	75
	Input Level, Adjustment Range	Vpp	+0.5 to +1
SCA/RDS	Connector		2 x BNC
	Type		unbalanced
	Impedance	Ohm	10 k
	Input Level, Adjustment Range	dBu	-12.5 to +12.5
OUTPUTS			
RF Output	Connector		N type
	Impedance	Ohm	50
	Connector		BNC
RF Monitor	Connector		BNC
	Impedance	Ohm	50
	Output Level	dB	approx. -30
Pilot output	Connector		BNC
	Impedance	Ohm	> 4,7 k
	Output Level	Vpp	1
MPX Monitor	Connector		BNC
	Impedance	Ohm	>600
	Output Level	dBu	0
AUXILIARY CONNECTIONS			
Interlock	Connector		BNC
RS232 Serial Interface	Connector		DB9 F
RS485 Serial Interface	Connector		
Remote Interface	Connector		DB15F
Input 1.0 MHz	Connector		BNC
POWER REQUIREMENTS			
AC Power Input	AC Supply Voltage	VAC	115 / 230 ±15%
	AC Apparent Power Consumption	kVA	0.14
	Active Power Consumption	kW	0.07
	Power Factor		0.51
	Connector		
FUSES			
On PA Supply			1 External fuse 6,3 AT - 5x20 mm
MECHANICAL DIMENSIONS			
Physical Dimensions	Front panel width	mm	483 (19")
	Front panel height	mm	88 (3 1/2")
	Overall depth	mm	400 (15,7")
Weight		kg	13
OPTIONS			
Input 1.0 MHz		code	
GPS		code	
TELEMETRY-TELECONTROL SW			
Telecon			Yes
VARIOUS			
Cooling			Forced, with internal fan
Acoustic Noise		dBA	< 56
STANDARD COMPLIANCE			
Safety			EN 60215:1989
			EN 60215/A1:1992-07
			EN 60215/A2:1994-09
EMC			ETSI EN 301 489-11 V1.2.1
			ETSI EN 301 489-11 V1.4.1
			ETSI EN 302 018-1 V1.1.1
			ETSI EN 302 018-2 V1.1.1
Spectrum Optimization			

Table of Contents

1.	Preliminary Instructions	1
2.	Warranty	1
3.	First Aid	2
3.1	Treatment of electrical shocks	2
3.2	Treatment of electrical Burns	2
4.	General Description	3
4.1	Unpacking	3
4.2	Features	3
4.3	Frontal Panel Description	5
4.4	Rear Panel Description	6
4.5	Connector Pinouts	7
5.	Quick guide for installation and use	9
5.1	Using the encoder	9
5.2	Preparation	10
5.3	First power-on and setup	10
6.	Operating System	16
6.1	Start-up	16
6.2	Operating System	16
6.3	Menu Organization	18
6.4	Set up Reset	45
6.5	Audio Rescuer	46
6.6	I.T.U.	49
6.7	A.G.C. and Clipper	50
7.	Modules Identification	51
7.1	Top View	51
7.2	Power supply unit	52
7.3	Power amplifier	52
7.4	Panel Card	53
7.5	16-bit CPU Card	53
7.6	FM modulator Card	53
7.7	TRDSP Card	54

This page was intentionally left blank

IMPORTANT



The symbol of lightning inside a triangle placed on the product, evidences the operations for which is necessary gave it full attention to avoid risk of electric shocks.



The symbol of exclamation mark inside a triangle placed on the product, informs the user about the presence of instructions inside the manual that accompanies the equipment, important for the efficacy and the maintenance (repairs).

1. Preliminary Instructions

• General Warnings

This equipment should only be operated, installed and maintained by “trained” or “qualified” personnel who are familiar with risks involved in working on electric and electronic circuits. “Trained” means personnel who have technical knowledge of equipment operation and who are responsible for their own safety and that of other unqualified personnel placed under their supervision when working on the equipment.

“Qualified” means personnel who are trained in and experienced with equipment operation and who are responsible for their own safety and that of other unqualified personnel placed under their supervision when working on the equipment.

 **WARNING: Residual voltage may be present inside the equipment even when the ON/OFF switch is set to Off. Before servicing the equipment, disconnect the power cord or switch off the main power panel and make sure the safety earth connection is connected. Some service situations may require inspecting the equipment with live circuits. Only trained and qualified personnel may work on the equipment live and shall be assisted by a trained person who shall keep ready to disconnect power supply at need.**

R.V.R. Elettronica shall not be liable for injury to persons or damage to property resulting from improper use or operation by trained/untrained and qualified/unqualified persons.

 **WARNING: The equipment is not water resistant. Any water entering the enclosure might impair proper operation. To prevent the risk of electrical shock or fire, do not expose this equipment to rain, dripping or moisture.**

Please observe local codes and fire prevention rules when installing and operating this equipment.

 **WARNING: This equipment contains exposed live parts involving an electrical shock hazard. Always disconnect power supply before removing any covers or other parts of the equipment.**

Ventilation slits and holes are provided to ensure reliable operation and prevent overheating; do not obstruct or cover these slits. Do not obstruct the ventilation slits under any circumstances. The product must not be incorporated in a rack unless adequate ventilation is provided or the manufacturer’s instructions are followed closely.

 **WARNING: This equipment can radiate radiofrequency energy and, if not installed in compliance with manual instructions and applicable regulations, may cause interference with radio communications.**

 **WARNING: This equipment is fitted with earth connections both in the power cord and for the chassis. Make sure both are properly connected.**

Operation of this equipment in a residential area may cause radio interference, in which case the user may be required to take adequate measures.

The specifications and data contained herein are provided for information only and are subject to changes without prior notice. **R.V.R. Elettronica** disclaims all warranties, express or implied. While R.V.R. Elettronica attempts to provide accurate information, it cannot accept responsibility or liability for any errors or inaccuracies in this manual, including the products and the software described herein. **R.V.R. Elettronica** reserves the right to make changes to equipment design and/or specifications and to this manual at any time without prior notice.

• Notice concerning product intended purpose and use limitations.

This product is a radio transmitter suitable for frequency-modulation audio radio broadcasting. Its operating frequencies are not harmonised in designated user countries. Before operating this equipment, user must obtain a licence to use radio spectrum from the competent authority in the designated user country. Operating frequency, transmitter power and other characteristics of the transmission system are subject to restrictions as specified in the licence.

2. Warranty

R.V.R. Elettronica warrants this product to be free from defects in workmanship and its proper operation subject to the limitations set forth in the supplied Terms and Conditions. Please read the Terms and Conditions carefully, as purchase of the product or acceptance of the order acknowledgement imply acceptance of the Terms and Conditions. For the latest updated terms and conditions, please visit our web site at WWW.RVR.IT. The web site may be modified, removed or updated for any reason whatsoever without prior notice. The warranty will become null and void in the event the product enclosure is opened, the product is physically damaged, is repaired by unauthorised persons or is used for purposes other than its intended use, as well as in the event of improper use, unauthorised changes or neglect. In the event a defect is found, follow this procedure:

- 1 Contact the seller or distributor who sold the equipment; provide a description of the problem or malfunction for the event a quick fix is available.

Sellers and Distributors can provide the necessary information to troubleshoot the most frequently encountered problems. Normally, Sellers and Distributors can offer a faster repair service than the Manufacturer would. Please note that Sellers can pinpoint problems due to wrong installation.

- 2 If your Seller cannot help you, contact **R.V.R. Elettronica** and describe the problem; if our staff deems it appropriate, you will receive an authorisation to return the equipment along with suitable instructions;
- 3 When you have received the authorisation, you may return the unit. Pack the unit carefully before shipment; use the original packaging whenever possible and seal the package perfectly. The customer bears all risks of loss (i.e., R.V.R. shall not be liable for loss or damage) until the package reaches the R.V.R. factory. For this reason, we recommend insuring the goods for their full value. Returns must be sent on a C.I.F. basis (PREPAID) to the address stated on the authorisation as specified by the R.V.R. Service Manager.



Units returned without a return authorisation may be rejected and sent back to the sender.

- 4 Be sure to include a detailed report mentioning all problems you have found and copy of your original invoice (to show when the warranty period began) with the shipment.

Please send spare and warranty replacement parts orders to the address provided below. Make sure to specify equipment model and serial number, as well as part description and quantity.



R.V.R. Elettronica
Via del Fonditore, 2/2c
40138 BOLOGNA ITALY
Tel. +39 051 6010506

3. First Aid

All personnel engaged in equipment installation, operation and maintenance must be familiar with first aid procedures and routines.

3.1 Electric shock treatment

3.1.1 If the victim is unconscious

Follow the first aid procedures outlined below.

- Lay the victim down on his/her back on a firm surface.
- the neck and tilt the head backwards to free the airway system (**Figure 1**).

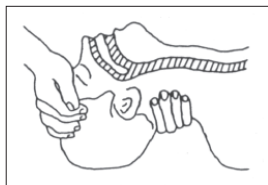

Figure 1

- If needed, open the victim's mouth and check for breathing.
- If there is no breathing, start artificial respiration without delay (**Figure 2**) as follows: tilt the head backwards, pinch the nostrils, seal your mouth around the victim's mouth and give four fast rescue breaths.



Figure 2

- Check for heartbeat (**Figure 3**); if there is no heartbeat, begin chest compressions immediately (**Figure 4**) placing your hands in the centre of the victim's chest (**Figure 5**).

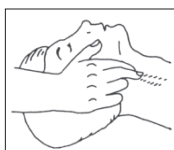

Figure 3

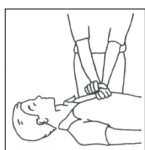

Figure 4

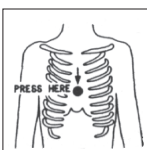

Figure 5

- One rescuer: give 2 quick rescue breaths after each 15 compressions.

- Two rescuers: one rescue breath after each 5 compressions.
- Do not stop chest compressions while giving artificial breathing.
- Call for medical help as soon as possible.

3.1.2 If the victim is conscious

- Cover victim with a blanket.
- Try to reassure the victim.
- Loosen the victim's clothing and have him/her lie down.
- Call for medical help as soon as possible.

3.2 Treatment of electric burns

3.2.1 Large burns and broken skin

- Cover affected area with a clean cloth or linen.
- Do not break any blisters that have formed; remove any clothing or fabric that is stuck to the skin; apply adequate ointment.
- Administer adequate treatment for the type of accident.
- Get the victim to a hospital as quickly as possible.
- Elevate arms and legs if injured.

If medical help is not available within an hour, the victim is conscious and is not retching, administer a solution of table salt and baking soda (one teaspoon of table salt to half teaspoon of baking soda every 250 ml of water).

Have the victim slowly drink half a glass of solution for four times during a period of 15 minutes.

Stop at the first sign of retching.

Do not administer alcoholic beverages.

3.2.2 Minor burns

- Apply cold (not ice cold) strips of gauze or dress wound with clean cloth.
- Do not break any blisters that have formed; remove any clothing or fabric that is stuck to the skin; apply adequate ointment.
- If needed, have the victim change into clean, dry clothing.
- Administer adequate treatment for the type of accident.
- Get the victim to a hospital as quickly as possible.
- Elevate arms and legs if injured.

4. General Description

The **PTX30DDS, PTX100DDS & PTX150DDS** are **FM Direct on Channel professional DDS exciter** (Direct Digital Synthesizer), manufactured by **R.V.R. Elettronica**.

The **PTX30DDS, PTX100DDS & PTX150DDS** are designed to being contained into a 19" rack box of 2HE.

4.1 Unpacking

The package contains:

- 1 **PTX30DDS, PTX100DDS & PTX150DDS**
- 1 User Manual
- 1 Mains power cables

The following accessories are also available from Your R.V.R. Dealer:

- **Options for the machine:**
 - **/SFN-DDS** (isofrequency)
 - **/08DIG-DDS** (I/O digital for Power Good Card)
 - **/09DIG-DDS** (I/O digital for SCM6/1 connection)
 - **/10MHZ-DDS** (External reference input)
 - **/02SCA-DDS** (Additional SCA input)
 - **/EXPRDS-DDS** (Additional RS232 UECP port)
 - **/TLW-DDS-E** (WEB, mail, SNMP1 telemetry)
 - **/TLW-DDS-AOIP** (Web mail and SNMP2 Telemetry & AoIP card)

	/SFN-DDS	/08DIG-DDS	/09DIG-DDS	/10MHZ-DDS	/02SCA-DDS	/EXPRDS-DDS	/TLW-DDS-E	/TLW-DDS-AOIP
/SFN-DDS		•	•	○	•	•	•	•
/08DIG-DDS	•		•	•	•	•	•	•
/09DIG-DDS	•	•		•	•	•	•	•
/10MHZ-DDS	○	•	•		•	•	•	•
/02SCA-DDS	•	•	•	•		•	•	•
/EXPRDS-DDS	•	•	•	•	•		x	x
/TLW-DDS-E	•	•	•	•	•	x		x
/TLW-DDS-AOIP	•	•	•	•	•	x	x	

• : compatible option / ○ : option already included / x : not compatible option

Table 4.1: compatibility table of the options

- **Spare Parts**
- **Cables**

4.2 Features

The **PTX-DDS** FM exciter is based on a DSP input module (TRDSP) followed by an FPGA section that directly generates a low-level, Direct On Channel RF signal, in the FM band. The input DSP module called TRDSP controls all the audio signals

(L, R, MPX, AES-EBU and optional AOIP) that are processed at digital level or, in case of analog signals, L-R and MPX are immediately converted into digital format to be processed afterwards. The modulator section of the **PTX-DDS** generates the modulated RF carrier (with additional and/or optional services like RDS, ITU-412 limiter, SFN, AOIP in according to installed options) directly on the Carrier Frequency, Direct On Channel.

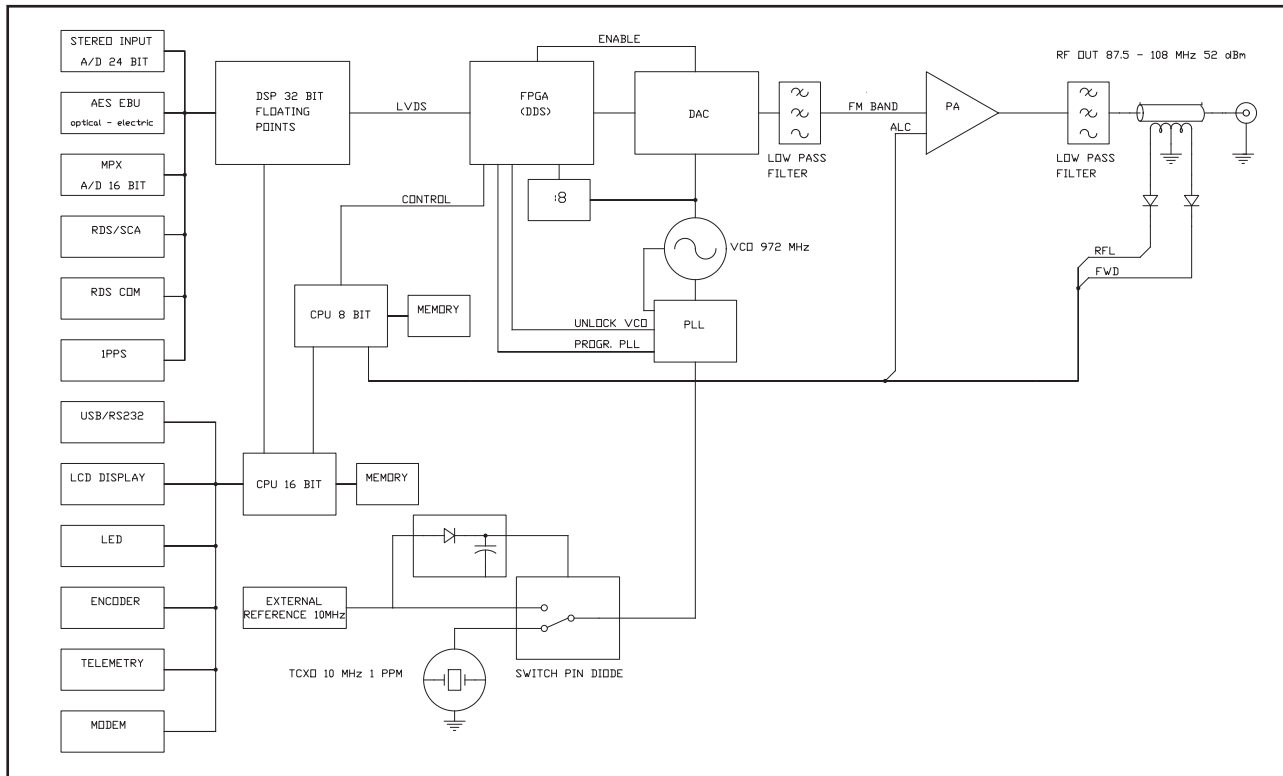

User interface consists of a graphic liquid crystal display and a knob (encoder). This interface lets you view all parameters relating to machine operation and adjust settable parameters (e.g.: power level or operating frequency).

The exciter has been designed to easily integrate into complex transmission systems. To this end, it is capable of accepting data from, controlling or interacting with external equipments, such as amplifiers, switching units, relays or other exciters.

The **PTX-DDS** design is based on a modular concept: the different functions are performed by modules that are connected directly through male and female connectors or through flat cables terminated by connectors. This design facilitates maintenance and module replacement.

A LCD on the front panel and a control knob provide for user interfacing with the microprocessor control system, which implements the following primary feature:

- Set up of the power output
- Set up of the working frequency
- Enabling or disabling of the power output delivery
- Measurement and visualization of the working parameters

On the rear panel is placed the audio section, which allows the interfacement with other devices. From this section are available the analogic connectors for audio input (mono, audio stereo, MPX), digital audio input (AES/EBU electrical and optical), 19kHz pilot tone output and two SCA input for signals modulated on subcarriers from external coders.

The audio section includes functionality of RDS coder, externally programmable through the proper RVR software.

There are also placed the mains power plug, RF output, RF test, the remote connector and the protection fuse.

The equipment foresees several options on request, as GPS board function.

4.3 Frontal Panel Description

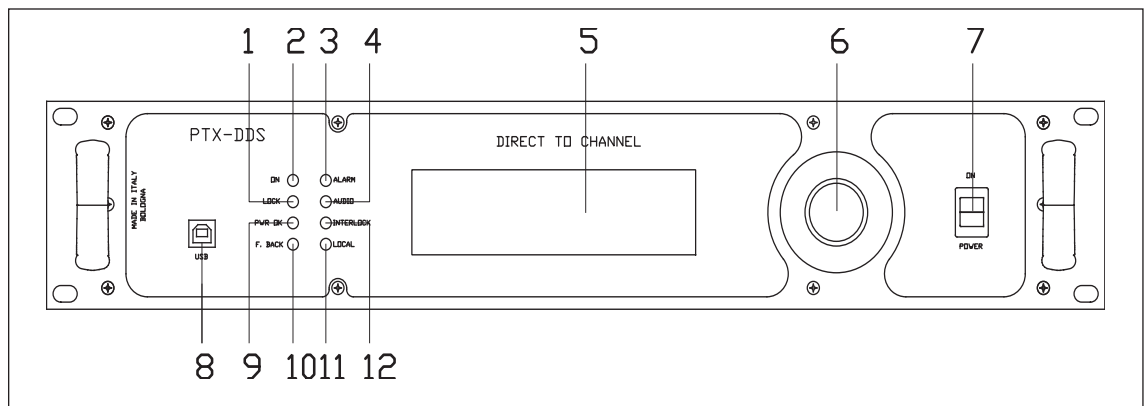

Figure 4.1

[1] LOCK	Green LED, it is lit on when the PLL is locked to working frequency.
[2] ON	Green LED, it is lit on when the exciter is switched on.
[3] ALARM	Red LED, it is lit on in presence of transmitter failure in case of hardware alarms (for example communication lack between the modules). In case the LED flashing, it indicates the temperature alarm.
[4] AUDIO	Red LED, it is lit on when in case of audio lack below the thresholds set up in ALSET menu.
[5] DISPLAY	Liquid Crystal Display, supports both graphics (240x64 pixels).
[6] ENCODER	Software control knob and button.
[7] POWER	Power switch.
[8] USB	USB connector for upgrades and communications with TELECON software.
[9] PWR OK	Green LED, it is lit on when the delivering output power get over the thresholds of PGset set up in PGSET menu.
[10] FOLDBACK	Yellow LED, it is lit on when the foldback function is operating (automatic reduction of the delivered RF power).
[11] LOCAL	Yellow LED, it is lit on when the exciter is set in Local status. In case the LED flashing, it indicates communications ahead between exciter and TELECON software.
[12] INTERLOCK	Red LED, it is lit on when exciter is not delivering power because inhibited by an interlock signal.

4.4 Rear Panel Description

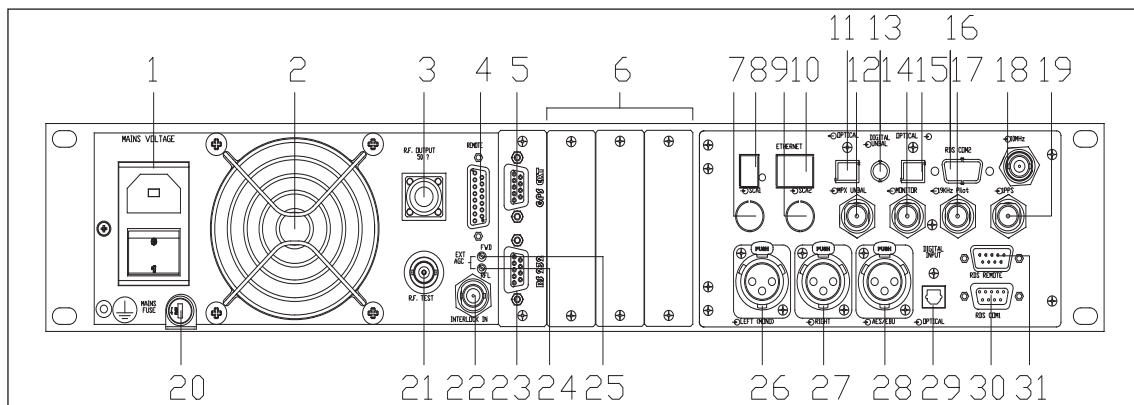

Figure 4.2

- | | |
|-----------------------|--|
| [1] PLUG | Mains power plug and Mains power switch. |
| [2] FAN | Forced cooling fan. |
| [3] RF Output | RF output connector, N-type, 50Ω. |
| [4] Remote | DB15 connector for telemetry of the machine. |
| [5] GPS EXT | DB9 connector for communication with external GPS receiver like GPSRXNV-01 manufactured by R.V.R. Elettronica. |
| [6] SLOT | Slot allocation for the options. |
| [7] SCA1 | BNC input connector, SCA1 unbalanced (optional). |
| [8] DIGITAL OUT | Not available (reserved for future uses). |
| [9] USB | USB connector for the reading of MP3 files (optional with /TLW-DDS-AOIP). |
| [9] SCA2 | BNC input connector, SCA2 unbalanced (optional). |
| [10] LAN | RJ45 connector for TCP/IP communication (optional with /TLW-DDS-E or /TLW-DDS-AOIP). |
| [11] OPTICAL OUT | Not available (reserved for future uses). |
| [12] MPX UNBAL | BNC input connector, MPX unbalanced. |
| [13] DIGITAL UNBAL IN | Not available (reserved for future uses). |
| [14] MONITOR | BNC output connector for internal MPX signal monitoring. |
| [15] OPTICAL IN | Not available (reserved for future uses). |
| [16] RDS COM 2 | DB9 connector for RDS data serial communication (optional with /EXPRDS-DDS). |
| [17] 19 kHz pilot | BNC output connector for output tone control, may be used to synchronise external devices (such as RDS coder). |
| [18] 10MHz | BNC input connector for carrier synchronism signal from external devices (such as GPS receiver). Optional with /SFN-DDS or /10MHZ-DDS) |
| [19] 1PPS | BNC connector for TTL signal input of 1PPS (such as GPS receiver). |
| [20] FUSE | Power supply fuse (6.3AT/250V/5x20). |
| [21] RF TEST | BNC output connector for test output at 30 dB below carrier. |
| [22] INTERLOCK IN | BNC connector for interlock. In case of central conductor is connected to ground,the transmitter is placed into forced standby mode. |
| [23] RS232 | DB9 connector for direct serial communication. |
| [24] EXT AGC RFL | Trimmer for automatic gain control based on external signal of reflected power. |
| [25] EXT AGC FWD | Trimmer for automatic gain control based on external signal of forward power. |
| [26] LEFT (MONO) | XLR input connector for left or mono channel . |
| [27] RIGHT | XLR input connector for right channel . |
| [28] AES/EBU | XLR input connector for AES/EBU digital audio input. |
| [29] OPTICAL | TOS-LINK connector for digital audio input in optical fiber. |
| [30] RDS COM 1 | DB9 connector for RDS data serial communication. |
| [31] RDS REMOTE | DB9 connector for electromechanical remote interface. |

4.5 Connector Pinouts

4.5.1 Remote

Type: DB15 female

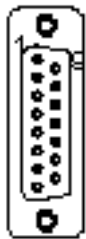

1	Ext Rem	Interlock input, disables tx if connected to ground
2	Ext Fwd Pwr	Analogue input for forward power from external amplifier
3	GND	GND
4	Analogue Input 5 (0 - 5V) or I ² C bus SDA (*)	
5	Analogue Input 3 (0 - 5V)	
6	Analogue Input 1 (0 - 5V)	
7	RLY 2 Out	Digital output. Normally open relay contact (*)
8	GND	GND
9	GND	GND
10	Ext Rfl Pwr	Analogue input for reflected power from external amplifier
11	Analogue Input 6 (0 - 5V) or I ² C bus SCL or mains alarm input signalling (*)	
12	Analogue Input 4 (0 - 5V)	
13	Analogue Input 2 (0 - 5V)	
14	GND	GND
15	RLY 1 Out	Digital output. Normally open relay contact (*)

(*) : the function is determined by dip-switches SW1 and SW2 on the panel card.

4.5.2 RS232, RDS COM 1 & RDS COM 2

Type: DB9 female



1	NC
2	TX_D
3	RX_D
4	NC
5	GND
6	+12V
7	NC
8	CTS
9	NC

4.5.3 Left (MONO) / Right

Type: XLR female



1	GND
2	Positive
3	Negative

4.5.4 GPS EXT

Type: DB9 female

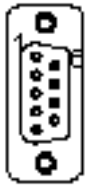

- | | |
|---|----------------|
| 1 | PS FAULT INPUT |
| 2 | Reserved |
| 3 | Reserved |
| 4 | NC |
| 5 | GND |
| 6 | Reserved |
| 7 | GND |
| 8 | NC |
| 9 | NC |

4.5.5 RDS REMOTE

Type: DB9 male

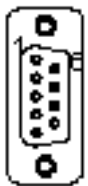

- | | |
|---|----------|
| 1 | GND |
| 2 | RDS MS |
| 3 | RDS TA |
| 4 | RDS TP |
| 5 | +3V3 |
| 6 | Reserved |
| 7 | Reserved |
| 8 | Reserved |
| 9 | Reserved |

4.5.6 ETHERNET(Optional)

Type: RJ45 female

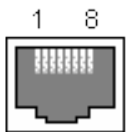

- | | |
|---|-----|
| 1 | TX+ |
| 2 | TX- |
| 3 | RX+ |
| 4 | NC |
| 5 | NC |
| 6 | RX- |
| 7 | NC |
| 8 | NC |

4.5.7 OPTICAL IN

Type: Female TOS-LINK



5. Quick guide for installation and use

This section provides a step-by-step description of equipment installation and configuration procedure. Follow these procedures closely upon first power-on and each time any change is made to general configuration, such as when a new transmission station is added or the equipment is replaced.

Once the desired configuration has been set up, no more settings are required for normal operation; at each power-up (even after an accidental shutdown), the equipment defaults to the parameters set during the initial configuration procedure.

The topics covered in this section are discussed at greater length in the next sections, with detailed descriptions of all hardware and firmware features and capabilities. Please see the relevant sections for additional details.



IMPORTANT: When configuring and testing the transmitter in which the equipment is integrated, be sure to have the Final Test Table supplied with the equipment ready at hand throughout the whole procedure; the Final Test Table lists all operating parameters as set and tested at the factory.

5.1 Using the encoder

The interaction between the user and the exciter's control software is performed using the encoder.

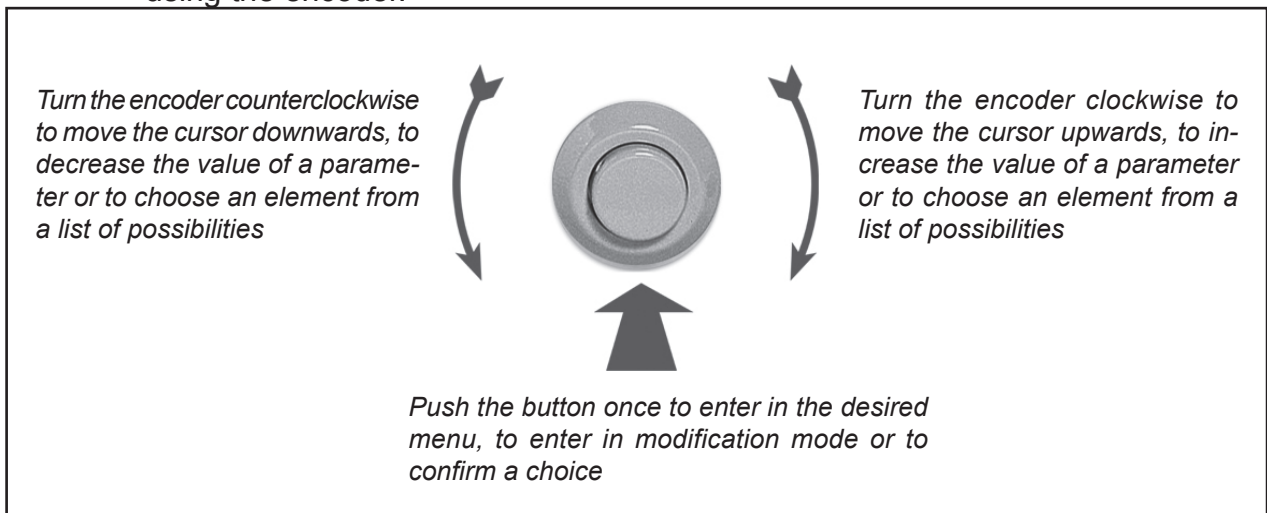

Figure 5.1

The possible operations that you can carry out on the encoder are:

- **rotation:** moves the cursor shown on the display; if you turn the encoder to the left (counterclockwise), the cursor moves downwards, if you turn it right the cursor moves upwards; it also permits to increase or diminish the parameters (turning the encoder left diminishes the parameter, turning it right increases it) or to select an item from a list of options.

- **pushing:** push the button once when the cursor is on the name of a menu to enter in that menu, push it when the cursor is on the name of a parameter to enter in modification mod (the cursor starts blinking); after the modification of a parameter, push the button to save the new value.

After having modified the value of a parameter, the cursor goes on blinking for approximately 10 seconds, waiting for confirmation from the user. If the user doesn't confirm the new value (i.e., the button is not pressed), the cursor stops blinking and remains on the selected parameter.

If no controls are operated during 2 minutes, the exciter returns to the default menu, and after 5 minutes of inactivity the display lighting will be turning off.

5.2 Preparation

5.2.1 Preliminary checks

Unpack the transmitter and immediately inspect it for transport damage. Ensure that all connectors are in perfect condition.

Provide for the following (applicable to operating tests and putting into service):

- ✓ Single-phase 230 VAC (-15% / +10%), or 115 VAC through internal connector, mains power supply with adequate ground connection.
- ✓ For operating tests only: dummy load with 50 Ohm impedance and adequate capacity.
- ✓ Connection cable kit including:
 - Mains power cable

5.2.2 Mains power supply



WARNING: *Disconnect mains power supply before beginning these procedures.*

The mains power supply protection fuse is conveniently located on the rear panel and are easily accessed: to check or replace a fuse, **disconnect machine from power mains**, unscrew fuse cover and pull fuse out of socket.

The following fuse is used:

	@ 115 Vac/230 Vac
Main Power Supply	(1x) 6.3AT type 5x20

Table 5.1: Fuses

5.2.3 Connections

Connect a suitable dummy load with suitable dissipation power, or antenna, or the input of final amplifier (for instance, PJ1000-LIGHT exciter available from R.V.R. Elettronica) to the RF output using a 50-Ohm coaxial cable with “N”-type connectors.



Note: When you connect the **PTX-DDS** to other devices, it is necessary to strictly follow the instructions given by the respective manufacturers, to avoid damages or danger situations.



WARNING: Electric shock hazard. Never handle the RF output connector when the machine is powered on and no load is connected. Injury or death may result.

Ensure that the **POWER** switch on the front panel, and the switch on the rear panel are set to “**OFF**”.

Connect the mains power cable to the MAINS terminal board on the rear panel.



Note: The mains must be equipped with adequate ground connection properly connected to the machine. This is a pre-requisite for ensuring operator safety and correct operation.

Connect your source audio (for example the mixer or STL output) to the suitable input connector. The **PTX-DDS** offers a number of input choices, L+R, MPX or even digital; see the connectors description for details.

5.3 First power-on and setup

Follow this procedure upon first power-on and after making changes to the configuration of the transmitter in which the amplifier is integrated.



Note: Standard factory settings are RF power output Off (**Pwr OFF**) and output power set to upper limit (unless otherwise specified by customer).

5.3.1 Power-on

Question:

The equipment is turn off?

Answer:

- When you have performed all of the connections described in the previous paragraph, power on the amplifier using the suitable power switch on the rear panel. Power on the pilot exciter switch on the front panel. Ensure that the **ON** light turns on. Start up informations should appear briefly on the display, quickly followed by the main readings. If RF output is disabled, these readings will be zero.

5.3.2 Frequency lock check

Question:

The equipment doesn't work correctly?

Answer:

- Ensure that the **LOCK** light turns on. It indicates the PLL is locked to working frequency, wait at least 15 seconds from the power on of **PTX-DDS**.

5.3.3 Power check

Question:

The equipment doesn't work correctly at the power set up?

Answer:

- Ensure that the **INTERLOCK** light turns off. It indicates that no external interlock signal inhibites the delivering power from exciter.
- Ensure that the **F.BACK** light turns off. In counter case indicates the foldback function is operating (automatic reduction of the delivered RF power). To restore the right operation, connect a proper load, or antenna, to the exciter.
- Check current **RF** output setting and enable output (if not already enabled) following menu path **Admin** ⇒ **RfSet** ⇒ **Pwr** ⇒ **ON**. Otherwise is possible enable the output power directly from main menu. Output power can also be set in a Pwr OFF condition; in this condition, (Fwd) output power reading on the display will be 0 (zero), that will be delivered the moment you switch back to Pwr ON state.

- Check output power level and set to maximum level (if not already set to maximum) from the Power Setup Menu, which you can call up by pressing these keys in the order: **Admin** ⇒ **RfSet** ⇒ **Pwr** ⇒ **P.Out**. In alternative is possible adjust the output power directly from main menu.

Use **RfSet** menu to set the desired amplifier output power, whereas the forward power value shown on the display (**Forward: xxx.x W**) gives actual output power reading, and may be lower than set power if an **Automatic Gain Control** is in **limited-power mode**.



IMPORTANT: The transmitter incorporates Automatic Gain Control and output power is modulated based on the power level set by the user and actual operating conditions, such as temperature, reflected power and other parameters.

5.3.4 Changing the Power Good alarm threshold

Change Forward Power Good alarm setting **PgFWD** from the **Admin** ⇒ **PgSet** menu as required (factory setting is 50%).

5.3.5 Changing the internal dip-switch configuration

To change the dip-switch configuration open the upper cover; switch off the equipment (if it power on) and disconnect the mains power cable, then unscrewing all the screw present. Remove the cover and identify the panel card (see figure below); configure the dip-switch referred to the own necessity.

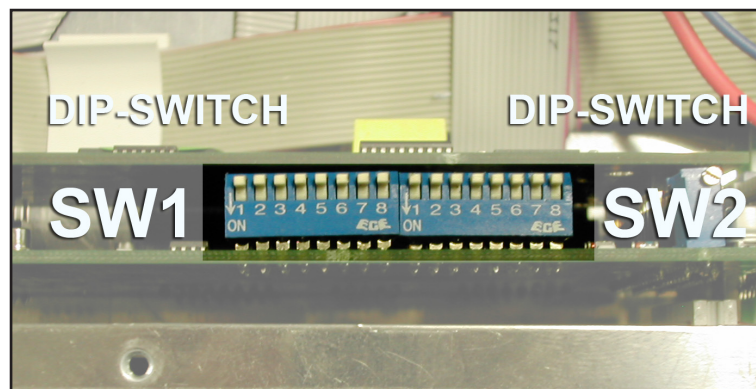

Figure 5.2

Dip-Switch	Set ON	Set OFF
1 (SW1)	- I ² C Bus disconnected. - Analogic Input 5 activated. - Analogic Input 6 activated.	- I ² C Bus connected. - Analogic Input 5 deactivated. - Analogic Input 6 deactivated.
2 (SW1)	Not used	Not used
3 (SW1)	Not used	Not used
4 (SW1)	- Mains Alarm on analogic input 6 activated	- Mains Alarm on analogic input 6 deactivated
5 (SW1)	- RLY1 and RLY2 enabled for power good output.	- RLY1 and RLY2 enabled for ON/OFF output.
6 (SW1)	- RLY1 output activated for reflected power good signalling.	- RLY1 output activated for audio alarm signalling.
7 (SW1)	Not used	Not used
8 (SW1)	Not used	Not used
1 (SW2)	- Vmeter bar in kHz	- Vmeter bar in "%"
2 (SW2)	Not used	Not used
3 (SW2)	Not used	Not used
4 (SW2)	Not used	Not used
5 (SW2)	Not used	Not used
6 (SW2)	Not used	Not used
7 (SW2)	Not used	Not used
8 (SW2)	Not used	Not used

Table 5.2: Dip-Switch configurations

5.3.6 How to enable Local mode

Question:

The equipment don't accept command through Control knob?

Answer:

- Check current mode setting and enable **Local mode** (if not already enabled) following menu path **Admin** ⇒ **PgSet** ⇒ **Loc** ⇒ **Local**: if left disabled, the machine will not accept the next commands.

5.3.7 How to enable Remote mode

If you wish to use the telemetry control feature, enable Remote control in the **Admin** ⇒ **PgSet** ⇒ **Loc** ⇒ **Local** menu.



Note: In the **Remote** mode the control knob, except **Remote/Local** (for switching back to Local mode), are disabled. Operating parameter readings are available.

5.3.8 Changing the external dip-switch configuration

To change the external dip-switch configuration; switch off the equipment (if it power on) and disconnect the mains power cable, then unscrewing all the screws present.

Remove the equipment from the rack and identify the bottom panel (see figure below); configure the dip-switch referred to the own necessity.

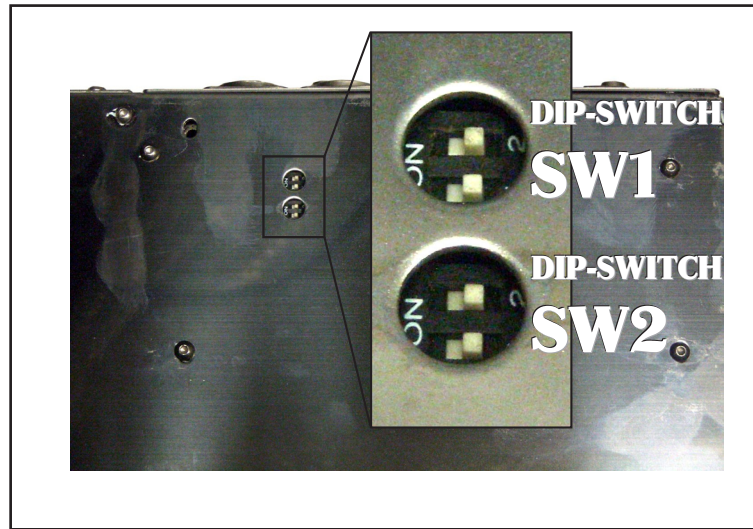

Figure 5.3

Dip-Switch	ON position	OFF position
1 & 2 (SW1)	L&R Input Impedance 600 Ω	L&R Input Impedance 10 kΩ
1 & 2 (SW2)	L&R Input Attenuation 12 dB	L&R Input Attenuation 0 dB

Table 5.3: Dip-Switch configurations

6. Operating System

The exciter is controlled by a microprocessor system. Software operations may be grouped into two broad categories: start-up and normal operation.

6.1 Start-up

Upon switch-on, a window that holds the RVR logo and machine informations appears on the display. The informations regards the firmware release and the programming table.



Note: during the start-up operation don't press or turn the encoder.

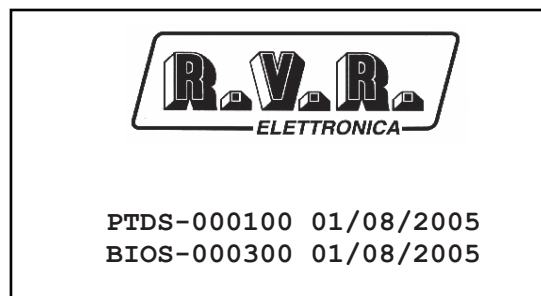

Figure 6.1

Otherwise, in substitution of the RVR logo, are available informations regarding equipment personalization, arranged on three rows of 16 characters.

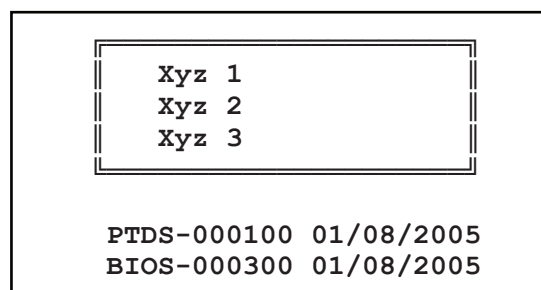

Figure 6.2

After approximately 10 seconds this screen is replaced with the default screen.

6.2 Operating System

The **PTX-DDS** menu system consists of a default menu and set of administration menus.

The logic of the organization of the display is represented in the figures belows.

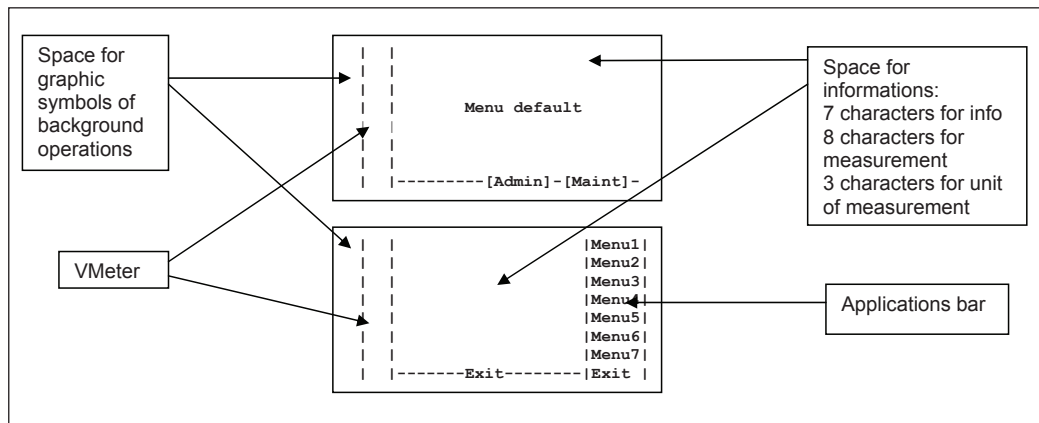

Figure 6.3

6.2.1 Common menu elements

In normal operation the equipment introduces default menu where are visualized the fundamental working parameters and comes characterizes two menu levels:

`Maint` Maintenance level where the equipment measures are only visualized, the operation parameters cannot be modified.

`Admin` Management level where are present all the equipment settings.

The visualization menu and the measure description can be available in several languages, depending the version.

6.2.1.2 Input modulation deviation bar (Vmeter)

The modulation sent to DDS is displayed as vertical bar in the left portion of the screen. The visualization of the bars in kHz or in percentage is determined by dip-switch SW2 on the panel card.

6.2.1.3 Graphic symbols

This graphic bar, placed on the left portion of the screen, shown the information icons relates to communication through TELECON.

- Icon for signalling the IIC communication
- Icon for signalling the RS232 communication
- Icon for signalling the happened audio commutation on one of the two secondary channels
- Icon for signalling the happened power reduction during SFN operation
- Icon for signalling the presence of the internal or external signal reference of 10MHz



Icon for signalling the detection of SPB490 data in RDS signal reception

6.3 Menu Organization

6.3.1 Default menu (MAIN)

This is an information screen; it shows the main amplifier measures, most of this cannot be modified. Only RF Status, Frequency and Power Output are quickly modifiable from this menu.

If the illumination of the display is turned off, the first pressure or rotation of the encoder cause the lighting.

To change the editable parameters press the encoder, turn until the indicator is highlighted on the desired menu and then press again to confirm. The setting of the value is now possible by the rotating of the encoder.

After having modified the value of a parameter, the cursor goes on blinking for approximately 10 seconds, waiting for confirmation from the user. If the user doesn't confirm the new value (i.e., the button is not pressed), the cursor stops blinking and remains on the selected parameter.

To access to the Maintenance submenus or to the Administrator submenus press the encoder, turn until the indicator is highlighted on the desired menu and then press again to confirm.

If no controls are operated through the encoder during 2 minutes, the exciter returns to this menu and after 5 minutes of inactivity the display lighting will be turning off..

```

| | RF Status: Off
| | Frequency: 000.000 MHz
| | Power Out: 000 %
| | Forward : 000.0 W
| | Reflected: 000.0 W
| | Ch. Input: Analog
| | Lev. Input: +00 +00 dBu
| |----- ---[Admin]-[Maint]-

```

Figure 6.4

RF Status	Visualization of the equipment power status
Frequency	Visualization of the working frequency
Power Out	Visualization of the output power expressed in percentage
Forward	Visualization of the forward power expressed in Watt
Reflected	Visualization of the reflected power expressed in Watt
Ch. Input	Visualization of the source on input audio channel that is generating modulation

lev. Input Visualization of the audio level necessary to obtain the 100% of FM deviation expressed in dBu or dBfs

6.3.2 Maintenance menu (Maint)

Under this menu are available detailed information regarding the status of the equipment, most of these cannot be modified but are only visualized.

Turning the encoder, you can move the cursor to the next submenu label, while its informations and measures appears in the centre of the window.

To return to the default menu, rotate the encoder until the “EXIT” label is highlighted, then press to exit the Maintenance submenu.

In alternative you can avoid to use the encoder for about 2 minutes to return to the default menu automatically.

6.3.2.1 RF measures submenu (RFmea)

This menu provides general information on the RF measures of the exciter.

	RF	: On		
	Freq.	: 000.000Mhz		
	FWD	: 0.0 W		
	RFL	: 0.0 W		
	RDS	: On		
	SFN	: On		
	FSK	: On		
	Maint	-----		

Figure 6.5

RF	Visualization of the equipment power status
Freq	Visualization of the working frequency
Fwd	Visualization of the forward power expressed in Watt
Rfl	Visualization of the reflected power expressed in Watt
RDS	Visualization of the internal RDS status
SFN	Visualization of the reduction power status for isofrequencies application
FSK	Visualization of the FSK status

6.3.2.2 Power amplifier measures submenu (PAmea)

This menu provides general information on the power amplifier measures.

```

| |VPA   : 00.0  V | | |
| |IPA   : 00.0  A | |
| |VCO   : 00.0  V | |
| |Temp. : + 00  °C | |
| |      |          | |
| |ExtFWD:000.0  % | |
| |ExtRFL:000.0  % | |
| |Maint-----| |
    
```

Figure 6.6

VPA	Visualization of the feeding voltage of power amplifier expressed in Volt.
IPA	Visualization of the absorbed current of power amplifier expressed in Ampere.
VCO	Visualization of the voltage applied to VCO section expressed in Volt.
Temp .	Visualization of the amplifier module temperature expressed in degrees centigrade.
ExtFWD	Visualization of the forward power supplied by external amplifier expressed in percent.
ExtRFL	Visualization of the reflected power supplied by external amplifier expressed in percent.

6.3.2.3 Audio level submenu (AuLev)

This menu provides general information on the input audio level measures of the exciter.

		Ana. R:+00.0	dBr	
		Ana. L:+00.0	dBr	
		Dig. R:+00.0	dBr	
		Dig. L:+00.0	dBr	
		MX/SCA:+00.0	dBr	
		Maint	-----	

Figure 6.7

Ana. R	Visualization of the right analogic channel level expressed in decibel (dBr).
Ana. L	Visualization of the left analogic channel level expressed in decibel (dBr).
Dig. R	Visualization of the left digital channel level expressed in decibel (dBr).
Dig. L	Visualization of the left digital channel level expressed in decibel (dBr).
MX/SCA	Visualization of the composite channel level expressed in decibel (dBr).

6.3.2.4 Audio control submenu (AuCnt)

This menu provides general information on the audio control measures of the exciter.

```

| |Clip. :OFF      | |
| |ClipLR:+00.0 dB | |
| |Clip X:+00.0 dB | |
| |              | |
| |Ph.Ana:+(L = R) | |
| |Ph.Dig:+(L =-R) | |
| |PhsMpx:-( MPX ) | |
| |Maint-----| |
    
```

Figure 6.8

Clip	Visualization of the clipper status
ClipLR	Visualization of the clipping level regulation for the right and left channels expressed in decibel.
Clip X	Visualization of the clipping level regulation for the composite channel expressed in decibel.
PhsAna	Visualization of the analogic channels phase modality.
PhsDig	Visualization of the digital channels phase modality.
PhsMPX	Visualization of the composite channel phase modality.

6.3.2.5 Board control submenu (BdCnt)

This menu provides general information on the exciter control adjustments of the exciter.

```

| |Input :Analog | |
| |Mode A:Mono | |
| |Mode D:Auto | |
| |Mode X:Stereo | |
| |Preemp: 50 uS | |
| |PilLev:+00.0 dB | |
| |PilPhs:+00.0 Deg| |
| |Maint-----| |

```

Figure 6.9

Input	Visualization of the audio input modality or the automatic rescuer activation.
Mode A	Visualization of the coder modality in analogic operation.
Mode D	Visualization of the coder modality in digital operation.
Mode X	Visualization of the coder modality in composite operation.
Preemp	Visualization of the preemphasis selection expressed in microseconds.
PilLev	Visualization of the level correction adjustment of the pilot generated expressed in decibel.
PilPhs	Visualization of the level correction adjustment of the pilot generated expressed in degrees.

6.3.2.6 Output level submenu (OuLev)

This menu provides general information on the output level measures.

```

| |Dig. R:+00.0 dBf| | |
| |Dig. L:+00.0 dBf| |
| | | | |
| |Monit.:+00.0 dBu| |
| | | | |
| |Pilot :+00.0 dBu| |
| | | | |
| |Maint-----| |
    
```

Figure 6.10

- Dig. R Visualization of the ouput level for the right digital channel expressed in decibel (dBfs).
- Dig. L Visualization of the ouput level for the left digital channel expressed in decibel (dBfs).
- Monit. Visualization of the ouput level for the Monitor channel expressed in decibel (dBu).
- Pilot Visualization of the pilot tone level expressed in decibel (dBu).

6.3.2.7 I.T.U. and A.G.C status Submenu (ITUst)

This menu provides general information on the ITU (International Telecommunications Union) and AGC (Automatic Gain Control) setups.

	ITU :On		
	ITUlev:+00.0 dB		
	ITUadj:+00.0 dBr		
	AGC :OFF L&R		
	AGC LR:+00.0 dB		
	AGC :OFF MPX		
	AGC X:+00.0 dB		
	Maint -----		

Figure 6.11

ITU	Visualization of the ITU functionality status.
ITUlev	Visualization of the ITU level expressed in decibel.
ITUadj	Visualization of the ITU level adjustment expressed in decibel (dBr).
AGC	Visualization of the intervention speed selection for the left and right channels.
AGC LR	Visualization of the intervention level for the left and right channels expressed in decibel.
AGC	Visualization of the intervention speed selection for the composite channel.
AGC X	Visualization of the intervention level for the composite channel expressed in decibel.

6.3.2.8 RDS status submenu (RDSst)

This menu provides general information on the RDS (Radio Data System) setups.

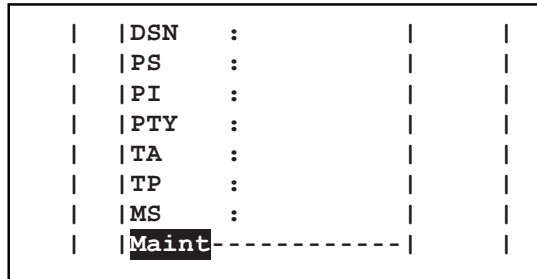

Figure 6.12

- DSN Visualization of the DSN put on the air (Data Source Name).
- PS Visualization of the text put on the air (Program Service).
- PI Visualization of the code put on the air (Program Identification).
- PTY Visualization of PTY (Program TYpe) status.
- TA Visualization of TA (Traffic Announcement) status.
- TP Visualization of TP (Traffic Program identification) status.
- MS Visualization of MS (Music/Speech) status.

6.3.2.9 External status submenu (EXTst)

This menu provides general information on the external analogic status.

	V1	:	0.00	V		
	V2	:	0.00	V		
	V3	:	0.00	V		
	V4	:	0.00	V		
	V5	:	Disabled			
	V6	:	Disabled			
	MAINS	:	Disabled			
	Maint	:	-----			

Figure 6.13

V1	Visualization of the input voltage on pin 6 of REMOTE connector expressed in Volts (max 5 V).
V2	Visualization of the input voltage on pin 13 of REMOTE connector expressed in Volts (max 5 V).
V3	Visualization of the input voltage on pin 5 of REMOTE connector expressed in Volts (max 5 V).
V4	Visualization of the input voltage on pin 12 of REMOTE connector expressed in Volts (max 5 V).
V5	Visualization of the input voltage on pin 4 of REMOTE connector expressed in Volts (max 5 V) or if disabled for IIC function.
V6	Visualization of the input voltage on pin 11 of REMOTE connector expressed in Volts (max 5 Volts) or if disabled for IIC function.
MAINS	Visualization of the MAINS input status if enabled on pin 11 of REMOTE connector.

6.3.2.10 Alarms list submenu (AlmLt)

This menu provides general information on the last twenty alarms stored in a non volatile memory from the exciter.

In case the buffer is full, the previous alarms stored will have replaced with the new one, normally it visualized the last alarm saved in memory.

To change the alarm displayed press the encoder, turn until the indicator is highlighted on the “Alarm” label and then press again to confirm. Select one of the twenty alarms choose itself from the list of alarms 1 ... 20 using the encoder.

If the user confirm or doesn't confirm the new value (i.e., the button is not pressed), the cursor stops blinking and remains on the first alarm stored.

To erase all the stored events use again the encoder, move cursor to “RESET” and confirm reset operation.

To exit from this submenu rotate the encoder until the “EXIT” label is highlighted, then press the encoder to confirm and return to Maintenance submenu navigation.

```

| |Alarm : 1 RESET | | | |
| | | | | |
| |Date :00/00/00 | |
| |Time : 00:00 | |
| |Name : | |
| | Forward Power | |
| | | | | |
| |Maint---[Exit]---| |
    
```

Figure 6.14

Alarm	Visualization and selection of the stored alarm number.
Reset	Selection for the alarms reset, this operation erases all stored events.
Date	Visualization of the alarm record date expressed as dd/MM/yy.
Time	Visualization of the alarm record time expressed as HH:mm.
Name	Visualization of the of stored alarm name.

6.3.2.11 Firmware informations submenu (Info)

This menu provides general information on the firmware installed and jumper setting in the exciter.



Note: if the version isn't supported is displayed "!!!ERROR!!!" (i.e.: after a new release firmware upgrade).

```

| |Bios:BIOS-000300 | |
| |App. :PTDS-000100 | |
| |Pan. :PDDS-000100 | |
| |Aud. :TRDP-000100 | |
| |Tab :PDDS-0150-01| |
| |Jumper: | |
| |12345678 12345678| |
| |Maint-----| |
  
```

Figure 6.15

Bios	Visualization of the bios release code.
App	Visualization of the application release code.
Pan.	Visualization of the panel release code.
Aud.	Visualization of the TRDSP release code.
Tab	Visualization of the configuration table code.
Jumper	Visualization of the status for the sixteen jumpers present on panel card. In case some jumpers is not been enabled, a "X" label appears in place of the number.

6.3.2.12 Modem informations submenu (InfoM)

This menu provides general information on the modem in case it is installed.

```

| |SCN:+393359609600| |
| |Nam:I TIM          | |
| |SigLev:-99        dB| |
| |Retry : 0         | |
| |Dial :ATDT        | |
| |N. SMS: 50        | |
| |Stat.:Not in use  | |
| |Maint-----| |

```

Figure 6.16

SCN	Visualization of the Service Centre Number.
Nam	Visualization of the customer number manager.
SigLev	Visualization of the GSM signal level received in antenna expressed in dB.
Retry	Visualization of the SMS transmission attempts in case of alarms.
Dial	Visualization of the initialisation string used by modem.
N. SMS	Visualization of the number of SMS that the SIM card can store.
Stat.	Visualization of the modem status.

6.3.3 Administration menu (Admin)

Under this menu are available advanced information regarding the status of the equipment and most of these can be modified.

Turning the encoder, you can move the cursor to the next submenu label, while its informations and measures appears in the centre of the window.

To return to the default menu, rotate the encoder until the “EXIT” label is highlighted, then press to exit the Maintenance submenu.

In alternative you can avoid to use the encoder for about 2 minutes to return to the default menu automatically.

To access to the several submenus present press the encoder, turn until the indicator is highlighted on the desired editable parameters and then press again to confirm. To exit from this submenu rotate the encoder until the “EXIT” label is is highlighted, then press the encoder to confirm and return to Administration submenu navigation.

To change the editable parameters press the encoder, turn until the indicator is highlighted on the desired parameter label and then press again to confirm. The setting of the value is now possible by the rotating of the encoder.

After having modified the value of a parameter, the cursor goes on blinking for approximately 10 seconds, waiting for confirmation from the user. If the user doesn't confirm the new value (i.e., the button is not pressed), the cursor stops blinking and remains on the selected parameter.

6.3.3.1 RF setting submenu (RFset)

This menu provides general the RF setting of the exciter.

```

| |RF      :On      | |
| |Freq.  :000.000Mhz| |
| |F.Step:000      kHz| |
| |P.Out  :000      % | |
| |Rise t:000      Sec| |
| |FWD   : 0.0     W | |
| |RFL   : 0.0     W | |
| |Admin---[Exit]---| |
    
```

Figure 6.17

RF	Selection of the equipment power status. The status can be set ON (RF power output enabled) or OFF (RF power output disabled).
Freq	Selection of the working frequency. In case that the end of scale comes reached during the setting, you will bring back to beginning of scale. This editable parameter is expressed in megahertz.
F.Step	Selection of the step, for the regulation of the working frequency expressed in kilohertz. The adjustment of the value is available in step of 1, 10, 100 or 1000 kHz.
P.Out	Selection of the output power percentage desired from 0 (output power disabled) to 100%.
Rise t	Selection of the duration time regarding the power ascent ramp. The adjustment of the value is available step of 1 s from 0 to 10 s.
FWD	Visualization of the forward power expressed in Watt.
RFL	Visualization of the reflected power expressed in Watt.

6.3.3.2 Power general submenu (PGset)

This menu provides the Power Amplifier setting of the exciter.

```

| |Status:Local      | |
| |Pg FWD:000      % | |
| |Pg RFL:000      % | |
| |RLY1 :On        | |
| |RLY2 :On        | |
| |PPSsig:Present  | |
| |GPSsig:Present  | |
| |Admin---[Exit]---| |

```

Figure 6.18

- Status Selection of the equipment mode of operation. The status can be set “Local” (all settings included in the software are available, whereas the telemetry inputs are inhibited) or “Remote” (no changes may be made from equipment menus, and telemetry inputs are enabled).
- Pg FWD Selection of the threshold level for “forward power good” signal. Level is expressed as percentage of set power level. The activation of power good is on when **PTX-DDS** actual output power exceeds this percentage of nominal power. For example: assuming that power set in the default menu is 70% of machine rated power (i.e.: **PTX100DDS** 70% x 100W = 70W) and PG1 is set to 80% in the menu under discussion, the PG1 output at PIN 9 of the telemetry card will be on when actual output power exceeds (i.e.: **PTX100DDS** 80% x 70W = 56W).
- Pg RFL Selection of the threshold level for “reflected power good” signal. Level is expressed as percentage of set power level. The activation of power good is on when **PTX-DDS** actual output power exceeds this percentage of nominal power. Pg RFL operates on the same logic as Pg FWD.
- RLY1 Visualization of the “Relay 1” status on the DB15 interface (Pin 15).
- RLY2 Visualization of the “Relay 2” status on the DB15 interface (Pin 7).
- PPSsig. Visualization of the PPS signal status coming from the TRDSP board.
- GPSsig. Visualization of the GPS signal status coming from the GPS option.

6.3.3.3 Audio regulation submenu (AuREG)

This menu provides the audio level setting of the exciter.

When the exciter is set in STEREO mode from the BdSet menu, the same level adjustment is forced on both channels.

The enabling for SCA operation is dependent also from the selection into the BdSet menu.

		Ana. R:+00.0	dBu		
		Ana. L:+00.0	dBu		
		Dig. R:+00.0	dBf		
		Dig. L:+00.0	dBf		
		MPX	:+00.0 dBu		
		SCA1	:+00.0 dBu		
		SCA2	:+00.0 dBu		
		Admin	---[Exit]---		

Figure 6.19

- Ana. R Selection of the right analogic channel level expressed in decibel. The adjustment of the level is available in step of 0.1 dBu ±12.5 dBu.
- Ana. L Selection of the left analogic channel level expressed in decibel. The adjustment of the level is available in step of 0.1 dBu ±12.5 dBu.
- Dig. R Selection of the left digital channel level expressed in decibel. The adjustment of the level is available in step of 0.1 dBfs from 0 to -25.0 dBfs.
- Dig. L Selection of the left digital channel level expressed in decibel. The adjustment of the level is available in step of 0.1 dBfs from 0 to -25.0 dBfs.
- MPX Selection of the composite channel level expressed in decibel. The adjustment of the level is available in step of 0.1 dBu ±12.5 dBu.
- SCA1 Selection of the SCA1 (Single Connector Attachment) channel level expressed in decibel. The adjustment of the level is available in step of 0.5 dBu from -30 to +13 dBu. In OFF position the channel is disabled.
- SCA2 Selection of the SCA2 (Single Connector Attachment) channel level expressed in decibel. The adjustment of the level is available in step of 0.5 dBu from -30 to +13 dBu. In OFF position the channel is disabled.

6.3.3.4 Audio setting submenu (AuSet)

This menu provides the audio control setting of the exciter.

	Clip. :OFF		
	ClipLR:+00.0 dB		
	Clip X:+00.0 dB		
	Ph.Ana:(L = R)+		
	Ph.Dig:(L =-R)+		
	Ph.Mpx:(MPX)-		
	Admin---[Exit]---		

Figure 6.20

- Clip** Selection of the clipper modality. The status can be set OFF (Clipper disabled), RL (Clipper enabled for Left and Right Channels), MPX (clipper enabled for composite channel) or MPX+RL (Clipper enabled for all channels).
- ClipLR** Selection of the clipping level regulation for the right and left channels expressed in decibel. The adjustment of the level is available in step of 0.1 dB \pm 12.5 dB.
- Clip X** Selection of the clipping level regulation for the composite channel expressed in decibel. The adjustment of the level is available in step of 0.1 dB \pm 12.5 dB.
- Ph.Ana** Selection of the analogic channels phase modality. It maybe normal or inverted (convenient when measuring “Sub to Main”). The status are reproduced in the table below.
- Ph.Dig** Selection of the digital channels phase modality. It maybe normal or inverted (convenient when measuring “Sub to Main”). The status are reproduced in the table below.
- Ph.MPX** Selection of the composite channel phase modality. It maybe normal or inverted (convenient when measuring “Sub to Main”). The status are reproduced in the table below.

Status	Description
+ (L = R)	Normal phase. Right channel in phase with Left channel
+ (L = -R)	Normal phase. Right channel 180° out-of-phase referred to Left channel
- (L = R)	Inverted phase. Right channel in phase with Left channel
- (L = -R)	Inverted phase. Right channel 180° out-of-phase referred to Left channel
+ (MPX)	Normal phase for the MPX channel
- (MPX)	Inverted phase for the MPX channel

Table 6.1

6.3.3.5 Board setting submenu (BdSet)

This menu provides the exciter control setting. In case of passage from Mono to Stereo modality, the left channel adjustments are replicated on the right channel.

```

| |Input :Analog | | |
| |Mode A:Mono | | |
| |Mode D:Auto | | |
| |Mode X:Stereo | | |
| |Preemp: 50 uS | | |
| |PilLev:+00.0 dB | | |
| |PilPhs:+00.0 Deg | | |
| |Admin---[Exit]--- | | |
    
```

Figure 6.21

- Input Selection of the audio input modality or the automatic rescuer activation. The status can be set Analog (analogic inputs), Digital (digital inputs), MPX (composite input) or Auto A-D-X (automatic input rescuer).
- Mode A Selection of the coder modality in analogic operation. The status are reproduced in the table below.
- Mode D Selection of the coder modality in digital operation. The status are reproduced in the table below.
- Mode X Selection of the coder modality in composite operation. The status are reproduced in the table below.
- Preemp Selection of the preemphasis selection expressed in microseconds. The adjustment of the value is available in step of 0, 25, 50 and 75 mS.
- PilLev Selection of the level correction adjustment of the pilot generated expressed in decibel. The adjustment of the level is available in step of 0.1 dB ±12.5 dB referred to -20 dB.
- PilPhs Selection of the level correction adjustment of the pilot generated expressed in degrees centigrade. The adjustment of the level is available in step of 0.1 ° ±12.5 °.

	Mode A	Mode D	Mode X	Description
Stereo	x	x	x	Stereophonic mode
Stereo +RDS	x	x	x	Stereophonic with RDS mode
Mon L	x	x		Monophonic mode with only left channel enabled
Mon L +RDS	x	x		Monophonic with RDS mode and only left channel enabled
MonL+R	x	x		Monophonic mode with right & left channels enabled
MonL+R +RDS	x	x		Monophonic with RDS mode and right & left channels enabled
Mono			x	Monophonic mode
Mono +RDS			x	Monophonic with RDS mode
Auto		x		Automatic mode selection
Auto +RDS		x		Automatic mode selection with RDS
Stereo +SCA	x	x	x	Stereophonic mode and SCA enabled
Stereo +SCA +RDS	x	x	x	Stereophonic with RDS mode and SCA enabled
Mon L +SCA	x	x		Monophonic mode with SCA and only left channel enabled
Mon L +SCA +RDS	x	x		Monophonic with RDS mode, SCA and only left channel enabled
MonL+R +SCA	x	x		Monophonic mode with SCA and right & left channels enabled
MonL+R +SCA +RDS	x	x		Monophonic with RDS mode, SCA and right & left channels enabled
Mono +SCA			x	Monophonic mode and SCA enabled
Mono +SCA +RDS			x	Monophonic with RDS mode and SCA enabled
Auto +SCA		x		Automatic mode selection with SCA enabled
Auto +SCA +RDS		x		Automatic mode selection with RDS and SCA enabled

Table 6.2

6.3.3.6 Output regulation submenu (OuReg)

This menu provides the output level setting of the exciter.

```

| |Dig. R:+00.0 dBf| | |
| |Dig. L:+00.0 dBf| |
| | | | |
| |Monit.:+00.0 dBu| |
| | | | |
| |Pilot :+00.0 dBu| |
| | | | |
| |Admin---[Exit]---| |
  
```

Figure 6.22

- Dig. R Selection of the ouput level for the right digital channel expressed in decibel. The adjustment of the level is available in step of 0.1 dBfs from -12.5 to 0 dBfs.
- Dig. L Selection of the ouput level for the left digital channel expressed in decibel. The adjustment of the level is available in step of 0.1 dBfs from -12.5 to 0 dBfs.
- Monit. Selection of the ouput level for the Monitor channel expressed in decibel. The adjustment of the level is available in step of 0.1 dBu from -12.5 to +6 dBu.
- Pilot Selection of the ouput level for the pilot tone channel expressed in decibel. The adjustment of the level is available in step of 0.1 dBu from -12.5 to +6 dBu.

6.3.3.7 I.T.U. and A.G.C setting Submenu (ITU)

This menu provides the ITU (International Telecommunications Union) and AGC (Automatic Gain Control) setting of the exciter.

```

| | ITU   :On      | | |
| | ITUlev:+00.0 dB | | |
| | ITUadj:+00.0 dBr| | |
| | AGC   :OFF    L&R| | |
| | AGC LR:+00.0 dB | | |
| | AGC   :OFF    MPX| | |
| | AGC X:+00.0 dB | | |
| | Admin---[Exit]---| | |
    
```

Figure 6.23

ITU	Selection of the ITU functionality status. The status can be set ON (ITU enabled) or OFF (ITU disabled).
ITUlev	Visualization of the ITU level expressed in decibel.
ITUadj	Selection of the ITU level adjustment expressed in decibel (dBr). The adjustment of the level is available in step of 0.1 dBr ± 3 dBr.
AGC	Selection of the intervention speed selection for the left and right channels. The status can be set OFF (intervention disabled), SLOW (slow intervention speed), MIDDLE (medium intervention speed) or FAST (rapid intervention speed).
AGC LR	Selection of the intervention level for the left and right channels expressed in decibel. The adjustment of the level is available in step of 0.1 dB from 0 to +12 dB.
AGC	Selection of the intervention speed selection for the composite channel. The status can be set OFF (intervention disabled), SLOW (slow intervention speed), MIDDLE (medium intervention speed) or FAST (rapid intervention speed).
AGC X	Selection of the intervention level for the composite channel expressed in decibel. The adjustment of the level is available in step of 0.1 dB from 0 to +6 dB.

6.3.3.8 RDS setting submenu (RDS)

The menu provides the RDS (Radio Data System) setting of the exciter. The enabling for RDS operation is dependent also from the selection into the BdSet menu.

```

| |RDS   :ON      | |
| |          | |
| |Level  :   0   mV | |
| |          | |
| |Phase  :  0.0  ° | |
| |          | |
| |Admin---[Exit]---| |

```

Figure 6.24

- RDS Visualization of the RDS modality. The status can be displayed ON (RDS coder enabled) or OFF (RDS coder disabled).
- Level Selection of the pilot tone level at 57KHz expressed in millivolt. The adjustment of the level is available in step of 1 mVpp from 0 to 150 mVpp.
- Phase Selection of the pilot tone phase at 57KHz expressed in degrees. The adjustment of the phase is available in step of 0.1 ° from 0 to 360 °.

6.3.3.9 SFN submenu (SFN)

This menu provides the SFN (Single Frequency Network) setting of the exciter.

```

| |P.Red.:ON      | |
| |PpsInt:100    min| |
| |PpsRec: 10    min| |
| |GpsInt:200    min| |
| |GpsRec: 0     min| |
| |Power : 50    %  | |
| |Delay : 0.000 us| |
| |Admin---[Exit]---| |
    
```

Figure 6.25

Enable	Selection of the SFN modality in case of synchrony lack. The status can be displayed ON (power reduction enabled) or OFF (power reduction disabled). If SFN function is not enabled on the TRDSP, the parameter comes forced to OFF position.
PpsInt	Selection of the power reduction intervention in case of PPS signal lack expressed in minutes. The adjustment of the value is available in step of 1 min from 0 to 240 min.
PpsRec	Selection of the power recovery intervention in case of PPS signal lack. The adjustment of the value is available in step of 1 min from 0 to 240 min.
Gpsint	Selection of the power reduction intervention in case of GPS signal failure. The adjustment of the value is available in step of 1 min from 0 to 240 min.
GpsRec	Selection of the power recovery intervention in case of GPS signal failure. The adjustment of the value is available in step of 1 min from 0 to 240 min.
Power	Selection of the power reduction proportion in case of activation function expressed in percentage. The adjustment of the value is available in step of 1 % from 0 to 100 %.
Delay	Selection of the audio delay for synchronization expressed in milliseconds. The adjustment of the value is available in step of 100 mS from 0 to 10 mS. If SFN function is not enabled on the TRDSP, the parameter comes written as Disabled.

6.3.3.10 FSK submenu (FSK)

This menu provides the FSK (Frequency Shift Keying) setting of the exciter.

```

| |Enable:OFF      | | |
| |Offset: 10    kHz| | |
| |ReTime: 10    min| | |
| |Code  :RVRCOD  | | |
| |              | | |
| |              | | |
| |              | | |
| |Admin---[Exit]---| | |

```

Figure 6.26

- Enable Selection of the FSK modality. The status can be displayed ON (FSK function enabled) or OFF (FSK function disabled).
- Offset Selection of the frequency offset of character transmission expressed in kilohertz. The adjustment of the value is available in step of 1 kHz from 10 to 90 kHz.
- ReTime Selection of the repetition time for Morse code transmission expressed in minutes. The adjustment of the value is available in step of 1 min from 10 to 240 min.
- Code Selection of the Morse code sended (typically composed from a character, three figures and two characters).

6.3.3.11 Alarms setting submenu (AlSet)

This menu provides the alarm setting of the exciter.

		FWD	:	00%	000s	
		RFL	:	00%	000s	
		Audio	:	00kHz	000s	
		Mains	:		000s	
		ExtFWD	:	00%	000s	
		ExtRFL	:	00%	000s	
		Admin	---	[Exit]	---	

Figure 6.27

- FWD Selection of the alarm activation level in case of forward power lack expressed in percentage. The adjustment of the level is available in step of 1 % from 0 (alarm disabled) to 99 %.
- RFL Selection of the alarm activation level in case of reflected power lack expressed in percentage. The adjustment of the level is available in step of 1 % from 0 (alarm disabled) to 99 %.
- Audio Selection of the alarm activation level in case of audio lack expressed in percentage. The adjustment of the level is available in step of 1 % from 0 (alarm disabled) to 99 %.
- Mains Selection of the alarm activation time in case of mains power lack expressed in seconds. The adjustment of the value is available step of 1 s from 0 to 240 s.
- ExtFWD Selection of the alarm activation level in case of external forward power lack expressed in percentage. The adjustment of the level is available in step of 1 % from 0 (alarm disabled) to 99 %.
- ExtRFL Selection of the alarm activation level in case of external reflected power lack expressed in percentage. The adjustment of the level is available in step of 1 % from 0 (alarm disabled) to 99 %.
- s Selection of the alarm activation time, referred to the several entries, expressed in seconds. The adjustment of the value is available in step of 1 s from 0 to 240 s.

In the following is shown the operating logic of an alarm:

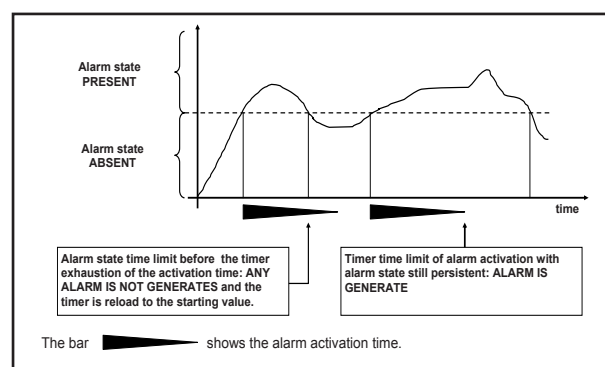

6.3.3.12 Alarms rescuer submenu (Aresc)

This menu provides the alarm rescuer of the exciter.

```

| |Status:Disable | |
| |AnaLev:-00 dBr| |
| |DigLev:-00 dBr| |
| |MpxLev:-00 dBr| |
| |PilLev:-00 dBr| |
| |CngTmr:000s 000s | |
| |RecTmr:000m 000m | |
| |Admin---[Exit]---| |

```

Figure 6.28

Status	Visualization of the alarm rescuer status. The status can be displayed OK (correct function), WARNING (the audio reserve is not available), FAULT (only MPX signal is present) or Disable (function disabled).
AnaLev	Selection of the analogic threshold level adjustment expressed in decibel (dBr). The adjustment of the level is available in step of 0.2 dBr from -18 to 0 dBr.
Diglev	Selection of the digital threshold level adjustment expressed in decibel (dBr). The adjustment of the level is available in step of 0.2 dBr from -18 to 0 dBr.
MPXlev	Selection of the composite threshold level adjustment expressed in decibel (dBr). The adjustment of the level is available in step of 0.2 dBr from -18 to 0 dBr.
PILlev	Selection of the pilot tone threshold level adjustment expressed in decibel (dBr). The adjustment of the level is available in step of 0.2 dBr from -18 to 0 dBr.
CngTmr	Selection of the intervention times for the passing with lower priority expressed in seconds. The adjustment of the level is available in step of 1 s from 5 to 200 s. In --- position the parameter is disabled.
RecTmr	Selection the intervention times for the passing with upper priority expressed in seconds. The adjustment of the level is available in step of 1 s from 5 to 200 s. In --- position the parameter is disabled.

6.3.3.13 General setting submenu (GnSet)

This menu provides the general setting (as modem, serial interface, time, etc.) of the exciter.

```

| |Uart  : 1      | | |
| |Baud  : 9600  | |
| |Modem :Absent | |
| |      |      | |
| |Lang. :English| |
| |Date  :00/00/00| |
| |Time  :00:00:00| |
| |Admin---[Exit]---| |

```

Figure 6.29

Uart	Selection of the address for I ² C and serial communications, selectable from 1 to 200.
Baud	Selection of the baud rate for the serial port data transfer, selectable between 1200, 2400, 4800, 9600, 19200 and 38400.
Modem	Selection of the modem modality. The status can be displayed “Present” (traditional PSTN modem function enabled), “GSM” (GSM modem function enabled) or “Absent” (modem function disabled).
Lang	Selection of the menu language.
Date	Selection of the date expressed as dd/MM/yy.
Time	Selection of the time expressed as HH:mm:ss.

6.4 Set up Reset

To reset completely the **PTX-DDS** to the factory set up, if necessary, follow the next instructions.

The user must hold pressed the encoder, therefore switch on the **PTX-DDS**, it will be displayed the following screen:

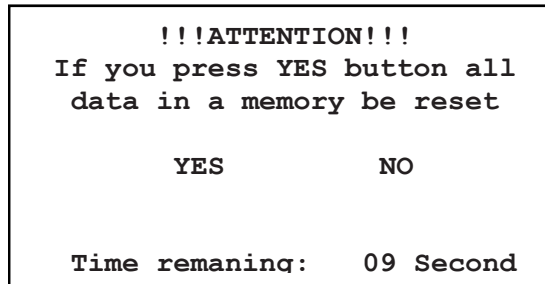

Figure 6.30

In order to make the reset, it is necessary to move the encoder until the “YES” label is highlighted, therefore press it. By pressing the encoder on the “NO” label the user is brought back to the normal start up (see chap.7.2).

In any case after 20 seconds, without selection, the user is brought back to the start up screen.

After you had pressed the “YES” label, when it is highlighted, will be displayed a new screen with the percentage information of restoring operation.

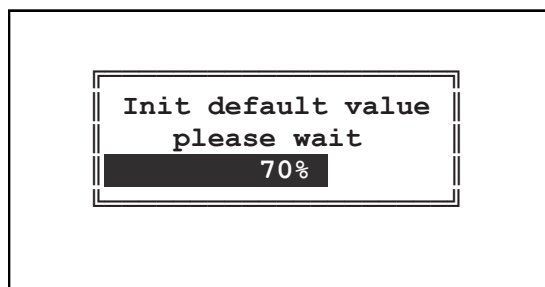

Figure 6.31

6.5 Audio Rescuer

6.5.1 Preliminary Considerations

The TRDSP card has available an Optical-AES/EBU digital input, two balanced analog inputs (audio channel left and right) for stereo broadcast, unbalanced MPX input scanned up to 100 kHz and 2 SCA adjustable inputs mixed in analogic with MPX input.

For automatic switching are considered three points:

- Signal level on analog audio input (L.A.). The reference threshold is calculated independently on left and right input as the value is relative to the input level set. The threshold refers to reading, so first of all audio processing such as PB, Preemphasis, Clipper, ITU or A.G.C.. The input signal is considered valid if both channels are valid. When you set the analogic CODER as MONO_L the level of the right channel is always considered valid.
- Signal level on digital audio AES/EBU, after conversion, independently the optical or balanced source (L.D.). The reference threshold is calculated independently on left and right input as the value is relative to the input level set. The threshold refers to reading, so first of all audio processing such as PB, Preemphasis, Clipper, ITU or A.G.C.. The input signal is considered valid if both channels are valid. When you set the digital CODER as MONO_L the level of the right channel is always considered valid.
- Signal level on MPX input, which contains the analogic sum of the three MPX, SCA1 and SCA2 unbalanced inputs. When this input is primary or secondary, the SCA inputs are automatically blocked to prevent measurements from the SCA (L.X.). The reference threshold is calculated in relative mode referred to the setted input level.
- Digital stream. It is found the consistency and validity of the digital texture by reading the FLAG status of the audio device (T.D.). To establish the validity of the texture are measured also the break for minute, which must be less than the parameter set by the user.
- 19KHz Tone. The presence of 19KHz pilot tone is continuously monitored on MPX input (T.P.). When you set the MPX CODER as MONO, the pilot tone is excluded from the aid algorithm.

6.5.2 Validity of signal sources

The following table defines the validity of sources in different configurations.

	Analogic Audio level	Digital Audio Level	MPX Audio Level	Digital Stream	Pilot Tone Plot
STEREO Analogic	R & L	----	----	----	----
MONO L Analogic	L	----	----	----	----
MONO L+R Analogic	R & L	----	----	----	----
STEREO Digital	----	R & L	----	----	----
MONO L Digital	----	L	----	----	----
MONO L + R Digital	----	R & L	----	----	----
STEREO + PLOT Digital	----	R & L	----	STREAM ERROR	----
MONO L + PLOT Digital	----	L	----	STREAM ERROR	----
MONO L + R + PLOT Digital	----	R & L	----	STREAM ERROR	----
Digital (0dB threshold)	----	PLL-LOCK	----	----	----
Digital (0dB threshold)	----	PLL-LOCK	----	STREAM ERROR	----
MPX – MONO	----	----	MPX	----	----
MPX – STEREO	----	----	MPX	----	19K TONE

6.5.3 Selections of sources via MIXER parameter

The following table that sorts the sources depending on the MIXER setting; from the table is possible to learn when they can use SCA inputs and what kind of emergency signals are controlled.

	Digital	Analogic	MPX	SCA 1 & 2
0	Not used	1°	Not used	Utilizables
1	1°	Not used	Not used	Utilizables
2	Not used	Not used	1°	Utilizables
3	1°	2°	3°	Utilizables
4	2°	1°	3°	Utilizables
5	1°	3°	2°	Not utilizables
6	3°	1°	2°	Not utilizables
7	2°	3°	1°	Not utilizables
8	3°	2°	1°	Not utilizables
9	1°	2°	Not used	Utilizables
10	2°	1°	Not used	Utilizables
11	1°	Not used	2°	Not utilizables
12	Not used	1°	2°	Not utilizables
13	2°	Not used	1°	Not utilizables
14	Not used	2°	1°	Not utilizables

For further information see Board setting submenu (BdSet).

6.5.4 Operation of rescuer

First of all, select the audio input modality or the automatic rescuer activation through Board setting submenu (BdSet).

	State 1	State 2	State 3
Mode 1	A (analogic)	-	-
Mode 2	-	D (digital)	-
Mode 3	-	-	X (MPX)
Mode 4	A (analogic)	D (digital)	X (MPX)
Mode 5	A (analogic)	X (MPX)	D (digital)
Mode 6	D (digital)	A (analogic)	X (MPX)
Mode 7	D (digital)	X (MPX)	A (analogic)
Mode 8	X (MPX)	A (analogic)	D (digital)
Mode 9	X (MPX)	D (digital)	A (analogic)

Then select the level, below which the rescuer enter in action, through Alarms rescuer submenu (Aresc).

When the rescuer enter in action or exit from alarm condition, the switching between inputs takes place according to the timetable set in the Alarms rescuer submenu (Aresc).

Alarm occurred: time from state 1 to 2 , and from state 2 to 3 is adjustable under CngTmr in the Alarms rescuer submenu (Aresc).

No alarm occurred: time from state 2 to 1 , and from state 3 to 2 is adjustable under RecTmr in the Alarms rescuer submenu (Aresc).

A brief graphic description of rescuer's operation is given here below:

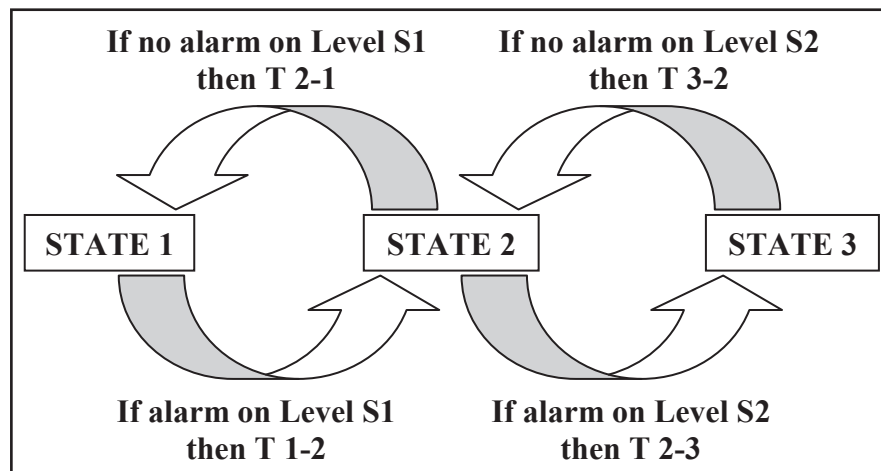

6.6 I.T.U.

The I.T.U. function is active only when the internal coder works, it has been implemented to monitor the output of complete MPX process. When you enable this function, the AGC is automatically switched off and the CLIPPER R & L function is added.

The I.T.U. function does not gain on input signal, but it is able to attenuate the input level until to 20dB.

In the intervention are included all the components present in the output like AUDIO, CARRIER, RDS and SCA. The corrective action is only on audio inputs, then the contribution of RDS and SCA will be offset by lowering the audio input.

You can change the ITU control reference respect to 0 of legislation in steps of 0.1dBr in the interval between 0dBr and 6dBr, this to adapt the legislation present in the different countries.

6.7 A.G.C. and Clipper

6.7.1 A.G.C. function for Analogic and Digital audio channel

The A.G.C. function (*Automatic Gain Control*) control in feedback the input level at the end of audio processing (Low Pass, Preemphasis, etc..) and needs to keep the audio signal at 0dBu level, avoiding to have signals continuously low or that continuously takes up the CLIPPER. The control is set with an absolute level (i.e.: 4dB), which indicates how many it can gain or attenuate this check.

The value range is adjustable from 0dB to 12dB, obviously the value of 0dB exclude the control while using 12dB completely uses completely the control.

The A.G.C. can be activated in 3 modes (Slow, Medium, Fast) and represents the speed at which very high signals are attenuated or very low audio signal are gained.

The contents of audio signal is not altered by this control, but it is only altered in amplitude.

This control works properly when accompanied by CLIPPER-ON function, which blocks the signal waiting of A.G.C. application.

6.7.2 A.G.C. function for MPX channel

The A.G.C. of MPX input works in identical mode to audio input but with a value range up to 6dB.

This control alters the level of SCA inputs of the same amount needed to correct the signal present on MPX. Furthermore, the control occurs on the sum of MPX and SCA.

6.7.3 Clipper function

The CLIPPER function cuts all signals above 0dB.

The Clipper on audio inputs is filtered to avoid compromising on pilot tone, RDS signal, and any SCA.

The Clipper on MPX input is for security, it cuts the signals in surplus but does not give any protection on pilot tone, RDS and SCA. The distortion of clipper is still contained within the 100 KHz of bandwidth allocated to this input.

7. Modules Identification

The **PTX-DDS** is made up of various modules linked to each other through connectors so as to make maintenance and any required module replacement easier.

7.1 Top View

The figure below shows the equipment top view with the various component pointed out.

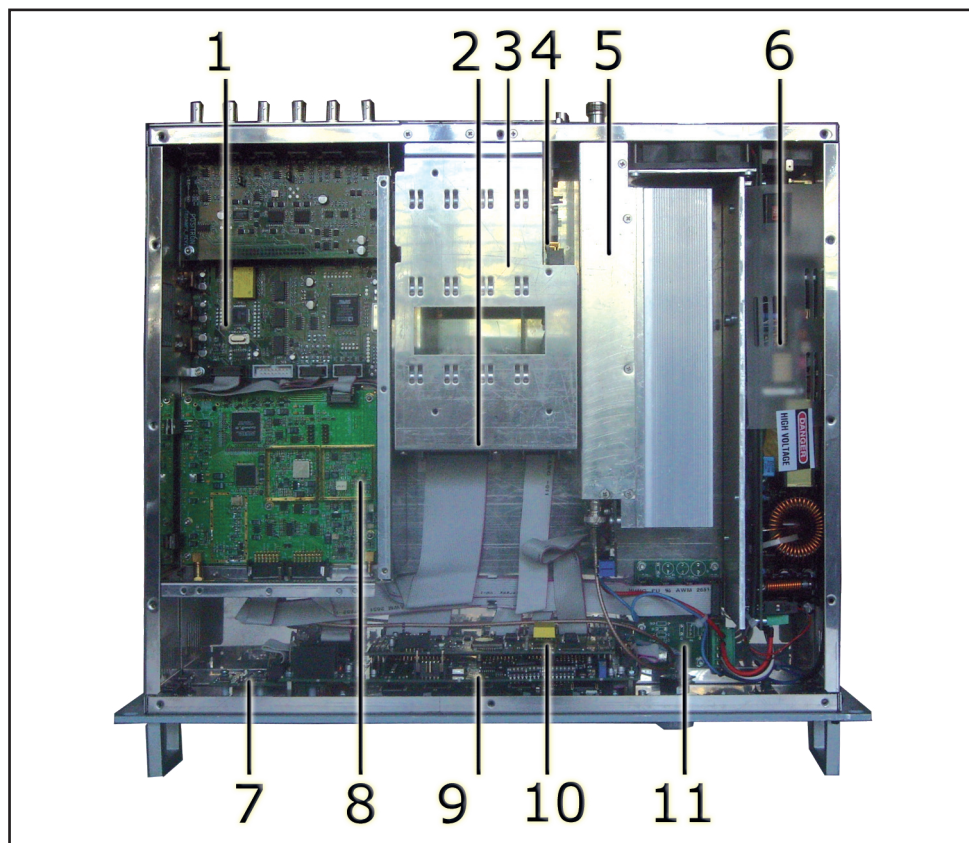
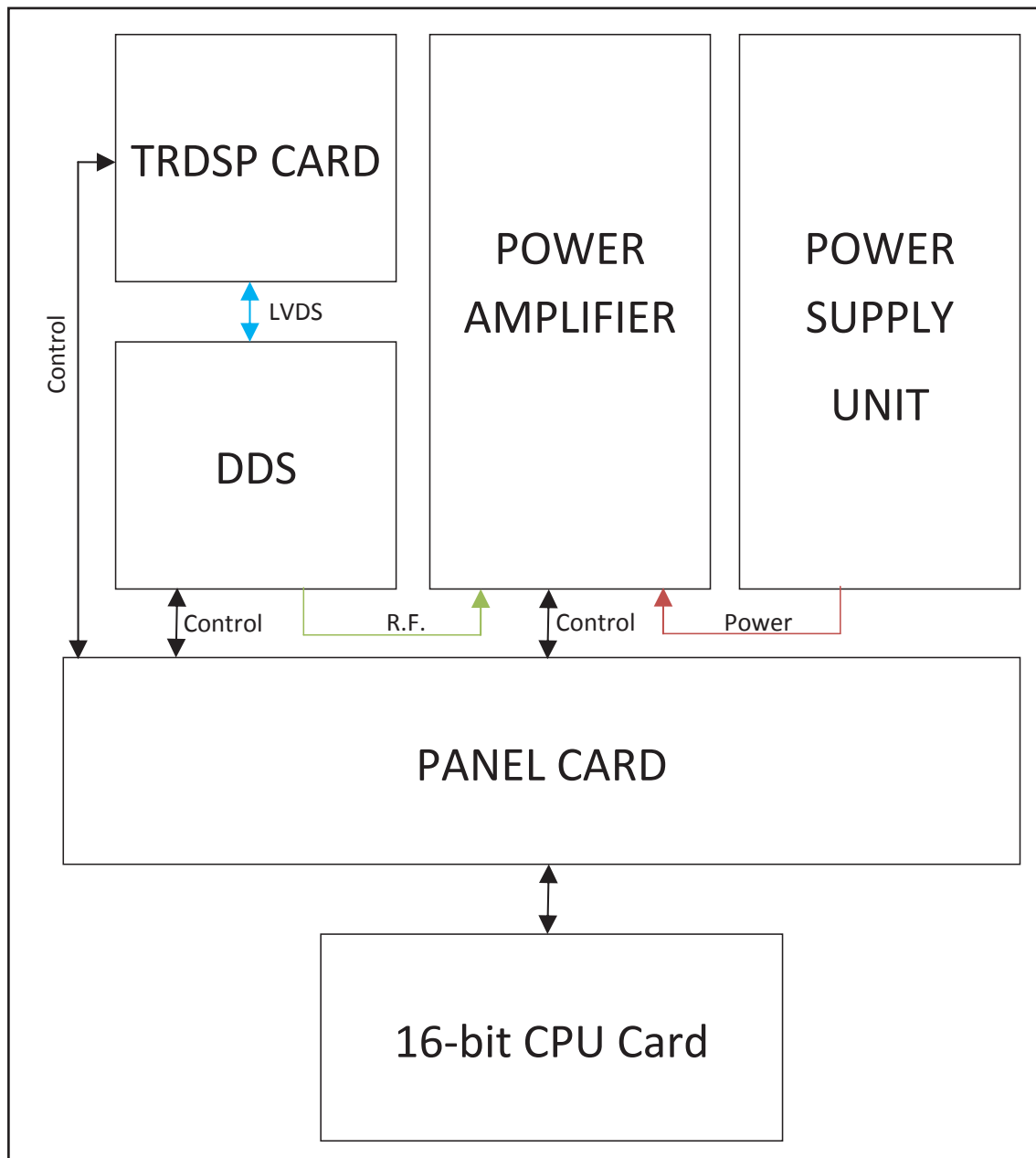

Figure 7.1

- [1] TRDSP board
- [2] TLM panel distribution card
- [3] RS232 card
- [4] Remote interface card
- [5] Power amplifier and RF control card (30W, 100W or 150W version)
- [6] Power supply card (28V 10A)
- [7] USB connector card
- [8] FM modulator card
- [9] Panel card
- [10] 16-bit CPU card
- [11] Power supply distribution card

7.1.1 Functional block diagram



7.2 Power supply unit

The **PTX-DDS** power supply unit is a switching-type unit whose VPA main output powers the machine's RF amplifier. The power supply also features stabilizers for generating continuous +7 V, +18V, -18V and +24 V voltages for powering the other device circuits.

7.3 Power amplifier

The power amplifier is available in a 30W, 100W and 150W version.

The final power stage is enclosed in a fully shielded metal container fixed to the central part of the device.

The RF signal coming from the main board reached the pilot, is amplified and then sent to the final stage which takes care of final amplification up to 30, 100 or 150W (depending the model).

Besides actual RF amplification, this circuit performs other functions:

- Checks output power level depending on the setting
- Reduces delivered power in presence of high-level reflected power
- Measures direct and reflected power by means of directional couplers
- Measures the current absorbed by the power amplifier
- Measures temperature
- Filters the pass low of the output RF signal

This board also features an RF sampling, which is available on a BNC connector below the transmitter output connector. Sampling is useful for verifying the characteristics of the carrier, but not for checking those of the upper harmonics.

7.4 Panel Card

This card is located in the front end of the device and provides an interface between the CPU card and the remaining **PTX-DDS** cards.

This card handles all signals from/to LCD, Encoder, LED Indicators, Power Supply Card, Audio Mainboard and external telemetry card, in other words, all input/output signals of the CPU card.

The software denotes jumper positions.

7.5 16-bit CPU Card

The CPU card is located at the front end of the device and is secured to the panel card.

This card is the heart of the transmitter as it handles and processes all information provided by the other cards and by other devices connected through the serial interface or the telemetry card.

The 1Mb Flash Memory enables firmware update through direct connection of **PTX-DDS** RS232 output to the serial port of a PC.

7.6 FM modulator Card

The FM modulator card is the real RF FM digital modulator DDS (Direct Digital Synthesizer) direct on channel.

This card receive the base-band signal in digital LVDS format from the TRDSP card. The base-band signal can be Mono, if stereo coder is disabled, MPX if stereo coder is enabled, plus RDS subcarrier (57 kHz) if enabled. The modulation card is

based on Altera FPGA device and create directly the modulated FM signal and a high performance DAC converter, capable to giving the final RF signal directly on the set FM working frequency. After the DAC there is a low-pass filter to eliminate the typical harmonic products after the DAC.

The RF output signal of the modulator card supplies the following power amplifier card.

The modulator card has an internal oscillator at 972 MHz (Internal VCO) that with a PLL give a very stable clock for the FPGA device and the DAC. The reference 10 MHz for the RF carrier is guaranteed by an internal 10 MHz oscillator (TCXO) or an external 10 MHz reference and the detection of external reference is automatic (Internal switchover). No manual adjusting point are present on this card.

7.7 TRDSP Card

The TRDSP is a DSP-based digital circuit that performs the following tasks:

- input selection, level adjustment and processing (filtering and preemphasis)
- stereophonic coding
- RDS (Radio Data System) signal generation.

The TRDSP accepts audio inputs in digital form (AES/EBU) or Left and Right analogue inputs that are immediately converted into digital format (A/D). A digital input is automatically selected when present, but analogue input selection can be forced with the appropriate software settings.

The MPX stereophonic signal “ (“Main”, “Sub” and 19 kHz subcarrier) is generated directly in digital form, starting with the Left and Right digital (or digitalised) channels.

The RDS is generated directly by DSP and then digitally added to the stereophonic audio signal. The messages transmitted by the RDS coder are programmed using a PC software supplied with the machine. It also possible to disable the internal RDS coder and use an external coder.

The TRDSP includes a support panel with the input and output connectors.

The key advantage offered by the TRDSP option is enhanced performance in terms of:

- Amplitude/frequency response (± 0.01 dB, 30 Hz - 15 kHz)
- Stereophonic separation (65 dB, 30 Hz - 15 kHz)
- Distortion ($< 0.03\%$)

In addition, the digitally processed signal enables frequency deviation limitation while avoiding the distortion issues typically experienced with analogue clippers.

At TRDSP output, the total signal (MPX + RDS) is converted into analogue form (D/A) and passed on to the modulation card section of **PTX-DDS**.

7.7.1 Audio Technical Specification

Parameter		TRDSP6 Value
ANALOGIC AUDIO INPUTS		
Unbalanced MPX Input	Connector	BNC (5 Kohm)
	Input Level	Adjustable from -12,5 to +12,5dBu in steps of 0,1dB
	Bandwidth	10Hz – 100KHz +/-0,02dB THD+N (BW=120KHZ) 0,004%
	ADC	24 Bit Sampling 380KHz
Unbalanced SCA Inputs	Connector	BNC (5 Kohm)
	Input Level	Adjustable from -30 to +13dBu in steps of 0,5dB
	Bandwidth	10Hz – 100KHz +/-0,02dB THD+N (BW=120KHZ) 0,004%
	ADC	24 Bit Sampling 380KHz
Balanced L&R Inputs	Connector	XLR (10 Kohm / 600 ohm)
	Input Level	Adjustable from -12,5 to +12,5dBu in steps of 0,1dB
	Preemphasis	0 / 50uS / 75uS
	LPF bandwidth On	10 Hz – 15KHz _ Ripple +/-0,06dB THD+N (BW=22KHZ)0,003%
	Low-pass filter	Pass-band 15KHz _ Stop-band -94dB a 17,4KHz
DIGITAL AUDIO INPUTS		
Balanced Input	Connector	XLR (75 – 110 ohm)
Optical Input	Connector	Tos-link
	Data Format	AES/EBU – S/PDIF – EIAJ 340 From 32 to 192KHz
	Input Level	Adjustable -30 to 0dBfs in steps of 0,1dB
ANALOGIC AUDIO OUTPUTS		
Pilot & Monitor Outputs	Connector	BNC (50 Ohm)
	Maximum Output Level	+12/+22dBu 24 Bit Sampling 190KHz
	Available Signal	Monitor, eco DDS – Pilote tone 19KHz
CODER STEREO		
Pilote Tone		19KHz +/- 0,2Hz
Pilote Tone level		Adjustable from -7,5 to -32,5 dBu in steps of 0,1 dBu
Pilote Tone phase		+/- 12,5° adjustable in steps of 0.1°
Pilot Tone THD+N		0,035% (BW 80KHz)
Attenuation at 38KHz		-92dB min.
Stereo Separation		75dB Typical - 70dB min. from 30Hz to 15 KHz
M/S – S/M		>80dB
Noise at Output		-94 dBu (BW 80KHz)
LIMITER, AGC, ITU		
Predictive Limiter level		Adjustable +/- 12dBu in steps of 0,1dB
MPX Clipper level		Adjustable +/- 6dBu in steps of 0,1dB
AGC R&L	Low – Middle – Slow	Adjustable +/- 12 dB in steps of 0,1dB
AGC MPX	Low – Middle – Slow	Adjustable +/- 6 dB in steps of 0,1dB
ITU level		Adjustable from 0 to +6 dB
PORTS		
Serial Ports (RDS COM1 RDS COM2)	Connector	DB9 (from 1200 to 115200 bps)
	Transmission Format	8 bit – no parity – 1 stop bit
Remote Port	Connector	DB9 (Activation TA, TP, MS)
RDS		
Signal	Specific	Cenelec EN50067
	Bandwidth	+/-2 ,4 KHz (-50dB)
	1&2 Ouput level	Adjustable from 0 to 2.200mVpp
	RDS/Pilot Phase	Adjustable from 0 to 360° in steps of 0.33°
Service	Compatibility	UECP – SPB490 Ver.6.1 / 2003
	Service	PTY, PTYN, TA, TP, MS, DI, PI, PS, AF, PIN, EON, RT, TDC, TMC, EWS, IH, CT
	DSN	N° 6 Manageable in time
	PSN	N° 1 PSN Main + N° 7 PSN – EON for each DSN
	PS (custom)	N° 8 messages up to 16 words in timed blocks or up to 128 sliding characters.
	AF	N° 100 lists of 25 frequencies for each main PSN
	RT	N° 16 for each DSN
	EON	N° 100 AF
	IH,TDC,TMC	N° 1 Buffer UECP, N° 1 Buffer FFG, N° 1 Buffer ODA (MEC42 , MEC45)
	EWS	N° 1 Buffer UECP, N° 1 Buffer FFG
PROCESSING		
A/D Conversion Input for L&R		24 bit (dynamic range 112dB)
A/D Conversion Input for SCA		24 bit (dynamic range 109dB)
D/A Conversion		24 bit (dynamic range 123dB)
DSP Processing		N°2 a 32-bit floating point with dual ALU - 200MHz

This page was intentionally left blank



R.V.R. Elettronica S.p.A.

Via del Fonditore, 2 / 2c

Zona Industriale Roveri · 40138 Bologna · Italy

Phone: +39 051 6010506 · Fax: +39 051 6011104

e-mail: info@rvr.it · web: <http://www.rvr.it>

ISO 9001:2000 certified since 2000



The RVR Logo, and others referenced RVR products and services are trademarks of RVR Elettronica S.p.A. in Italy, other countries or both. RVR ® 1998 all rights reserved.
All other trademarks, trade names or logos used are property of their respective owners.