

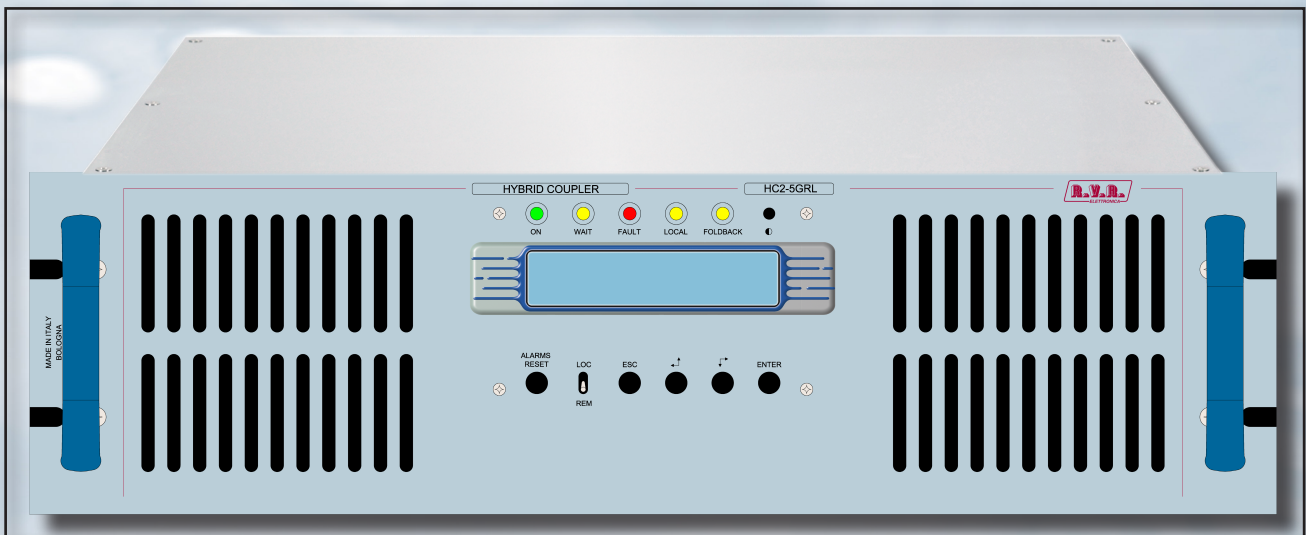

# HC2-5GRL

USER MANUAL  
VOLUME 1



**File Name:** HC2-5GRL\_ITA\_1.0.indb

**Version:** 1.0

**Date:** 29/11/2019

### Version History

Date	Version	Reason	Editor
29/11/2019	1.0	First edition	J. H. Berti

HC2-5GRL - User Manual  
Version 1.0

© Copyright 2019  
R.V.R. Elettronica  
Via del Fonditore 2/2c - 40138 - Bologna (Italy)  
Phone: +39 051 6010506  
Fax: +39 051 6011104  
Email: info@rvr.it  
Web: www.rvr.it

All rights reserved.

Printed in Italy. No part of this manual may be reproduced, memorized or transmitted in any form or by any means, electronic or mechanic, including photocopying, recording or by any information storage and retrieval system, without written permission of the copyright owner.

#### **Notification of intended purpose and limitations of product use**

This product is a FM transmitter intended for FM audio broadcasting. It utilizes operating frequencies not harmonised in the intended countries of use. The user must obtain a license before using the product in intended country of use. Ensure respective country licensing requirements are complied with. Limitations of use can apply in respect of operating frequency, transmitter power and/or channel spacing.

#### **Declaration of Conformity**

Hereby, R.V.R. Elettronica, declares that this FM transmitter is in compliance with the essential requirements and other relevant provisions of Directive 2014/53/EU.



# Technical Specifications

		HC2-5GRL		
Parameters		U.M.	Value	Notes
<b>GENERALS</b>				
Frequency range		MHz	87.5 ± 108	
Rated output power		W	5000	Continuously variable by software from 0 to maximum
Unbalanced Power Limit		W	1350	
Ambient working temperature		°C	-5 to + 50	
Ambient Working Humidity		%	85 (Without condensing)	
<b>INPUTS</b>				
Power Splitter	Connector		N-Type	
	Impedance	Ohm	50	
	Power	W	150	
Power Coupler	Connector		7/8" EIA	
	Impedance	Ohm	50	
	Number of Way		2	
	Power	W	2500	
<b>OUTPUTS</b>				
Power Coupler	Connector		7/8" EIA	
	Impedance	Ohm	50	
Power Splitter	Connector		N-Type	
	Impedance	Ohm	50	
	Number of Way		2	
<b>POWER REQUIREMENTS</b>				
AC Power Input	AC Supply Voltage	VAC	117 ± 230 +10% -15%	
	AC Apparent Power Consumption	VA	61	
	Active Power Consumption	W	61	
	Power Factor		0,998	
	Connector		VDE IEC Standard	
DC Power Input	DC Supply Voltage	VDC	--	
	DC Current	ADC	--	(*)max 25W (**) max 140W
<b>MECHANICAL DIMENSIONS</b>				
Physical Dimensions	Front panel width	mm	483 (19")	19" EIA rack
	Front panel height	mm	132 (3HE)	
	Overall depth	mm	573	
	Chassis depth	mm	501	
Weight		kg	about 16	
<b>VARIOUS</b>				
Cooling			Forced, with internal fan	
Acoustic Noise		dBa	<75	
<b>AUXILIARY CONNECTIONS</b>				
Interlock	Connector		BNC	For remote power inhibition (short is RF off)
Foldback	Connector		BNC	
RS232	Connector		DB9 F	
I2C bus	Connector		DB9 F	
Telemetry Interface	Connector		DB25F	
Common Bus	Connector		DB15M	
<b>FUSES</b>				
On Mains			1x External F 3,15 - 5 x 20 mm	

# Table of Contents

<b>1. Preliminary Instructions</b>	<b>1</b>
<b>2. Warranty</b>	<b>1</b>
<b>3. First aid</b>	<b>2</b>
3.1 Treatment of electric shocks	2
3.2 Treatment of electrical burns	2
<b>4. General description</b>	<b>3</b>
4.1 Unpacking	3
4.2 Features	3
4.3 Description of the Front Panel	5
4.4 Description of the Rear Panel	6
4.5 Description of the Connectors	7
<b>5. Installation and Configuration Procedure</b>	<b>9</b>
5.1 Installation	10
5.2 Software	17
<b>6. Identification and Access to the Modules</b>	<b>26</b>
6.1 Identification of the Modules	26
6.2 Spare Parts List	27
<b>7. Principles of Operation</b>	<b>28</b>
7.2 Description of the modules	28
7.2 Compensation	30
<b>8. Maintenance and Repair Procedures</b>	<b>32</b>
8.1 Introduction	32
8.2 Safety Considerations	32
8.3 Ordinary maintenance	32
8.4 Replacing the Modules	34



**IMPORTANT**

The lightning bolt symbol inside a triangle on the product draws attention to operations for which care must be taken to avoid the danger of electric shock.



The exclamation point symbol inside a triangle on the product informs the user of the presence of instructions in the manual accompanying the equipment, which are important for operation and maintenance (repairs).

## 1. Preliminary Instructions

### • General Notices

The equipment in question is to be considered for use, installation and maintenance by “trained” or “qualified” personnel aware of the risks associated with working on electrical and electronic circuits.

The definition of “trained” means personnel with the technical knowledge required to use the device in a manner that ensures their own safety and that of other unqualified personnel under their direct supervision when working on the equipment.

The definition of “qualified” means personnel with the training and experience required to use the device in a manner that ensures their own safety and that of other unqualified personnel under their direct supervision when working on the equipment.

 **CAUTION:** The device may be equipped with an **ON/OFF switch which may not completely remove voltage inside the device. It is necessary to disconnect the power cord, or turn off the power panel, before carrying out technical work, making sure that the safety earth connection is connected.**

**Technical work that involves inspection of the device with live circuits must be carried out by trained and qualified personnel in the presence of a second trained person who is ready to intervene by disconnecting the power supply in case of need.**

**R.V.R. Elettronica** assumes no responsibility for injury or damage caused by improper or incorrect use by personnel, whether trained and qualified or not.

 **CAUTION:** The device is not resistant to the ingress of water and infiltration could seriously compromise its correct performance. To prevent fire or electric shock, do not expose this equipment to rain, infiltration or moisture.

Please observe local regulations and fire regulations when installing and using this equipment.

 **CAUTION:** The device in question has internal parts that pose the risk of electric shock: always disconnect the power supply before removing the covers or any other part of the equipment.

Ventilation slots and holes are provided to ensure reliable operation of the product and to protect it from overheating. These slots must not be obstructed or covered. The slots must not be obstructed under any circumstances. The product should not be incorporated into a rack unless it is provided with adequate ventilation or the manufacturer's instructions have been followed.

 **CAUTION:** This equipment can radiate radio frequency energy, and if not installed in accordance with the instructions in the manual and the regulations in force it can interfere with radio communications.

 **CAUTION:** This equipment has an earth connection on both the power cord and the chassis. Make sure they are connected correctly.

Operating this appliance in a residential environment can cause radio disturbances; in this case, the user may be required to take appropriate measures.

The specifications and information given in this manual are provided for informational purposes only, and may therefore be subject to change at any time without notice and should not be seen as binding to **R.V.R. Elettronica**.

**R.V.R. Elettronica** assumes no responsibility or liability for any errors or inaccuracies that may appear in this manual, including the products and software described in it; and reserves the right to make changes to the design and/or technical specifications of the equipment, as well as to this manual, without prior notice.

• **Notice regarding the intended use and limitations on use of the product.**

This product is a radio transmitter suitable for frequency modulated audio broadcasting service. It uses operating frequencies that are not harmonized in the designated user states.

The user of this product must obtain specific authorization for use of the radio spectrum from the spectrum management authority of the designated user state, before putting this equipment into operation.

The operating frequency, the power of the transmitter, as well as other characteristics of the transmission system, are subject to limitations and are set out in the authorization obtained.

## 2. Warranty

**R.V.R. Elettronica** guarantees the absence of manufacturing defects and the proper functioning of the products, within the terms and conditions provided.

Please read the terms carefully, because purchasing the product or accepting the order confirmation constitutes acceptance of the terms and conditions.

For the latest updates on the legal terms and conditions, please visit our website ([WWW.RVR.IT](http://WWW.RVR.IT)) which can also be modified, removed or updated for any reason without notice.

The warranty will be void in the event of opening the equipment, physical damage, misuse, modification, repair by unauthorized persons, carelessness and use for purposes other than those intended.

In the event of a defect, proceed as described below:

- 1 Contact the retailer or distributor from whom the equipment was purchased; describe the issue or malfunction to verify if there is a simple solution.

Retailers and Distributors are able to provide all information relating to the most common issues; they can usually repair the equipment much faster than the manufacturer could. Installation errors can normally be identified directly by retailers.

- 2 if your retailer cannot help you, contact **R.V.R. Elettronica** and describe the issue; if the staff deems it necessary, the authorization to send the equipment will be sent to you with the appropriate instructions;

- 3 Once you have received authorization, you can return the unit. Pack it carefully for shipping, preferably using the original packaging and duly sealing the package.

The customer always assumes the risks of loss (i.e., R.V.R. is never liable for damage or loss), until the package reaches the R.V.R. facility. For this reason, we suggest that you insure the goods for their full value. The goods must be shipped, using C.I.F. values (PAID IN ADVANCE), to the address specified by the R.V.R. service manager on the authorization.



The equipment must not be returned without the authorization for sending as it may be returned to the sender.

- 4 Make sure to include a descriptive technical report mentioning any issues encountered and a copy of your original invoice indicating the date from which the warranty is valid.

Spare parts and parts under warranty can be ordered at the following address. Make sure to include the model and serial number of the equipment, as well as the description and number of spare parts.



R.V.R. Elettronica  
Via del Fonditore, 2/2c  
40138 BOLOGNA ITALY  
Tel. +39 051 6010506

## 3. First aid

Personnel entrusted with installation, use, and maintenance of the equipment must be familiar with first aid theory and practices.

### 3.1 Treatment of electric shocks

#### 3.1.1 If the victim has lost consciousness

Follow the first aid principles below.

- Place the victim lying on their back on a hard surface.
- Open the airway by lifting the neck and pushing the forehead back (**Figure 1**).

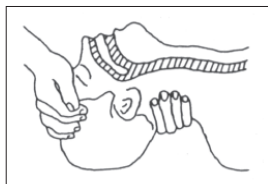

Figure 1

- If necessary, open their mouth and check their breathing.
- If the victim is not breathing, start artificial respiration immediately (**Figure 2**): tilt the head, close the nostrils, make your mouth adhere to that of the victim and perform 4 quick breaths.



Figure 2

- Check the heart rate (**Figure 3**); in the absence of a heartbeat, immediately begin heart massage (**Figure 4**) by compressing the sternum approximately in the centre of the chest (**Figure 5**).

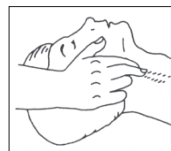

Figure 3

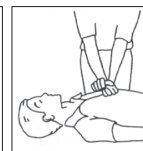

Figure 4

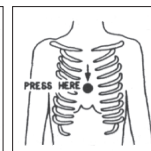

Figure 5

- In the case of only one rescuer, this person must maintain a rhythm of 15 compressions alternating with 2 quick breaths.
- In the case of two rescuers, the rhythm must be one breath every 5 compressions.
- Do not interrupt heart massage during artificial respiration.
- Call a doctor as soon as possible.

#### 3.1.2 If the victim is conscious

- Cover the victim with a blanket.
- Try to keep the victim calm.
- Loosen the clothes and place the victim in a lying position.
- Call a doctor as soon as possible.

### 3.2 Treatment of electrical burns

#### 3.2.1 Extensive burns and cuts to the skin

- Cover the affected area with a clean sheet or cloth.
- Don't break blisters; remove fabric and items of clothing adhering to the skin; apply a suitable ointment.
- Treat the victim as required for the type of injury.
- Transport the victim to the hospital as quickly as possible.
- If the arms and legs have been affected, keep them elevated.

If medical help is unavailable for an hour and the victim is conscious and not retching, administer a liquid solution of salt and baking soda: 1 teaspoon of salt and half a teaspoon of baking soda for every 250ml of water.

Slowly drink about half a glass of solution four times over a period of 15 minutes. Discontinue if retching occurs.

Do not give alcohol.

#### 3.2.2 Less serious burns

- Apply cold (not icy) gauze compresses using as clean a cloth as possible.
- Don't break blisters; remove fabric and items of clothing adhering to the skin; apply a suitable ointment.
- If necessary, put on clean and dry clothes.
- Treat the victim as required for the type of injury.
- Transport the victim to the hospital as quickly as possible.
- If the arms and legs have been affected, keep them elevated.

## 4. General description

The **HC2-5GRL**, manufactured by R.V.R. Elettronica, is a hybrid coupler made with “Strip-Lines” technology. Its function is to divide the RF signal coming from an exciter by appropriately regulating its relative phases, to supply them to two external power amplifiers and to combine the amplified outputs through a single antenna output. The **HC2-5GRL** combines transmitters of 2500 W max power (5 kW total).

The **HC2-5GRL** is designed to be contained in a 3HE 19” rack box.

### 4.1 Unpacking

The package contains the following:

- 1 **HC2-5GRL**
- 1 Compliance Documentation
- 1 Power connector

You can also obtain the following accessories for the equipment from your R.V.R. retailer:

- **Options for the equipment: /AUDIGIN-TFT, /RDS-TEX-2HE, /RDS-TEX-E-2HE and /TLW-TEX-E-2HE**

	<b>/LINEOUT-HCGRL</b>	<b>/EXT24V-HCGRL</b>
<b>/LINEOUT-HCGRL</b>		•
<b>/EXT24V-HCGRL</b>	•	

•: compatible option / o: option already included / x : not compatible option

*Table 4.1: table of compatibility of the various options*

- **Spare parts**
- **Cables**



### 4.2 Features

The nominal operation of a transmitter based on a hybrid combiner scheme such as the **HC2-5GRL** requires the amplifiers to deliver the same power. Any power differences (or phase shifts) between the amplifiers produce so-called “imbalance power”, which is partly dissipated inside the combiner. The **HC2-5GRL** guarantees operation of the transmitter even if one of the amplifiers is completely out of service. In which case, the power coming from the surviving amplifier is transmitted to the antenna, except for a fraction of it (about 1/4) which is dissipated inside the combiner.

The **HC2-5GRL** is controlled by a microprocessor system which includes an LCD display and a push-button panel for user interaction, and which performs the following functions:

- Measurement and display of the working parameters of the coupler
- Activation and deactivation of power delivery
- Protection of the coupler against potentially harmful situations such as power output, imbalance power, driving power or excessive temperature
- Detection of user-settable warning thresholds (e.g. power emitted below a certain threshold), which are made available as digital variables on the telemetry connector
- Communications with external devices

The management software of the **HC2-5GRL** is based on a menu system.

The user can navigate between the different submenus using four buttons: **ESC**, , , and **ENTER**. A fifth button is used to reset the alarm counter, if any alarms have occurred.

The status of the equipment is indicated by five LEDs on the front panel: **ON/OFF**, **WAIT**, **FAULT**, **LOCAL** and **FOLDBACK**.

At a switch located on the front panel, the coupler can be set to operate in **LOCAL** or **REMOTE** mode:

- the **LOCAL** mode allows commands to be entered using the buttons on the front panel and excludes remote control (i.e. via the telemetry connector);
- in **REMOTE** mode, the remote control is enabled, while with the buttons it is only possible to view the various parameters, but not to modify them.

**LOCAL** mode is indicated by lighting of the corresponding yellow LED on the front panel.

A telemetry connector on the back of the **HC2-5GRL** provides the measurements of the device in the form of analogue signals proportional to the values of the variables. On the same connector there are digital alarm and warning signals and digital inputs, for example on/off and alarm reset.

The hybrid coupler has an input for external 24Vdc power supply (optional).

This auxiliary power source is used automatically to keep the CPU section functional in the event of a power failure. In this way it is possible to interact with the device (locally or remotely) even in the event of a power failure.

The **HC2-5GRL** can be connected in cascade to the exciter via an interlock cable, so as to be able to deactivate the power delivery of the exciter in the event of malfunctions in the transmission system. A similar effect can be obtained even if the exciter does not have the interlock function, by connecting the power supply to the auxiliary power socket of the **HC2-5GRL** "AUX OUT AC LINE" (optional).

### 4.3 Description of the Front Panel

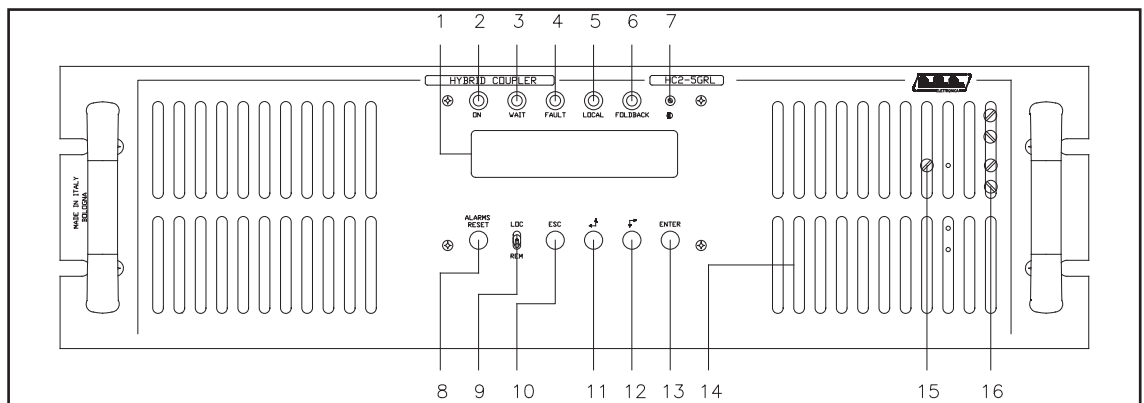

Figure 4.1

- |                 |  |
|-----------------|--|
| [1] DISPLAY     | Liquid crystal display.  |
| [2] ON          | Green LED, illuminated when the hybrid coupler is powered.   |
| [3] WAIT        | Yellow LED indicating that the hybrid coupler is waiting for a condition preventing power delivery to be eliminated.   |
| [4] FAULT       | Red LED indicating the presence of a malfunction that can no longer be solved automatically.   |
| [5] LOCAL       | Yellow LED, illuminated when the exciter is set to Local mode.   |
| [6] FOLDBACK    | Yellow LED, illuminated when the foldback function has been triggered (automatic reduction of power delivery if connected to the exciter that implements the function, as for example in PTX-LCD). |
| [7] BRIGHTNESS  | Display contrast adjustment trimmer.   |
| [8] ALARM RESET | Button for manual reset of the protection system.  |
| [9] LOC/REM     | Remote or local control mode selector.   |
| [10] ESC        | Button to be pressed to exit a menu.   |
| [11] ↶ ↷        | Button for navigating the menu system and for changing parameters.   |
| [12] ↵ ↲        | Button for navigating the menu system and for changing parameters.   |
| [13] ENTER      | Button for confirming a parameter and for entering the menus.  |
| [14] AIR FLOW   | Air intake for the combiner and divider circuit.   |
| [15] POWER ADJ. | Power adjustment trimmer   |
| [16] PHASE ADJ. | Phase adjustment of RF channels (Depends on hardware version).   |

## 4.4 Description of the Rear Panel

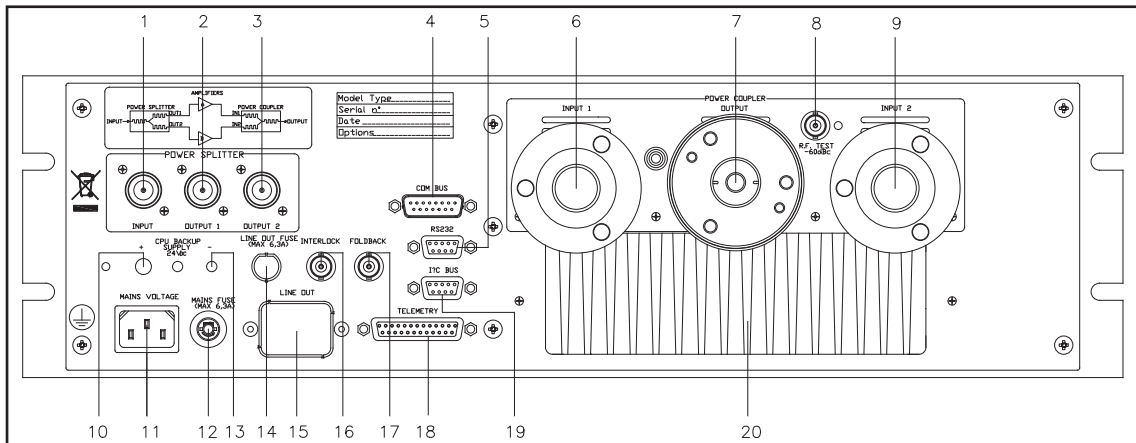

Figure 4.2

- |                    |   |
|--------------------|---|
| [1] INPUT          | Exciter input connector (N type connector).   |
| [2] OUTPUT 1       | Output 1 of the divider circuit (type N connector) to drive amplifier A.  |
| [3] OUTPUT 2       | Output 2 of the divider circuit (type N connector) to drive amplifier B.  |
| [4] COM BUS        | DB15 connector for interfacing with other devices   |
| [5] RS232          | DB9 connector for connecting the device to external devices.  |
| [6] INPUT 1        | Input 1 of the combiner circuit (7/8" EIA Flange) coming from amplifier A.  |
| [7] OUTPUT         | Output of the combiner circuit (7/8" EIA Flange).   |
| [8] R.F. TEST      | BNC RF monitor output. The output level is -60 dB below the output power in the 87.5-108 MHz band (to be used for monitoring the FM band only). |
| [9] INPUT 2        | Input 2 of the combiner circuit (7/8" EIA Flange) coming from amplifier B.  |
| [10] 24 Vdc IN +   | Connector for external 24 Vdc power supply for the emergency power supply of the CPU $\pm$ 250mA (optional). Positive (red).                    |
| [11] MAINS VOLTAGE | VDE socket for mains supply.  |
| [12] MAIN FUSE     | Protection fuse for the main AC output. Power Line.   |
| [13] 24 Vdc IN -   | Connector for external 24 Vdc power supply for the emergency power supply of the CPU $\pm$ 250mA (optional). Negative (black).                  |
| [14] LINE OUT FUSE | Protection fuse for the auxiliary AC output. Power Line (optional).   |
| [15] LINE OUT      | Auxiliary VDE power socket for powering external devices, typically an exciter (optional).  |
| [16] INTERLOCK     | BNC connector to disable an external device, such as an exciter. In case of faults, the central conductor is grounded.                          |
| [17] FOLDBACK      | BNC connector for "foldback".   |
| [18] TELEMETRY     | DB25 telemetry connector.   |
| [19] I2C           | DB9 connector for I2C standard connections.   |
| [20] HEAT SINK     | Heat sink.  |



## 4.5 Description of the Connectors

### 4.5.1 Remote

Type: DB25 female

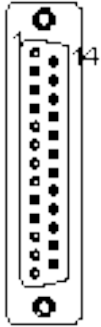

Pin	Name	Type	Meaning
1	Imbalance Power	Ana Out	3.9V x 1350 W
2	Ch_4	Disabled	
3	GND	GND	
4	Reflected Power	Ana Out	4.3V x 500 W
5	OC_ECC	Dig Out OC	Active in case of interlock
6	OC_SET4	Disabled	
7	GND	GND	
8	IN_ON	Dig In	"ON" command
9	OC_SET1	Dig Out OC	Active when SET1 threshold is exceeded
10	OC_WAIT	Dig Out OC	Active in case of "Wait" alarm
11	IN_RST	Dig In	"Reset alarms" command
12	OC_OFF	Dig Out OC	Active when OFF
13	IN_INH	Dig In	Maintain at GND to inhibit
14	TEMP	Ana Out	3.9V x 70°
15	Ch_5	Disabled	
16	Forward Power	Ana Out	4.3V x 5000 W
17	OC_FAULT	Dig Out OC	Active in case of "Fault" alarm
18	OC_SET3	Dig Out OC	Active when SET3 threshold is exceeded
19	Ch_3	Disabled	
20	IN_OFF	Dig In	"OFF" command
21	GND	GND	
22	OC_SET2	Dig Out OC	Active when SET2 threshold is exceeded
23	LOC	Dig Out.	
24	VNS	+12 Vdc	Not stabilized
25	OC_ON	Dig Out OC	Active when ON.

Note:

- To send a command to the **HC2-5GRL** (ON, OFF, Reset), ground the relative pin for about 500 ms
- OC (Open Collector) outputs are considered "Active" when conducting

### 4.5.2 RS232

Type: DB9 female

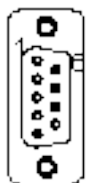

1	NC
2	TXD
3	RXD
4	Internally connected with 7 and 8
5	GND
6	NC
7	Internally connected with 4 and 8
8	Internally connected with 4 and 7
9	NC



### 4.5.3 I<sup>2</sup>C Connector

Type: DB9 female - Used for I<sup>2</sup>C connections

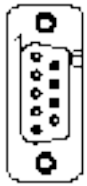

1	NC	
2	SDA	Serial DATA
3	SCL	Serial CLOCK
4	NC	
5	GND	GND
6	NC	
7	NC	
8	NC	
9	NC	

## 5. Installation and Configuration Procedure

Instructions are given in this chapter on installation and configuration of the equipment. Carefully perform all the steps described in this chapter both upon initial start-up and every time the main configuration is changed, for example when moving to a new transmission station or when replacing the equipment.



**IMPORTANT:** *always disconnect the mains power before carrying out any type of installation and/or maintenance. It is imperative to cut off the power supply to avoid electric shock hazards that could cause damage to property and physical harm, serious injuries or even death.*

The equipment must only be installed by qualified personnel.

Qualified personnel are personnel who comply with all the safety directives, laws and standards that apply to the installation and operation of this device.

The choice of qualified and duly trained personnel is always the responsibility of the employer, since the employer is always the one in the best position to judge whether a worker is suitable for a particular job and therefore capable of ensuring their safety while respecting the applicable law on occupational safety.

Employers must provide their personnel with adequate training in electrical devices, and ensure that they are familiar with the content of this manual.

Compliance with the safety instructions set out in this manual or with the legislation indicated does not relieve the personnel from the duty to also comply with other specific standards relating to the installation, place, country or other circumstances concerning the equipment.



**IMPORTANT:** *there is a danger of possible electric shocks and it is therefore mandatory to comply with the applicable safety law regarding electrical aspects.*

Once configured, the equipment is ready for normal operation and no further intervention is required since all the parameters are saved automatically for when the equipment is switched off and on again either intentionally or unintentionally.

The performance and functions of the hardware and firmware of the equipment are described in more detail in the following chapters: please refer to the relevant sections of the manual for further information on what is covered in this chapter.



**IMPORTANT:** *during all phases of configuration and testing of the transmitter of which this equipment forms part, always keep to hand the test table (“Final Test Table”) accompanying the equipment: this document covers all the operating parameters of the equipment set and checked at the time of testing after production.*

## 5.1 Installation

### 5.1.1 General Requirements

The ventilation of the equipment and workplace must be suitable for maintenance according to the directive in force in the country in which this equipment is installed.

To ensure correct operation of the appliance, there must be a clearance of at least 50 cm at the front and back of the device to facilitate the circulation of air through the ventilation grids.

In any case, the clearances must be in accordance with the safety directive in force in the country where this equipment is installed.

This device has been designed to operate at temperatures between -10 °C and 45 °C without loss of performance. The ambient air must be dust-free and not condensed; the maximum humidity must never exceed 95%.

In particular environmental conditions it should be remembered that temperature fluctuations can cause condensation. If the place where this device is located should be subject to these physical events, it is advisable to monitor the device once it is put into service, in addition to trying to protect the device itself as best as possible.



**IMPORTANT:** *never power up the equipment in the presence of condensation. This problem can occur more frequently in the case of equipment stored for a long time or used as active backup.*

The RF antenna, power supply and connection cables must have a section suitable for the maximum current intensity.

### 5.1.2 Preliminary checks

Unpack the appliance by removing the wrapping and, before any other operation, check for any damage due to transport. Carefully check that all connectors are in perfect condition and verify the absence of moisture. Otherwise, wait until it is completely dry.

If any issues occur during this first phase, contact the after-sales service immediately.

The main fuse is accessible from the outside on the rear panel. Remove the fuse block with a screwdriver to check its condition and replace it if necessary. The fuses to be used are:

	HC2-5GRL @ 230 Vac
Main fuse	(1x) F 3.15A type 5x20

Table 5.1: *Fuses*

### 5.1.3 Placement of the device

Useful tips for correct installation:

- Avoid the presence of external elements near the ventilation inlets and outlets, as they could prevent proper ventilation of the device.
- Avoid proximity to a source of heat or flammable gas.
- Limit places subject to accumulation of humidity, dust, sand or salt or environments that could compromise correct operation of the equipment.
- Avoid installing the equipment in inhabited places due to possible noise pollution, or on lightweight supports. The device may hum during operation due to forced ventilation. The mounting surface must be able to withstand the weight of the device and must be solid.



**Note:** below we will refer to a complete station of which the device can form a part. The same procedures also apply if the device is used as a standalone one.

The device is generally connected inside a 19" rack and fixed with M5 screws in the designated holes.

The device must be installed at least 1 metre from the ground.

Install the rack where the transmitter will be operated. The rack is mounted on wheels for ease of movement: once it is put into position it is advisable, therefore, to use the four screws at the base of the rack to stabilize it perpendicular to the ground.

The environment where the rack is installed should be air conditioned at about 25 °C and equipped with a filter for the elimination of dust and salt.



The station normally has an air outlet at the rear of the equipment: in which case, ensure adequate ventilation of the room.

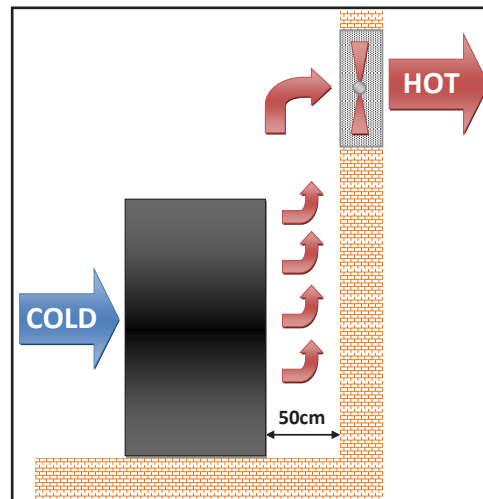

Alternatively it is cooled by forced ventilation and the air intake is located on the roof of the equipment. A hose approximately 1.5 metres in length is recommended.

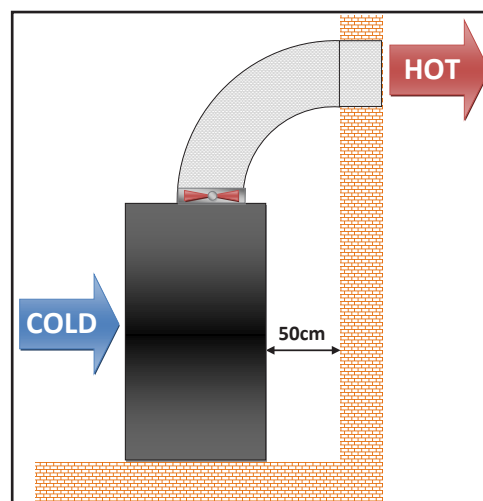

It is strongly recommended to install the rack at least 50 cm from the rear and side walls in order to allow optimal air flow and ease of maintenance.

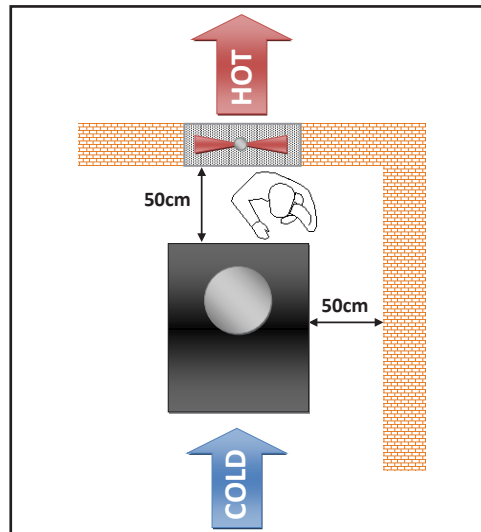

#### 5.1.4 Power supply connections of the device

Prepare the following connection (valid for both functional tests and final commissioning):

- √ Single-phase mains power connector, 230 (-15% / + 10%) Vac.  
A conductor section of at least 1.5 mm<sup>2</sup> is recommended.



**Note:** to ensure the safety of the operators, prepare the wiring according to the laws and regulations in the country where this equipment is installed.

Connect the mains cable to the MAINS socket on the rear panel.



Connecting the MAINS socket



**Caution:** To avoid the **risk of damaging the equipment**, it is essential that this is properly earthed. It is mandatory, therefore, to check the efficiency of the earth connection of your system.



**Note:** to ensure both the safety of the operators and correct operation of the equipment, it is essential that the mains system is earthed and properly connected to the equipment..

Useful tips for a correct connection:

- Prepare suitable earthing of the electrical system. This offers both direct protection, as it prevents shocks when direct contact is made with the metal casings of the equipment, and indirect protection, as it cuts off the supply of energy when dispersion occurs due to poor insulation. This can be done independently also with an earthing rod and inspection pit installed by the qualified personnel of a specialised company.
- Provide internal lightning protection such as a surge arrester (internal SPD) or a circuit breaker, to be installed by qualified personnel in the distribution panel. This solution allows to protect from violent atmospheric electric discharges that hit the surrounding ground up to several kilometres.
- Provide internal protection against disturbances on the distribution line such as EMI filters or line voltage stabilizers, to be installed by qualified personnel in the distribution panel, which can filter disturbances caused by electrical equipment and sudden surges on the line, as well as permit voltage control.

## 5.1.5 Signal and RF connections

Prepare the following connection (valid for both functional tests and final commissioning):

√ For functional tests only:

- a dummy load with 50 Ohm impedance and of appropriate power (minimum 5000W for **HC2-5GRL**).
- Coaxial cable with BNC connectors for connecting the **INTERLOCK** signal to the load protection.

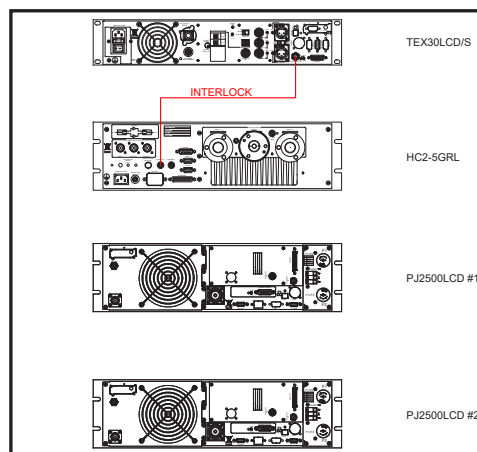

*INTERLOCK signal connection*



- Coaxial cable with BNC connectors for connecting the **COMMON BUS** signal.

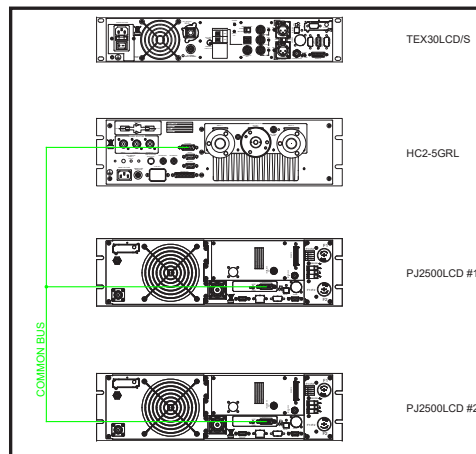

*COMMON BUS connection*

- √ Connection cable kit including:
  - RF cable for the output towards the load / antenna (50 Ohm coaxial cable with standard 7/8" type connector).
  - RF cables for amplifier input (2x 50 Ohm coaxial cables with standard 7/8" type connector).
  - RF cable for exciter input (50 Ohm coaxial cable with N type connector).
  - RF cables for output to amplifiers (2x 50 Ohm coaxial cable with N type connector).

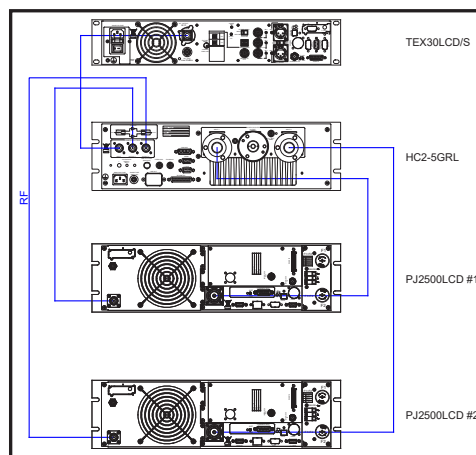

*RF signal connection*



**CAUTION:** risk of burns due to RF. Before connecting the antenna cable, make sure that the equipment cannot emit RF at the output.



**CAUTION:** For reasons of electromagnetic compatibility, only double shielded cables should be used at the RF output.

Connect the exciter RF output cable to the N-type input connector of the combiner's splitter section. Connect two cables between the N-type output connectors of the splitter section and the RF inputs of the two amplifiers. Connect two cables between the output connectors of the two amplifiers and the 7/8" EIA type inputs of the combiner's coupling section.

Connect the 7/8" EIA type output connector of the combiner section to the antenna or to a dummy load capable of dissipating the power involved. Connect with a coaxial cable one of the BNC **INTERLOCK** connectors to the **INTERLOCK** connector of the exciter (see the diagram included with each station for reference). Connect the **FOLDBACK** connector to the **EXT. A.G.C.** input of the exciter, if envisaged in the configuration (see station manual).

The hybrid combiner must be installed in a rack that includes an anti-tear device to prevent the possibility of accidentally disconnecting the power leads.



**CAUTION:** To avoid electric shocks and electrocution, never touch the RF output connector when the equipment is powered up and with no load connected.



**Note:** to ensure both the safety of the operators and correct operation of the equipment, it is essential that the mains system is earthed and properly connected to the equipment..

### 5.1.6 Initial start-up and setting of operation

For initial start-up, follow the procedure below.

Due to its function, an **HC2-5GRL** is always used inside a transmitter which includes an exciter and two RF amplifiers. The description given in this section therefore refers to these devices in general.

When the **HC2-5GRL** is powered up, check that the ON lamp lights up. The LCD display immediately shows a presentation screen, after which it switches to the default screen that shows the forward and reflected power values.

Activate the exciter at minimum power and wait for it to lock onto the working frequency. Once the exciter has locked on, gradually increase its output power, checking the exciter instruments, the amplifiers and the combiner display. Increase the power of the exciter until the combiner output reaches the desired value, that is, the full power of the station at the very most.

At this point, the software management system can be used to check all the operating parameters of the device.

Normally, the device does not require supervision for its operation. In the event of alarm conditions, these are managed automatically by the protection system and are notified to the user via the LEDs on the panel and messages on the display.

## 5.2 Software

This chapter describes how the microprocessor controls the hybrid combiner, and how the user can interact with the software.

Note that the user can give commands to the device at the buttons on the panel only when the device is put into **LOCAL** mode at the selector on the front panel. Otherwise, the user can only read the parameters without modifying them.

Note that some of the parameters that are measured and shown to the user may, in some cases, not be available. This happens when, for physical reasons, the measured values are not meaningful for use in the control software.

When the value of a parameter is not available for this reason, the symbol “==” is shown in its place on the display.

Figure 5-1 shows the overall diagram of the combiner software, essentially consisting of a predefined screen and a set of menus.

When switched on, the LCD display shows the presentation screen featuring the name of the equipment:

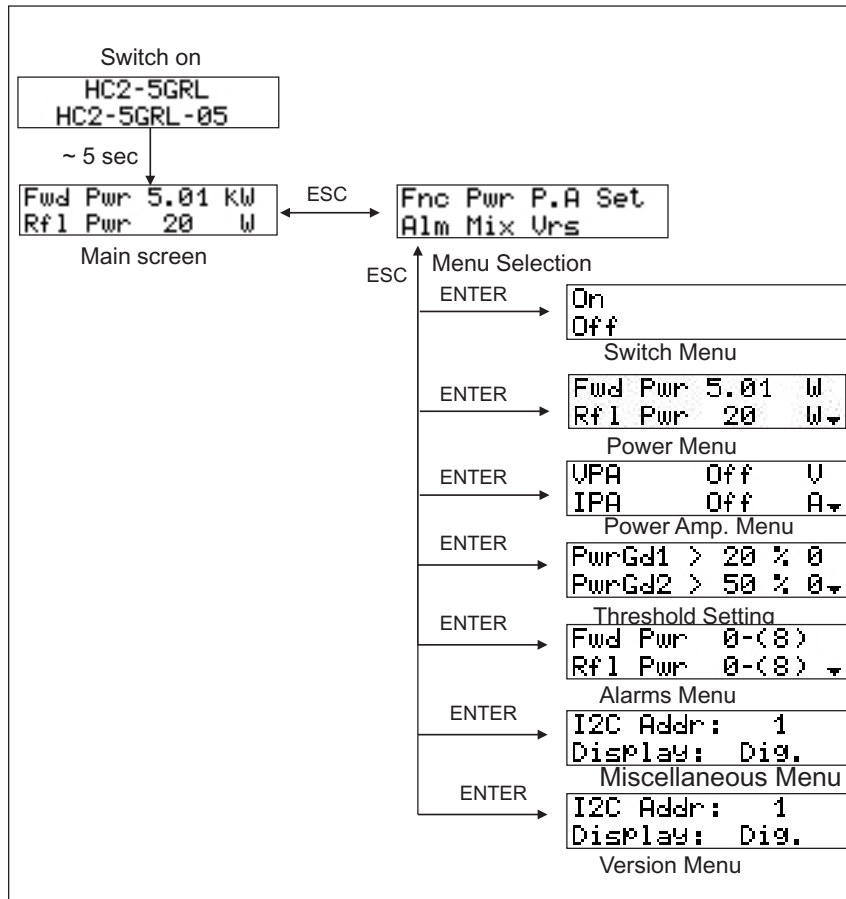
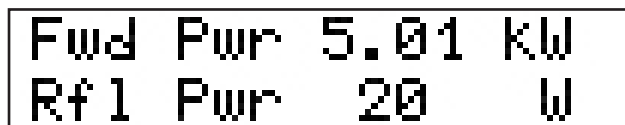

Figure 5-1: HC2-5LCD management software



After a few seconds, the default screen appears. This shows the values of the forward and reflected power instant by instant:





The software remains on this screen indefinitely until the user presses the **ESC** button.

Pressing **ESC** takes you to the selection screen, from which you can access all the other menus:



Pressing **ESC** again takes you back to the default screen.

To enter one of the submenus instead, select its name (which will be highlighted by a blinking cursor) with the buttons  or  and then press the **ENTER** button.

### 5.2.1 Operation Menu (Fnc)



From this menu, the user can “turn on” or “turn off” the hybrid coupler.



The effect of this command is that when the **HC2-5GRL** is turned **OFF**, the internal conductor of the **INTERLOCK** connector is grounded, in order to force the exciter in stand-by mode (this can only happen if the exciter has an interlock option, such as those produced by RVR, and if the relative connector is correctly connected to the hybrid combiner). At the same time, the auxiliary mains supply output is opened, so that if an exciter is connected, it is switched off.

When the hybrid coupler is placed in **OFF** mode, the software waits a few seconds to allow the device to cool, after which the fans are also turned off.

Every two hours, when the device is **OFF**, the software activates the fans for a short time to eliminate the heat generated by the circuitry and to prevent the fans from blocking in the event of long periods of inactivity.



By turning the hybrid coupler back **ON**, the interlock circuit is reopened, re-enabling the supply of power from the connected exciter; the auxiliary power output is powered and the fans are restarted.

### 5.2.2 Power menu (Pwr)

This screen, composed of several lines that can be scrolled through with the buttons  and , shows the user all the measurements relating to the behaviour of the power section of the amplifier:



- Forward Power (Fwd Pwr)
- Reflected Power (Rfl Pwr)
- Standing Wave Ratio (SWR) (Not active)
- Input Power (Inp Pwr) (Not active)
- Rejected PWR (Rej PWR)

Depending on the device configuration, some of the measurements can be disabled.



The following figure shows the complete screen (only two lines are visible on the display at a time, use the buttons  and  to scroll through it):

Fwd Pwr	5.01	kW
Rfl Pwr	20	W
SWR	Off	
Inp Pwr	On	
Rej PWR	17	W

### 5.2.3 Power Amplifier (PA) Menu

This screen, composed of several lines that can be scrolled through with the buttons  and  , shows the user all the measurements relating to the device:

- Voltage (VPA) - Disabled
- Current (IPA) - Disabled
- Efficiency - Disabled
- Temperature
- Supply voltage

The following figure shows the complete screen (only two lines are visible on the display at a time, use the buttons  and  to scroll through it):

VPA	Off	V
IPA	Off	A
Eff.	Off	%
Temp.	22.8	C
Mains	5	%

Note that the first three lines of the screen are not greyed out on the **HC2-5GRL** as they are not valid for a hybrid coupler.

## 5.2.4 Threshold setting menu

As mentioned in the introduction, the combiner offers three warning thresholds that can be set by the user. Each of them is compared with the level of one of the device's operating parameters. The comparison results are made available on the telemetry connector, on the contacts of the optional external telemetry board, and can be read on the display as “O” (open, i.e. the result is false) or “C” (closed, i.e. the result is true).





Two of the settable thresholds (*Power Good*) refer to the level of emitted power, while for the third the quantity of reflected power is verified (*Reflected Warning*).

The thresholds are expressed in terms of percentage of the full scale of the measurement considered.

The full scales of the measurements monitored by the warning thresholds for the **HC2-5GRL** are:

- Forward power      5000W
- Reflected power    500W

To change the threshold values, follow the procedure below after setting the **LOCAL** mode with the selector:

- Select the line to be modified (with the buttons  and  )
- Press the **ENTER** button
- Change the threshold value (buttons   and  )
- Press **ENTER** to confirm

The following figure shows an example of configuration of this menu.

PwrGd1	>	20	%	0
PwrGd2	>	50	%	0
RflWar	>	70	%	0

In this example, the alarm thresholds are:

- PwrGd 1              1000 W      (20% X 5000W)
- PwrGd2              2500 W      (50% X 5000W)
- RflWar                350 W        (70% X 500W)





### 5.2.5 Alarms Menu (Alm)

This menu offers the user information on the status of the protection system incorporated in the hybrid coupler.

It consists of a certain number of lines, each of which contains the name of the variable controlled by the protection system and the type of intervention that has been carried out by the system.

The latter can be of the type **X - (Y)**, **Wait**, or **Dis.** (Disabled).

The explanation of the hybrid coupler protection system is given separately further on.

The appearance of this menu is as follows (only two lines are visible on the display at a time, use the buttons  and  to scroll through it):

Fwd Pwr	0-(8)
Rfl Pwr	0-(8)
InP Pwr	Dis.
U.P.A.	Dis.
I.P.A.	Dis.
Temp.	Wait
Rej PWR	Dis.
Mains	Wait
SWR	Dis.
Eff.	Dis.

This menu essentially acts as an aid to help the technician identify the causes of possible malfunctions.

### 5.2.6 Miscellaneous Menu (Mix)

This menu allows you to perform two actions:

- Set the address for the serial bus connection, type I<sup>2</sup>C
- Set the display mode of the main menu

```
I2C Addr:  1
Display:  Dig.
```

The I<sup>2</sup>C network address is relevant when the hybrid coupler is connected in an RVR transmission system that uses this protocol. It is recommended not to change it without reason.

The display mode of the main menu may be **Dig**ital or **Anal**ogue:

```
Rf1 Pwr  6 ▾
■■
```

In analogue display mode, a small triangle indicates the reflected power level set in the Threshold setting menu (under RflWar), while the lower bar shows the instantaneous reflected power level.

This type of display is useful when a device that needs to be tuned, such as a cavity, is connected to the output of the hybrid coupler.

### 5.2.7 Versions menu (Vrs)

This screen shows the versions of the hardware (H.V.) and software (S.V.) of the equipment.

```
I2C Addr:  1
Display:  Dig.
```

## 5.2.8 Protection System

The protection system implemented in the hybrid coupler is based on two types of intervention, “Foldback” and temporary disabling.

### 5.2.8.1 Foldback

The foldback circuit controls the level of DC voltage at a **COMMON BUS** connector on the back of the **HC2-5GRL**.

The foldback voltage remains constant until one of the measurements associated with the foldback exceeds its nominal value (full scale). When this happens, the voltage is decreased proportionally as the threshold is exceeded, and a yellow LED on the front panel indicates the intervention of the circuit.

In the **HC2-5GRL**, the measurements associated with the foldback are:

- Reflected power
- Imbalance power
- Temperature

Generally, the decrease in the delivered power will have the effect of reducing the measurement that caused the foldback intervention, in order to reach a new point of balance.

If for any reason it is not possible to reach the point of balance, the protection system of the **HC2-5GRL will intervene** in the Power Off/Restart mode.

### 5.2.8.2 Power Off/Restart

The second type of reaction consists in putting the transmitter in stand-by when one of the variables controlled by the protection system exceeds the set value.

To put the transmitter in stand-by, the coupler disables power delivery from the exciter (and therefore of the whole transmitter) via the interlock connector.

After the transmitter has been inhibited, depending on the type of event that occurred, it will be reactivated at the end of a fixed time interval or only after the condition that caused the block has been eliminated.

In the alarm menu, the first type of configuration is indicated with **X - (Y)**, while the second is indicated with the word **Wait**. The third possibility is that the system does not implement the protection on the basis of a certain parameter: this is indicated with **Dis.** (Disabled).

The intervention of the protection (RF power disabled) is signalled by activation of the yellow **WAIT** LED, while the cause of the system intervention is shown on the display.

When the protection system intervenes due to a “cyclic” type parameter, a counter is increased (the X value in the alarms menu). If the counter reaches the maximum allowed cycle value (Y), the hybrid coupler is permanently switched off, and the red **FAULT** LED on the front panel lights up.

The user can press the **ALARMS RESET** button to interact with the protection system. The effect is different depending on the state the device is in when the button is pressed:

- If the transmitter is in stand-by during the time interval envisaged before a restart attempt, or if the system is permanently off (i.e. it is in **FAULT** status), pressing the button switches on the hybrid coupler immediately and the alarm counters will be reset to zero.
- If the system is transmitting, but alarms have occurred previously, so that some of the counters are not at “0”, pressing the button has no effect unless you do so while in the alarm menu. In this way it is possible to be sure that the user is aware of the alarms that have occurred before resetting them.

The alarm counters are automatically reset by the system, i.e. without user intervention, after thirty minutes of normal operation without the hybrid coupler entering alarm mode.

## 6. Identification and Access to the Modules

### 6.1 Identification of the Modules

The **HC2-5GRL** is composed of several modules which are interconnected with connectors to facilitate maintenance and replacement of the modules.

#### 6.1.1 HC2-5GRL Top view

The figure below shows the top view of the device, indicating the various components.

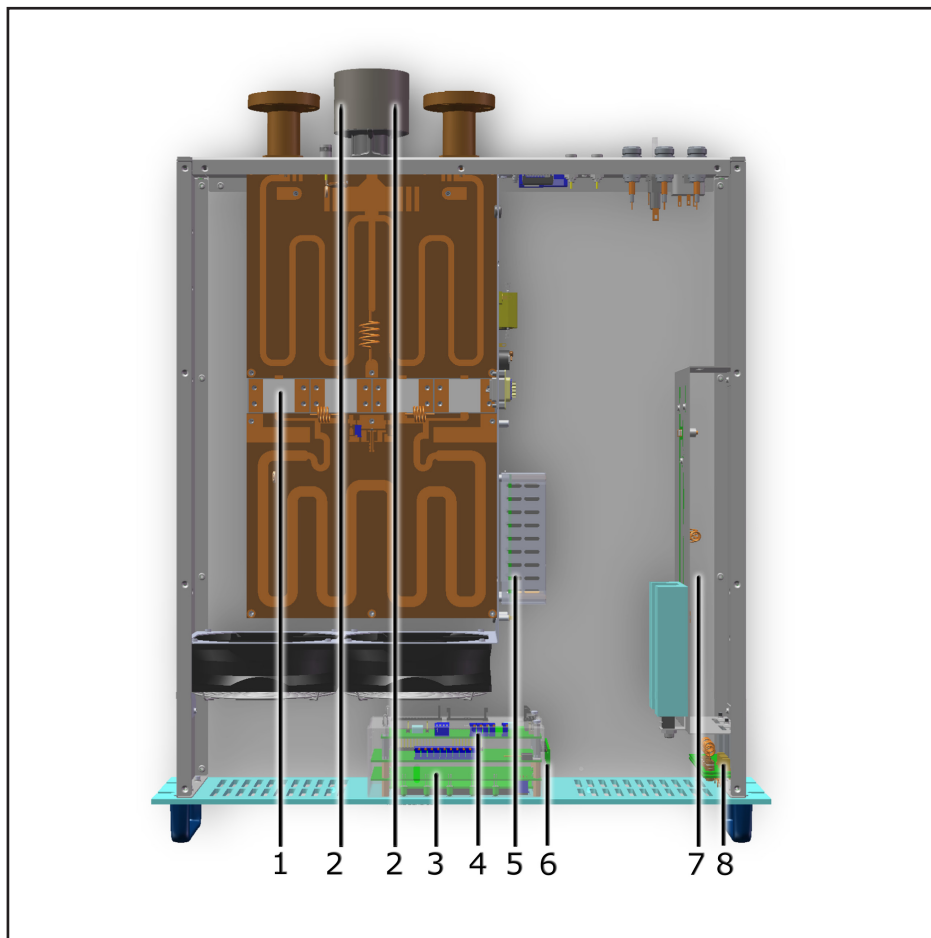

figure 8.1

- [1] Combiner Block
- [2] Measurement Board
- [3] Panel Block and CPU Board
- [4] CPU Adapter Board
- [5] Services Power Supply
- [6] CPU Adapter Board
- [7] Divider Board
- [8] Phase Variator Board

## 6.2 Spare Parts List

Below is a list of the spare parts and their codes for the purpose of replacing the modules in case of maintenance.

Spare Parts Name	Spare Parts Code
Fans	VTL9GL1224J
CPU Panel + Display	SP-PAN021A
Switching power supply	PSSWEPP10024
Power meter block	SP-MTR021A

## 7. Principles of Operation

There is a schematic view of the modules and connections that make up the **HC2-5GRL** in figure 7.1.

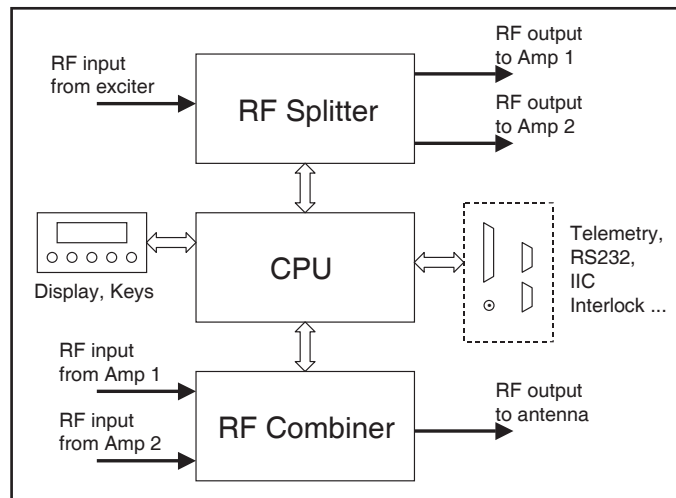

Figure 7.1

A brief description of the functions of each module is given below, and the complete diagrams and layouts of the boards can be found in the “Technical Appendix” Vol.2.

### 7.2 Description of the modules

#### 7.1.1 Power supply

The power supply of the **HC2-5GRL** uses a 24 V switching power supply which powers the CPU section.

The CPU section and the remote board have built-in rectifier bridges and voltage regulators.

The CPU section can optionally be powered with an external 24 V DC power source; this is automatically selected by the CPU section if the main power supply fails for any reason.

#### 7.1.2 Divider Circuit

The divider circuit is used to split the RF signal from the exciter and supply it to the two amplifiers.



It is a Wilkinson schematic circuit with strip-line and coaxial cables, and includes the circuitry necessary to equalize the phases on the two outputs for driving the amplifiers.

The divider contains a resistive termination to absorb any imbalance power in case of failures or differences in performance by one of the amplifiers.

### 7.1.3 Coupler circuit

The combiner circuit has the function of adding the RF power delivered by the two amplifiers and delivering it to the antenna output.

It is a Wilkinson schematic circuit with strip-line and 50 Ohm coaxial cables.

The combiner contains special resistive terminations mounted on the main heat sink to absorb any imbalance power in case of bad adjustments, differences in performance between the amplifiers or malfunctions.

### 7.1.4 CPU

This subsystem is composed of three boards: the CPU board itself, the analogue section and the interconnection and EMI filtering board.

This subsystem implements all the software functions described above (measurements, protections, controls, data visualizations, communications). The analogue circuitry carries out the normalizations and measurements on the various parameters that the device keeps under control.

The CPU card interfaces with external devices via a dedicated telemetry connector, the RS232 serial port and an IIC type port.

### 7.1.5 External telemetry card (optional)

This optional device is designed to interface with the telemetry connector of the **HC2-5GRL**, and its main purpose is to provide the user with a certain number of relay contacts connected to the operating status of the device. The contacts can be normally open or closed and are operated by the four user-configurable thresholds as well as by LOC/REM, WAIT, FAULT, ON, OFF, INHIBIT.

The user commands (ON, OFF, ALARM RESET, INHIBIT) also interface with this board by means of dedicated relays. The relays can be powered either by the **HC2-5GRL** or by an external power supply and a contact is provided for each user input which must be shorted to earth to activate the signal.

ON, OFF and ALARM RESET are pulse type inputs, INHIBIT is a permanent type input: when it is earthed the device is inhibited and as soon as it is released, the coupler (and the entire transmitter) is reactivated.

All these outputs and the available inputs of the device are available on a terminal block.

The analogue signals supplied by the hybrid coupler are replicated on a DB9 connector.

## 7.2 Compensation

The factory calibration of the coupler is such as to guarantee satisfactory operation of the transmitter to which it is part of the whole range.

However, there may be cases in which it is necessary to compensate the **HC2-5GRL**, for example if you have replaced RF interconnection cables with the amplifiers using cables of different characteristics or lengths, or if you want to optimize the transmitter performance for operation on a certain frequency.



**CAUTION: it is not recommended to entrust the operations described in this chapter to personnel who do not have in-depth knowledge of the device and its operating principles.**

The capacitive trimmers in the **HC2-5GRL** can be installed in two positions, depending on the versions of the device:

- directly on the divider circuit
- on two special printed circuits accessible from the front panel of the device

In general, the rightmost capacitors are those used to adjust the RF path relative to the amplifier connected to the rightmost output connector of the coupler. For reference, see the screen printed diagram on the rear panel of the **HC2-5GRL**.

To efficiently regulate the capacitors, it is essential to use an isolated tool, e.g. a plastic screwdriver.

The following procedures are optimized for adjusting the coupler in both cases.

### 7.2.1 Compensators accessible from the front panel

The procedure to follow in this case is identical to the previous case, except for the following points:

- It is not necessary to remove the coupler covers: the trimmers are accessed directly through the ventilation slots of the device (figure 5)

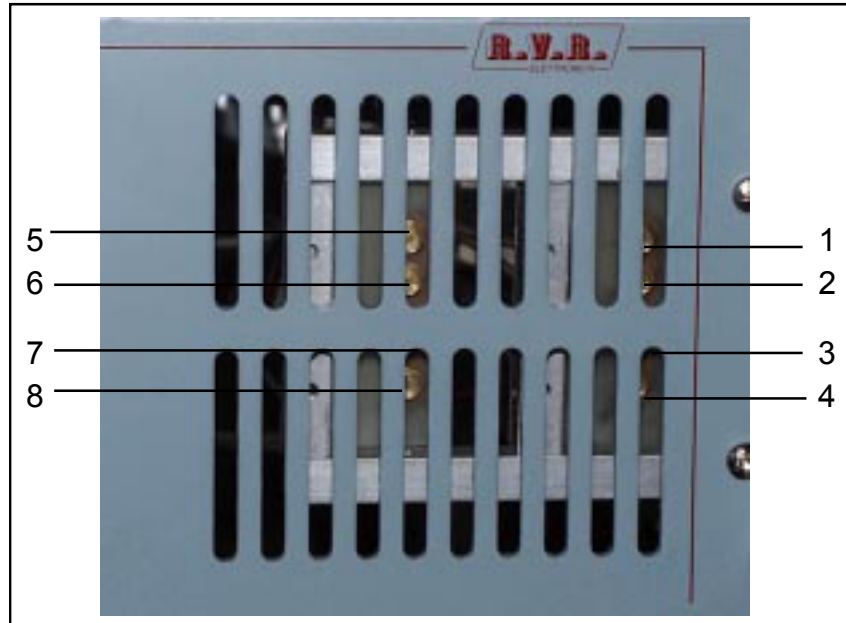

Figure 5

- For each amplifier, there are two *pairs* of capacitive trimmers: 1,2,3 and 4 for the amplifier “A”, 5,6,7 and 8 for the amplifier “B” (see the screen printed diagram on the back of the coupler for reference).
- Remember to use an insulated screwdriver to adjust the capacitors to avoid adjustment errors due to short circuits.

## 8. Maintenance and Repair Procedures

### 8.1 Introduction

This section gives general information on maintenance and electrical adjustments for the **HC2-5GRL** exciter.

Maintenance is divided into two sections depending on the complexity of the procedure and the test equipment required to complete the maintenance.

### 8.2 Safety Considerations

When the amplifier is operational, dangerous voltages, high currents, and strong RF signals are present inside.



**CAUTION:** Do not remove any covers without first turning off the device and make sure you have closed them all before restarting the device. Be sure to disconnect the amplifier from the mains before proceeding with any maintenance on the system.

### 8.3 Ordinary maintenance

The only regular maintenance required for the **HC2-5GRL** is periodic replacement of the fans and cleaning to remove dust in the air filter and any traces inside the amplifier.

The frequency of these operations depends on the operating conditions of the device: ambient temperature, level of dust in the air, humidity, etc...

It is advisable to carry out a preventive check every 6 months, and to replace the fans that make abnormal noises.

The fans should be replaced in case of problems as soon as possible and in any case at least every 24 months.

#### 8.3.1 Replacing malfunctioning fans

- Open the top cover of the **HC2-5GRL** by unscrewing all the screws.
- Identify the fan to be replaced.
- Unscrew all points **A** using a Phillips screwdriver.

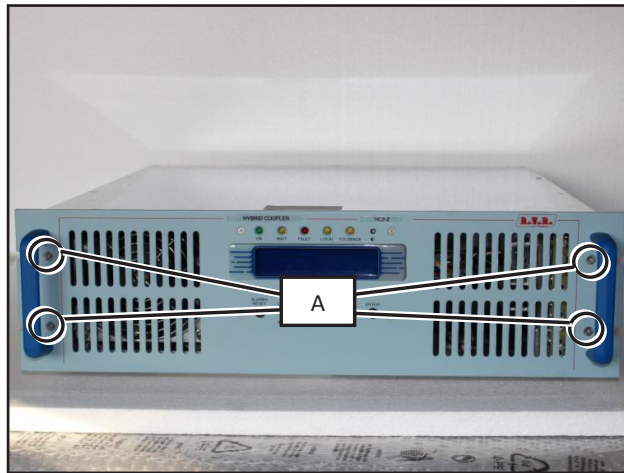

- Unscrew all points **B** and **C** using a Phillips screwdriver.

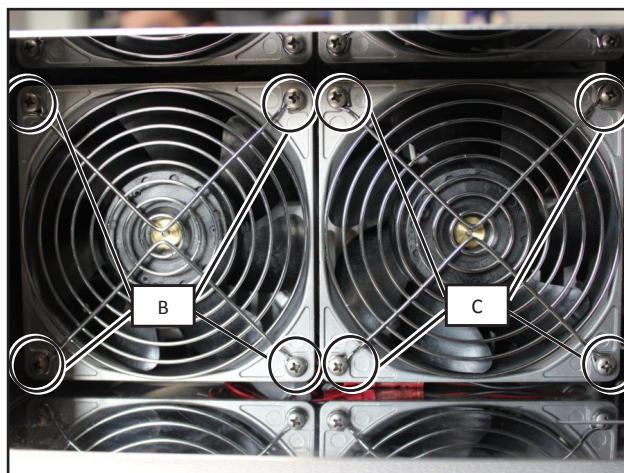

- Disconnect the connectors at points **D**.

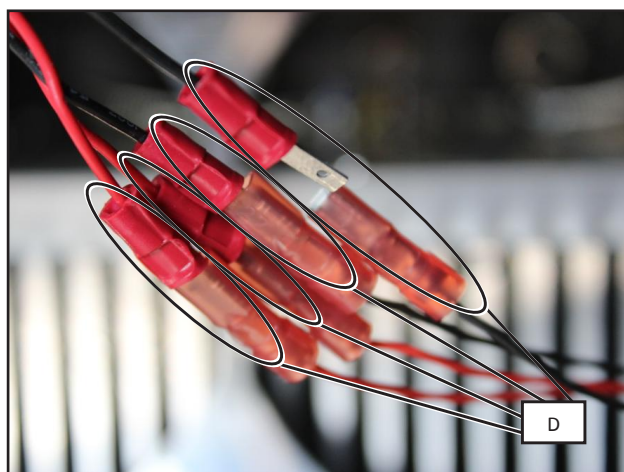

- Remove the malfunctioning fans.
- Insert the new fans (mod. **VTL9GL1224J SANYO DENKI**).
- Repeat the procedure above in reverse order to reassemble and fix the fan in its seat.
- Put the covers back and tighten all the screws needed to close it.

## 8.4 Replacing the Modules

Arrange for authorized and qualified technical personnel to replace the component parts in the device.

### 8.4.1 Replacing the panel board

- Open the top cover of the **HC-2-5GRL** by unscrewing all the screws.
- Identify the module to be replaced.
- Unscrew all points **A** using a Phillips screwdriver.

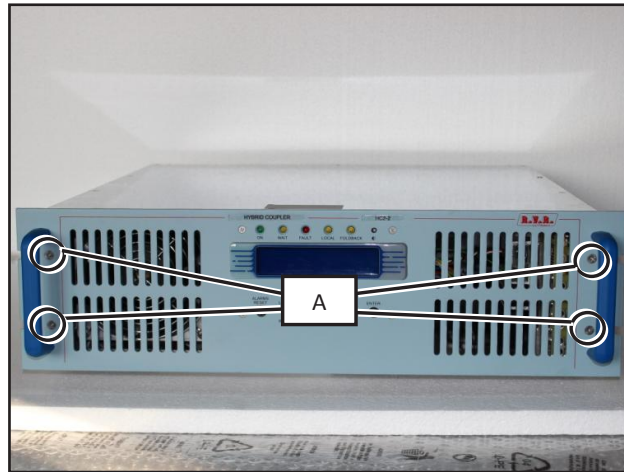

- Unscrew all points **B** using a Phillips screwdriver.





- Disconnect the connectors C.

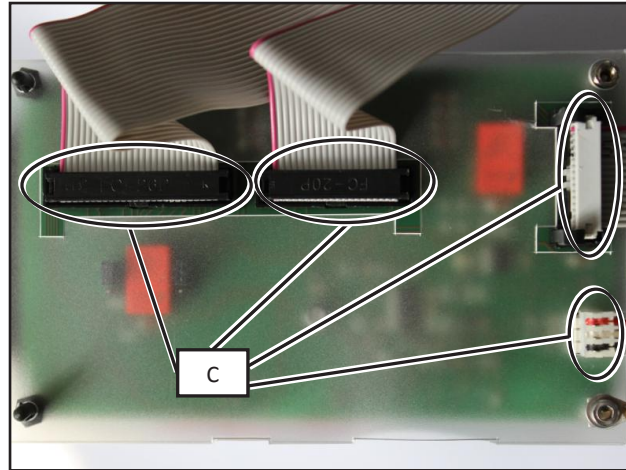

- Disconnect board D.

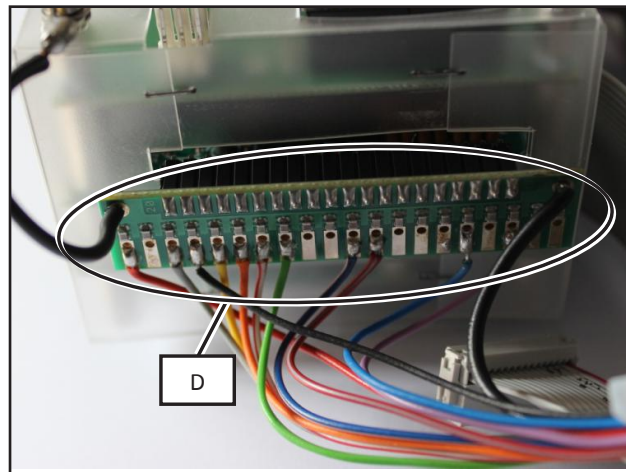

- Disconnect board D.

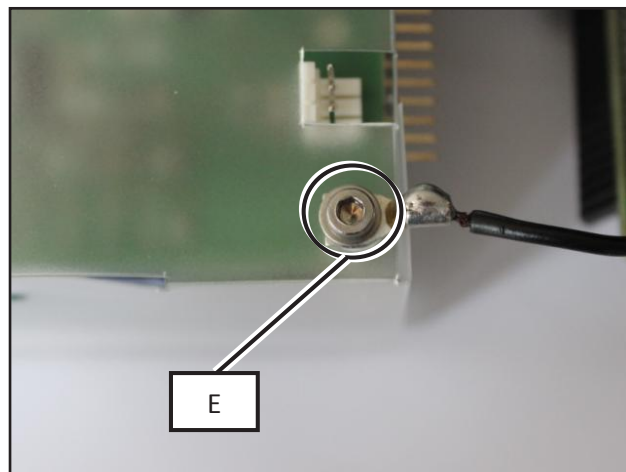

- Remove the power distribution board and replace it with the new module.
- Repeat the procedure above in reverse order to reassemble and fix the module in its seat.
- Put the cover back and tighten all the screws needed to close it.

*Page intentionally left blank*











**R.V.R Elettronica**

Via del Fonditore, 2 / 2c  
Zona Industriale Roveri · 40138 Bologna · Italy  
Phone: +39 051 6010506 · Fax: +39 051 6011104  
e-mail: [info@rvr.it](mailto:info@rvr.it) · web: <http://www.rvr.it>

Member of CISQ Federation



The RVR Logo, and other RVR referenced products and services are trademarks of RVR Elettronica in Italy, other countries or both. RVR © 1998 all rights reserved.  
All other trademarks, trade names or logos used are the property of their respective owners.