

TEX30-LCD

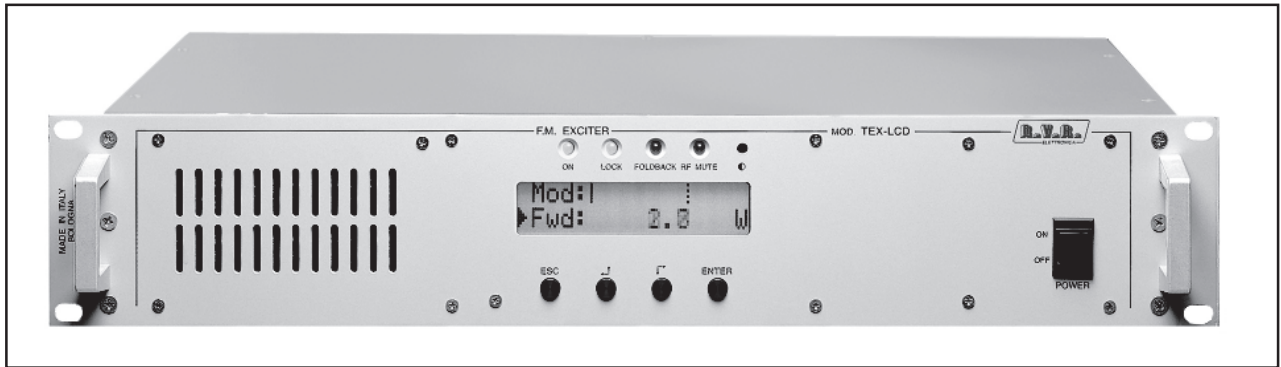

User Manual Volume 1

Manufactured by  Italy



File name: TEXLCD_EN.P65

Version: 3.1

Date: 10/05/2005

Revision History

Date	Version	Reason	Editor
08/04/05	3.0	Third Version	J. Berti
10/05/05	3.1	New Panel board & Software description	J. Berti

TEX30-LCD - User Manual
Version 3.1

© Copyright 2003-2005
R.V.R. Elettronica SpA
Via del Fonditore 2/2c - 40138 - Bologna (Italia)
Telefono: +39 051 6010506
Fax: +39 051 6011104
Email: info@rvr.it
Web: www.rvr.it

All rights reserved

Printed and bound in Italy. No part of this manual may be reproduced, memorized or transmitted in any form or by any means, electronic or mechanic, including photocopying, recording or by any information storage and retrieval system, without written permission of the copyright owner.

Notification of intended purpose and limitations of product use

This product is a FM transmitter intended for FM audio broadcasting. It utilises operating frequencies not harmonised in the intended countries of use. The user must obtain a license before using the product in intended country of use. Ensure respective country licensing requirements are complied with. Limitations of use can apply in respect of operating frequency, transmitter power and/or channel spacing.

Declaration of Conformity

Hereby, R.V.R. Elettronica SpA, declares that this FM transmitter is in compliance with the essential requirements and other relevant provisions of Directive 1999/5/EC.



Table of Contents

1. Preliminary Instructions	1
2. Warranty	1
3. First Aid	1
3.1 Treatment of electrical shocks	1
3.2 Treatment of electrical Burns	2
4. Removal from the packing	3
4.1 General Description	3
5. Quick guide for installation and use	5
5.1 Preparation	5
5.2 Use	5
5.3 Settings and calibration	6
5.4 Software	7
5.5 Optional Functions	13
6. External Description	16
6.1 Front Panel	16
6.2 Rear Panel	17
6.3 Connectors description	18
7. Technical Specifications	19
7.1 Mechanical characteristics	19
7.2 Electrical characteristics	19
7.3 Spare Parts	21
8. Working Principles	22
8.1 Power Supply	22
8.2 Panel board	23
8.3 Main board	23
8.4 Power Amplifier	24
8.5 Control Board	24
8.6 Telemetry board	25
9. Identification and Access to the Modules	26
9.1 Identification of the Modules	26
9.1.1 Upper view	26

This page was intentionally left blank

1. Preliminary Instructions

This manual is written as a general guide for those having previous knowledge and experience with this kind of equipment, well conscious of the risks connected with the operation of electrical equipment.

It is not intended to contain a complete statement of all safety rules which should be observed by personnel in using this or other electronic equipment.

The installation, use and maintenance of this piece of equipment involve risks both for the personnel performing them and for the device itself, that shall be used only by trained personnel.

R.V.R. Elettronica SpA doesn't assume responsibility for injury or damage resulting from improper procedures or practices by untrained/unqualified personnel in the handling of this unit.

Please observe all local codes and fire protection standards in the operations of this unit.



WARNING: always disconnect power before opening covers or removing any part of this unit.

Please observe all local codes and fire protection standards in the operations of this unit.



WARNING: this device can irradiate radio frequency waves, and if it's not installed following the instructions contained in the manual and local regulations it could generate interferences in radio communications.

This is a "CLASS A" equipment. In a residential place this equipment can cause hash. In this case can be requested to user to take the necessary measures.

R.V.R. Elettronica SpA reserves the right to modify the design and/or the technical specifications of the product and this manual without notice.

2. Warranty

Any product of **R.V.R. Elettronica** is covered by a 24 (twenty-four) month warranty.

For components like tubes for power amplifiers, the original manufacturer's warranty applies.

R.V.R. Elettronica SpA extends to the original end-user purchaser all manufacturers warranties which are transferrable and all claims are to be made directly to R.V.R. per indicated procedures.

Warranty shall not include:

- 1 Re-shipment of the unit to R.V.R. for repair purposes;
- 2 Any unauthorized repair/modification;
- 3 Incidental/consequential damages as a result of any defect;
- 4 Nominal non-incidentual defects;
- 5 Re-shipment costs or insurance of the unit or replacement units/parts.

Any damage to the goods must be reported to the carrier in writing on the shipment receipt.

Any discrepancy or damage discovered subsequent to delivery, shall be reported to **R.V.R. Elettronica** within 5 (five) days from delivery date.

To claim your rights under this warranty, you should follow this procedure:

- 1 Contact the dealer or distributor where you purchased the unit. Describe the problem and, so that a possible easy solution can be detected.

Dealers and Distributors are supplied with all the information about problems that may occur and usually they can repair the unit quicker than what the manufacturer could do. Very often installing errors are discovered by dealers.

- 2 If your dealer cannot help you, contact **R.V.R. Elettronica** and explain the problem. If it is decided to return the unit to the factory, **R.V.R. Elettronica** will mail you a regular authorization with all the necessary instructions to send back the goods;
- 3 When you receive the authorization, you can return the unit. Pack it carefully for the shipment, preferably using the original packing and seal the package perfectly. The customer always assumes the risks of loss (i.e., R.V.R. is never responsible for damage or loss), until the package reaches R.V.R. premises. For this reason, we suggest you to insure the goods for the whole value. Shipment must be effected C.I.F. (PREPAID) to the address specified by R.V.R.'s service manager on the authorization



DO NOT RETURN UNITS WITHOUT OUR AUTHORIZATION AS THEY WILL BE REFUSED

- 4 Be sure to enclose a written technical report where mention all the problems found and a copy of your original invoice establishing the starting date of the warranty.

Replacement and warranty parts may be ordered from the following address. Be sure to include the equipment model and serial number as well as part description and part number.



R.V.R. Elettronica SpA
Via del Fonditore, 2/2c
40138 BOLOGNA
ITALY
Tel. +39 051 6010506

3. First Aid

The personnel employed in the installation, use and maintenance of the device, shall be familiar with theory and practice of first aid.

3.1 Treatment of electrical shocks

3.1.1 If the victim is not responsive

Follow the A-B-C's of basic life support.

- Place victim flat on his back on a hard surface.
- Open airway: lift up neck, push forehead back (**Figure 1**).

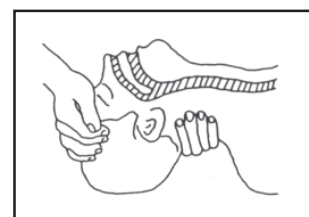

Figure 1

- clear out mouth if necessary and observe for breathing
- if not breathing, begin artificial breathing (**Figura 2**): tilt head, pinch nostrils, make airtight seal, four quick full breaths. Remember mouth to mouth resuscitation must be commenced as soon as possible.



Figura 2

- Check carotid pulse (**Figura 3**); if pulse is absent, begin artificial circulation (**Figura 4**) depressing sternum (**Figura 5**).



Figure 3

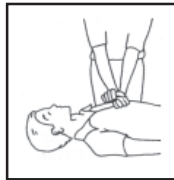

Figure 4

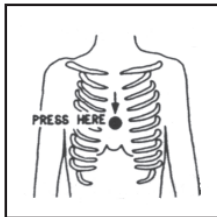

Figure 5

- In case of only one rescuer, 15 compressions alternated to two breaths.
- If there are two rescuers, the rythm shall be of one brath each 5 compressions.
- Do not interrupt the rythm of compressions when the second person is giving breath.
- Call for medical assistance as soon as possible.

3.1.2 If victim is responsive

- Keep them warm.
- Keep them as quiet as possible.
- Loosen their clothing (a reclining position is recommended).
- Call for medical help as soon as possible.

3.2 Treatment of electrical Burns

3.2.1 Extensive burned and broken skin

- Cover area with clean sheet or cloth.
- Do not break blisters, remove tissue, remove adhered particles of clothing, or apply any salve or ointment.
- Treat victim for shock as required.
- Arrange transportation to a hospital as quickly as possible.
- If arms or legs are affected keep them elevated.

If medical help will not be available within an hour and the victim is conscious and not vomiting, give him a weak solution of salt and soda: 1 level teaspoonful of salt and 1/2 level teaspoonful of baking soda to each quart of water (neither hot or cold).

Allow victim to sip slowly about 4 ounces (half a glass) over a period of 15 minutes.

Discontinue fluid if vomiting occurs.

DO NOT give alcohol.

3.2.2 Less severe burns

- Apply cool (not ice cold) compresses using the cleansed available cloth article.
- Do not break blisters, remove tissue, remove adhered particles of clothing, or apply salve or ointment.
- Apply clean dry dressing if necessary.
- Treat victim for shock as required.
- Arrange transportation to a hospital as quickly as possible.
- If arms or legs are affected keep them elevated.

4. Removal from the packing

The package contains:

- Nr.1 **TEX30-LCD**
- Nr.1 User Manual
- Nr.1 Mains power cables

The following accessories are also available from Your R.V.R. Dealer:

- **Accessories, spare parts and cables**

4.1 General Description

The **TEX30-LCD** is an **exciter for Frequency Modulated audio broadcasting** in a frequency modulation able to transmit in the band between 87.5 and 108 MHz, in step of 10 KHz, with an RF output power adjustable up to a maximum of 30 W into a 50 Ohm standard load.

The **TEX30-LCD** is designed to being contained into a 19" rack box of 2HE.

This exciter contains a low-pass filter that reduces the harmonic emissions to below the limits allowed by international regulations (CCIR, FCC or ETSI), and can therefore be used as a transmitter connected directly to the antenna.

Outstanding audio features this device has are low distortion and intermodulation values and the high signal to noise ratio in mono operation.

Another important feature the **TEX30-LCD** has is its great simplicity of construction and use. The **TEX30-LCD** was designed to be modular. Its various functions are run from modules directly connected to each other with male and female connectors or with flat cables ending in connectors. This type of design makes maintenance operations and any required module replacement easier.

The RF power section uses one MOSFET module able to deliver 30 W.

The working frequency is assured by a thermally-compensated, reference oscillator working within a phase-locked loop (PLL). The **TEX30-LCD** reaches frequency lock within a maximum of 30 seconds.

The **TEX30-LCD** is able to work in all range frequency without calibration and setting operations.

The microprocessor system includes an LCD display and push-button panel for interaction with the user, and implements the following functions:

- Setting the output power
- Setting the operating frequency
- Activation and deactivation of power delivery
- Measurement and display of the working parameters of the exciter
- Communications with outside devices

Four LEDs indicate the machine status and are found on the front panel: ON, LOCK, FOLDBACK and RF MUTE.

The exciter has one input for external 24 VDC power supply. This source of auxiliary power supply, which the user can make through buffer batteries, is used automatically in the case of mains voltage failure.

The exciter's management software is based on a menu system. The user can navigate between the various submenus by using four push buttons: **ESC**, , and **ENTER**.

On rear panel there are Mains connector, with a voltage selector that allow to use different mains voltage (Full range version), audio input and RF output connectors, telemetry connector, protection fuses, two inputs for modulated signals on subcarriers from special external encoders normally used in Europe for RDS (Radio Data Systems) transmission.

5. Quick guide for installation and use

This chapter contains the necessary information for installing and using the machine. In the event any aspects are not completely clear, for example when using the machine for the first time, we recommend you carefully read the entire description contained in this manual.

5.1 Preparation

Unpack the exciter and before doing any other operation, be sure it has not been damaged during transport. In particular check that all the connectors are in perfect condition.

The main fuse can be accessed from the outside on the rear panel (see figures 6.2 - [1]). Extract the fuse carrier with a screwdriver to check its integrity or for replacement, if necessary. The fuse to be used is this type:

Mains Fuse: 3.15 A 5X20

Check that the **TEX30-LCD** switches are in the "OFF" position. The exciter has two switches: one is incorporated in the VDE base for the mains power supply cable and completely interrupts the mains power supply, whereas the second one is on the front panel and inhibits the switching power supply of the machine.

Connect the RF output of the exciter to the antenna cable or to a fictitious load able to dissipate the power generated by the **TEX30-LCD**.



WARNING: in case the load is not present, don't touch the RF output connector during the equipment operation to avoid electric shock and electrocution.

Connect the mains cable to the proper VDE base, placed on the rear panel (see fig. 6.2 - [14]).



WARNING: It is crucial that the mains system being provided with grounding to ensure both the operators' safety and correct operation of the equipment.

Connect the audio cable and RDS/SCA of the signal source to the proper input connectors of the **TEX30-LCD** with the indications of the figure 6.2.

5.2 Use

Switch on the exciter by putting the switch, found on the rear panel, in the "I" position (on), and turn on the switch found on the front panel.

Enter the "Set" menu and set the desired operating frequency. See chapter 5.4 for a description of the various menus.

Set the characteristics (impedance, preemphasis and, if it's necessary, stereo/mono) and the levels of the audio and RDS inputs (if used), by using the switches and trimmer found on the rear panel.



NOTE: by factory, it is delivery with the output power adjustment at minimum and in the "OFF" position. It is however recommended that you always check the set level before activating power supply, especially if the machine is used as a modulator for a power amplifier.

Set the desired power level from the predefined menu, as described in chapter 5.4.

Activate the RF power output from the "Fnc" menu (chap. 5.4.1).

5.3 Settings and calibration

The only adjustments to have made manually on the **TEX30-LCD** are those relating to the audio operation levels and modes.

A trimmer for each one of the exciter's inputs is on the rear panel of the device. The serigraphy on the panel indicates which input each trimmer refers to. The sensitivity of the various inputs can be adjusted using the trimmers within the limits described in the following tables:

- Input sensitivity

Input	Figure 6.2	Trimmer	Sensitivity	Notes
SCA1	[9]	[23]	- 8 ÷ +13 dBm	Input level for 7,5 kHz overall deviation (-20 dB)
SCA2	[21]	[22]	- 8 ÷ +13 dBm	
MPX	[10]	[11]	-13 ÷ +13 dBm	Input level for 7,5 kHz overall deviation (0 dB)
Left/ Mono	[25]	[24]	-13 ÷ +13 dBm	
Right	[13]	[12]	-13 ÷ +13 dBm	

To adjusting the sensitivity level of the inputs, keep in mind that the instantaneous modulation level is given in the predefined menu and that an hatched bar signals the 75 kHz level. To get a proper adjustment, we recommend you put a level signal on the machine's output equivalent to the level of its own audio program and adjust the relative trimmer until the instantaneous deviation coincides with the indication of 75 kHz.

To adjust the levels of the inputs of the subcarriers, you can use a similar procedure while getting help from the "x10" option that can be selected from the **Fnc** menu. With this option, the modulation level indicated is multiplied by a factor 10 so the drawn indication of the predefined menu coincides with a deviation value of 7.5 kHz.

For the stereophonic version, there is a special menu in which the levels of the Right and Left channels are indicated separately with the relative indicators of the nominal levels for the maximum deviation of 75 kHz.

The positions of the DIP switches that are used to select the available options are indicated on the printing.

- Preemphasis (Figure 6.2 - [7]):

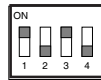

50 μ s

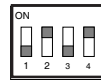

75 μ s

- L and R input impedance (type XLR) (Figure 6.2 - [26]):



Switch 1: R XLR input impedance, ON = 600 Ω , OFF = 10 k Ω

Switch 2: L XLR input impedance, ON = 600 Ω , OFF = 10 k Ω

- MPX operation mode/input impedance (Figure 6.2 - [8]):



Switch 1: Operation mode ON = Mono, OFF = Stereo

Switch 2: MPX input impedance, ON = 50 Ω , OFF = 10 k Ω

5.4 Software

The machine is provided with a two-line LCD display where a set of menus is shown. An overall view of the machine's menus is given in figure 5-1.

One of the following symbols may be present on the left side of the display, depending on the case:

- (Cursor) - The cursor identifies the selected menu where you can have access.
- ▶ (Full arrow) - The parameter highlighted by the arrow can be modified. Questo simbolo è presente nei menù composti da più di due righe come aiuto nello scorrimento del menù.
- ▶▶▶ (Three empty arrows) - The parameter highlighted by the arrows is in phase of modification.
- ▶ (Empty Arrow) - The arrow points out the current line, the parameter of which cannot be modified. This symbol is present in the menus made up of more than two lines to help scroll the menu.

When turned on, the LCD display shows the **predefined screen** with the graphic representation of the instantaneous modulation level and indication of the direct power supplied:

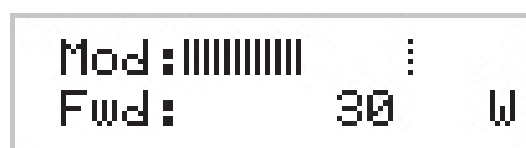

Menu 1



The vertical bars under "Mod" indicate the progress of the modulation in real time; the hatched bar signals the maximum nominal modulation level at 75 kHz (100%).

To **change the set power level**, select the line relating to the power with the **RIGHT/DOWN**  button and keep the **ENTER** push button pressed until it enters the modification mode.

The screen that is shown in the modification mode is similar to the following:



Menu 2

The bottom line gives the instantaneous reading of the power (30W in this example), whereas the bar indicates the set level. To increase the level, press the **RIGHT/DOWN**  push button and to reduce it, press **LEFT/UP** . When the desired level is reached, press **ENTER** to confirm and exit the predefined menu. Note that the set value is stored anyway, so if you press **ESC** or let the timeout go by without pressing a key, the power will remain at the last set level.

The first pressure of a whichever key serves in order to activate the retroillumination when the display is switched off.

The pressure of **ESC** button when the display is switched on, while you are in the predefined menu, serves in order to shown the following **selection screen** from which you can access to all the other menus:

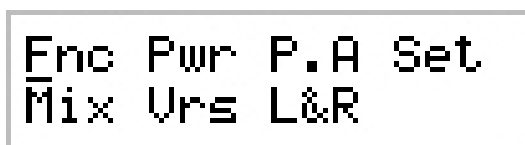

Menu 3

If you instead want to go back to the predefined menu, all you have to do is press the **ESC** push button again.



To enter one of the submenus, select its name (which will be underlined by a blinking cursor) with the  or  push buttons and then press the **ENTER** push button.

Figure 5.1 shows the complete set of the equipment menus.

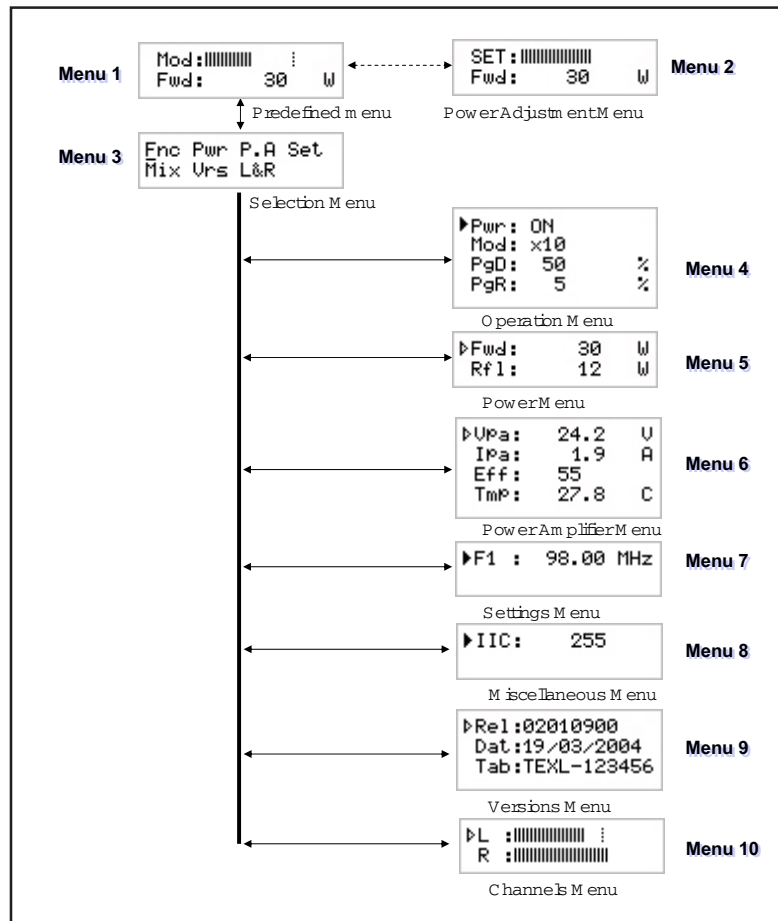

Figure 5.1

If the temperature alarm is enabled, the power supply will come inhibited in case of alarm threshold overcoming, and it will have displayed the following window only in case you are in the **predefined screen**:



Status 1

Once restored the normal operation conditions, the power supply will come rehabilitated with the same modalities antecedent the alarm.





If the modulation ran out, under 20 kHz, for a time of about 5 minutes (not modifiable) the NO AUDIO status comes displayed in the **predefined screen**, but the power does not comes inhibited:



Status 2

5.4.1 Operation Menu (Fnc)

From this menu the user can enable or disable the exciter **power supply**, set the deviation display modality and set up the percentage of **Forward (PgD)** or **Reflected Power Good (PgR)**.

To operate on one of this voices, select the relative line by the  and  buttons, then press and keep pressed the **ENTER** button until the command doesn't come accepted. In this way the Pwr setting will become from On to Off, or viceversa, and the Mod setting from "x1" to "x10" or viceversa. To modify the Power Good value percentage is sufficient, after to have selected the "PgD" or "PgR" voice, set up the value through the  and  buttons, then confirm with **ENTER**.

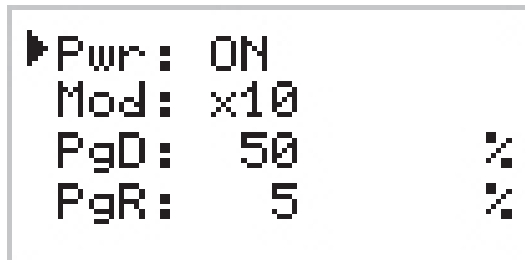

Menu 4

- Pwr Enables (On) or disables (Off) the power supply of the exciter.
- Mod Display modality of the modulation selectable between "x1" and "x10". The indication of the instantaneous deviation is multiplied by a factor 10 in the "X10" mode, so the hatched indicator on the predefined menu will coincide with the 7.5 kHz value instead of 75 kHz. This display mode is useful when you want to view low deviation levels such as, for example, those due to the pilot tone or to the subcarriers.
- PgD Regulation of the Power Good threshold relative to the forward power. The percentage value of Power Good is referred to the nominal power of the machine, that is 30 W, not to the supplied forward power. If a value equal to 50% is setted, it will correspond indifferently to 15 W from the set up power. The Power Good function is a control and alarm function on the supplied power. When the output power fall under the threshold value of Power Good set, the machine modifies the pin state [7] of "Remote" DB15 connector on the rear panel (figure 6.2 note [18]).
- PgR Regulation of the Power Good threshold relative to the forward power. The percentage value of Power Good is referred to the nominal power of the machine, that is 3 W, not to the supplied forward power. If a value equal to 5% is set, it will correspond to 150 mW indifferently from the set up power.



NOTE: This alarm does not have effect on any output signal on the DB15 "Remote" connector, placed on the rear panel of the equipment, and it works only in presence of systems equipped of telemetry.

5.4.2 Power Menu (Pwr)

This screen shows the user the measures relating to the exciter's RF power output:

▶Fwd:	30	W
Rfl:	12	W



Menu 5

Fwd Visualization of the Forward Power (Fwd).

Rfl Visualization of the Reflected Power (Rfl).

The values shown are "readings", and therefore cannot be modified (note the empty triangle). To modify the power setting, use the predefined menu as described above.

5.4.3 Power Amplifier Menu (P.A)

This screen, consisting of four lines that can be scrolled with the  and  buttons, shows to the user the measures relating to the final power amplifier of the equipment:

▶Vpa:	24.2	V
IPa:	1.9	A
Eff:	55	
Tmp:	27.8	C

Menu 6

VPA Visualization of the amplifier module voltages.

IPA Visualization of the amplifier module current.

Eff Visualization of the efficiency.

Tmp Visualization of the inner temperature of the machine.

5.4.4 Settings Menu (Set)

This menu lets to read and set the operating frequency.

▶F1 :	98.00	MHz
-------	-------	-----

Menu 7

F1 After having set a new frequency value, press the ENTER button to confirm the choice. The exciter will release from the current frequency (the LOCK LED turns off) and it will latch onto the new operating frequency (LOCK turns back on). Instead, if you press ESC or let the timeout go by, the frequency will remain set at the previous value.

5.4.5 Miscellaneous Menu (Mix)

This menu allows you to set the machine's address in a serial bus connection (I²C type):

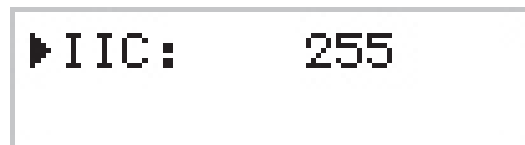

Menu 8

IIC Regulation of the I²C address. The I²C network address is important when the exciter is connected to a company's transmission system that envisages use of this protocol. We recommend you do not modify it without a good reason.

5.4.6 Versions Menu (Vrs)

This screen shows the version and the release date of the software.

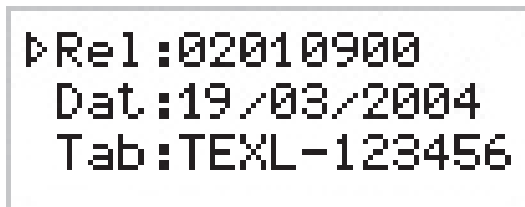

Menu 9

Rel Visualization of the software release.

Dat Visualization of the date release.

Tab Visualization of the release of the configurations table loaded in memory

5.4.7 Channels Menu (L&R)

The right and left channel input levels are depicted with horizontal bars, as shown in the following figure.

The hatched pointer indicates the level that corresponds with the total deviation at 100%, and is useful to regulate the input levels of the audio channels.

Menu10

- L Visualization of the Left channel Vmeter.
- R Visualization of the Right channel Vmeter.

5.5 Optional Functions

Optional functions can be added and/or modified for the equipment described in this manual. The available functions are carried in the continuation and can be requested to R.V.R. Elettronica at the moment of the order.

5.5.1 FSK Option

The FSK function, generates periodic shifts of the transmission carrier frequency, realizes in way to generate a Morse code that carried the Radio Identification Code.



This function is typically used in the United States.

By factory the amplitude of the frequency shifts is +10 KHz and the time lag of the code repeat is 60 minutes (for values different from these parameters, please contact R.V.R. Elettronica SpA). As regards the Radio code, it can be set by the user following the indications described in chapter 5.5.1.1.

The **selection screen**, in presence on FSK option, adds the indication to FSK submenu.

Menu 11

The pressure of **ENTER** button, on FSK entry in the **selection screen**, serves in order to access to all the relative submenu:

Menu12

FSK	Enable or disable the transmission of the FSK code.
Code	Visualization of the code normally transmitted.

5.5.1.1 Code Modification

In every moment the user is able to make changes to the Radio code transmitted in FSK.

In order to make the operation is necessary to have:

- 1 RS232 male - female cable;
- Hyper Terminal Interface (verify that it has been installed together to the own copy of Windows®) or equivalent serial communication software.

The procedure to execute comes shortly described in the following:

- Connect a standard serial cable (DB9 Male - DB9 Female) the **COM** serial port place on PC to **SERVICE** connector placed on the rear panel of the **TEX30-LCD**.
- Turn on the exciter;
- Start up the serial communication software;
- Set up the following parameters for the communication:

Baud Rate: 19200

Data Bit: 8

Parity: None

Stop Bit: 1

Flow control: None;

- Through the communication software activate the Caps-Lock key (capital), send the *CODE* string followed from the 6 characters of the station code and then confirm pressing Enter.



The code is considered only if is complete of 6 characters (alphanumeric and without spaces). In case the code is accepted, it comes repeated in echo towards the program, in contrary case the echo of the code does not come made.

5.5.2 UP/DOWN Power Option

The UP/DOWN Power modifies the function to receive signals present on the telemetry connector (see chap. 6.4.2).

In this particular situation the control signals uses to enable or to disable the RF section, become control signals of the RF power level, allowing one regulation of UP/DOWN type.

The UP or DOWN command is supplied connecting the relative signal on the Remote connector to the ground, at least for 500mS (the pin has an inner pull-up towards feeding).



This function is typically used in the United States.

Configuration of the telemetry DB15F connector (Remote):

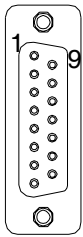

Pin	Standard Function	UP/DOWN Power Function
14	On cmd <i>Enables RF power supply</i>	Up cmd <i>Increases RFthe Power supply</i>
15	Off cmd <i>Disables RF power supply</i>	Down cmd <i>Reduces RFthe Power supply</i>

6. External Description

This chapter reports the elements of the front and rear panels of the with a brief description of each of them.

6.1 Front Panel

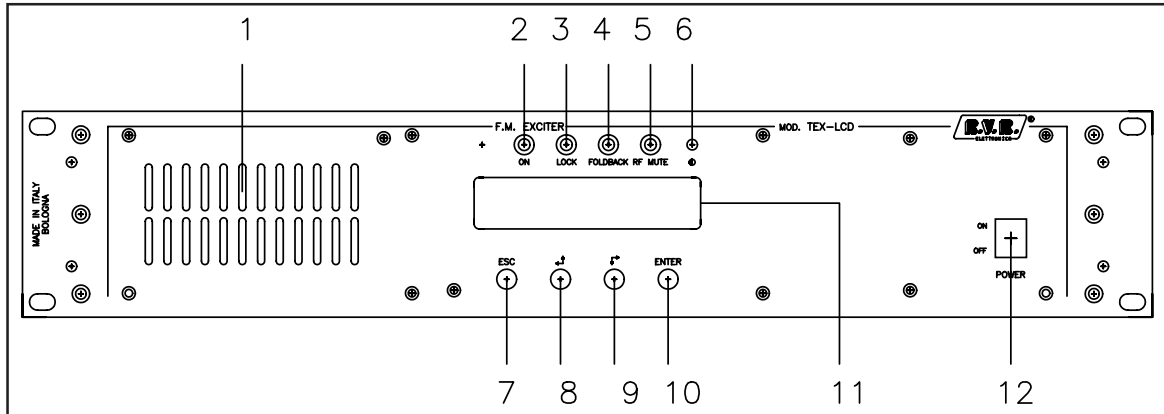

Figure 6.1

- | | |
|---------------|---|
| [1] AIR FLOW | Grid for the passage of the air flow of the forced ventilation |
| [2] ON | Green LED, lit when the exciter is working |
| [3] LOCK | Green led, lit when the PLL is locked on the working frequency |
| [4] FOLDBACK | Yellow LED, lit when the foldback function is operating (automatic reduction of the delivered RF power) |
| [5] R.F. MUTE | Yellow LED, lit when the exciter's power output is inhibited by an external interlock command |
| [6] CONTRAST | Display contrast adjusting trimmer |
| [7] ESC | Push button to exit from a menu |
| [8] | Push button to move in the menu system and to modify the parameters |
| [9] | Push button to move in the menu system and to modify the parameters |
| [10] ENTER | Push button to confirm a parameter and to enter in a menu |
| [11] DISPLAY | Liquid crystals display |
| [12] POWER | ON/OFF switch. This switch disables the exciter without disconnecting the mains supply |

6.2 Rear Panel

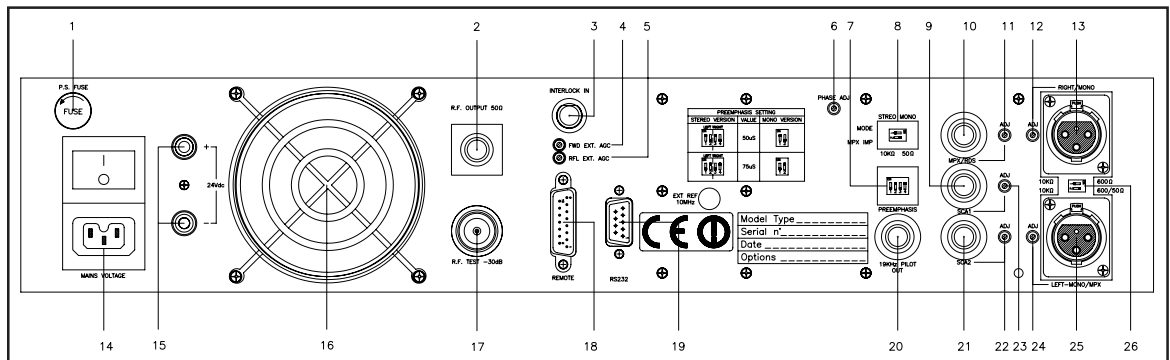

figure 6.2

- | | |
|------------------------|---|
| [1] FUSE BLOCK | Fuse carrier. Use a screwdriver to access the fuse. Contains the general protection fuse rated 3.15 A. |
| [2] R.F. OUTPUT | RF output connector, N-type, 50Ω. |
| [3] INTERLOCK | BNC interlock connector: the exciter is forced in stand-by mode when the inner conductor is grounded. |
| [4] FWD EXT. AGC | Trimmer for the control of the delivered power in function of the FWD fold input (see cap. 6.4.2). |
| [5] RFL EXT. AGC | Trimmer for the control of the delivered power in function of the RFL fold input (see cap. 6.4.2). |
| [6] PHASE ADJ | Pilot tone phase adjustment trimmer. |
| [7] PREENPHASIS | Dip-switch to set the preemphasis at 50 or 75 μs. The preemphasis setting is relevant only for the Left and Right inputs in stereo mode and for the mono input in mono mode, while MPX input is unaffected by this setting. |
| [8] MODE/MPX IMP | Dip-switch to set the operation mode (STEREO or MONO) and the MPX input impedance, 50Ω or 10kΩ. |
| [9] SCA 1 | BNC connector, SCA1 unbalanced input. |
| [10] MPX/RDS | BNC connector, MPX unbalanced input. |
| [11] MPX/RDS ADJ | Adjustment trimmer for MPX input. |
| [12] RIGHT/MONO ADJ | Adjustment trimmer for the Right channel input. |
| [13] RIGHT/MONO | XLR connector, balanced Right channel input. |
| [14] PLUG | Mains supply plug, 90 - 260V 50-60 Hz. |
| [15] 24VDC IN | External 24Vdc supply input. Positive (red) and negative (black). |
| [16] FAN | Fan for the forced ventilation of the exciter. |
| [17] R.F. TEST POINT | RF test output, approx. -30 dB wrt the RF output power level. |
| [18] REMOTE | DB15 connector for telemetry of the machine. |
| [19] RS232 | DB9 connector for interconnection with other devices and for factory parameters programming. |
| [20] 19 KHZ PILOT | BNC output for the 19 kHz pilot tone. This can be used for external devices (e.g. RDS coders) synchronization. |
| [21] SCA 2 | BNC connector, SCA2 unbalanced input. |
| [22] SCA2 ADJ | Adjustment trimmer for SCA2 input. |
| [23] SCA1 ADJ | Adjustment trimmer for SCA1 input. |
| [24] LEFT-MONO/MPX ADJ | Adjustment trimmer for Left-Mono channel input. |
| [25] LEFT-MONO/MPX | XLR connector, balanced Left-Mono channel input. |
| [26] IMPEDANCE | Dip-switch to set the balanced input impedance, 600Ω or 10kΩ. |

6.3 Connectors description

6.3.1 RS 232

Type: DB9 female

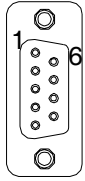

1	NC
2	TX_D
3	RX_D
4	Internally connected with 6
5	GND
6	Internally connected with 4
7	Internally connected with 8
8	Internally connected with 7
9	NC

6.3.2 Remote

Type: DB15 female

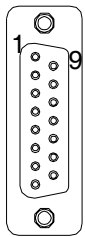

Pin	Name	Type	Meaning
1	Interlock	IN	By passes power if closed at GND
2	Ext AGC FWD	IN	Ext. signal for power limitation (AGC)
3	GND		Ground
4	SDA IIC	I/O	IIC communication serial data
5	VPA TIm	OUT anal.	PA power supply voltage 3,9V F.S.
6	FWD tIm	OUT anal.	Forward power 3,9V F.S.
7	Power Good	OUT digit.	Open collector, enabled when power exceeds the set threshold (par. 5.4.1)
8	GND		Ground
9	GND		Ground
10	Ext AGC RFL	IN	Ext. signal for power limitation (AGC)
11	SCL IIC	I/O	IIC communication clock
12	IPA TIm	OUT anal.	PA power supply current 3,9V F.S.
13	RFL TIm	OUT anal.	Reflected power 3,9V F.S.
14	On cmd	IN digit.	One grounded pulse (500 ms) enables power supply
15	Off cmd	IN digit.	One grounded pulse (500 ms) disables power supply

6.3.3 Left (MONO) / Right (MPX)

Type: XLR female



1	GND
2	Positive
3	Negative

7. Technical Specifications

7.1 Mechanical characteristics

Panel Size	483 mm (19") x 88 mm (2 HE)
Depth	355 mm
Weight	approx. 6,5 Kg
Working Temperature	-10 °C ÷ 50 °C, without condensing

7.2 Electrical characteristics

General

Output RF power	0-30 W adjustable with continuity
Frequency band	87.5MHz ÷ 108MHz, 10kHz step (it is possible to specify different steps when ordering)
Frequency programming	Direct via software
Frequency stability	±1ppm from -10°C to 50°C
Modulation type	Direct carrier modulation
Spurious and harmonic suppression	Complies with or exceeds FCC and CCIR standards < 75dBc (typical 80dBc)
Modulation capacity	Complies with or exceeds FCC and CCIR 180kHz MPX or Mono, 150 KHz Stereo
Residual asynchronous AM modulation	≥ 65dB or lower compared to 100% AM, without deemphasis (typical 70dB)
Residual synchronous AM modulation	≥ 50dB or lower compared to 100% AM, modulation FM 75 kHz at 400Hz, without deemphasis (typical 60dB)
DC power supply	24V _{DC}
DC Current	3,5A _{DC}
AC power supply connector	Standard IEC
AC power supply	80 ÷ 260 V ±15%
Power Factor	0.5
Apparent AC power consumption	120VA
Active power consumption	70W
Cooling	Forced, with internal fan
Acoustic disturbance	< 58dBA

Inputs

MPX/Left inputs	XLR female, externally balanced or unbalanced
Right input	XLR female, externally balanced or unbalanced
MPX/RDS input	Unbalanced BNC
SCA/RDS input	Unbalanced BNC
Input impedance	10kOhm or 600Ohm, XLR MPX/Left - Right 10kOhm or 50Ohm BNC MPX/RDS selectable via DIP-switch
Input level	-13dBu ÷ +13dBu, continuous fine adjustment with trimmer
Preemphasis	Selectable: 0 50 us (CCIR) 75 us (FCC)
SCA/RDS inputs	Unbalanced BNC
SCA/RDS input impedance	10 kOhm
SCA/RDS input level	-8dBu ÷ +13dBu, continuous fine adjustment with trimmer

Outputs

RF Out	N-type female connector
Output Impedance	50 Ohm
RF Test	BNC connector
Ou	50 Ohm
Output level	level -60dB compared to RF output
19kHz Out	BNC female connector for isofrequency and RDS synchronization
Output Impedance	>5 kOhm
19 KHz pilot tone	1 Vpp

MONO Operations

S/N FM	> 80dB (typical 85dB) compared to ± 75 kHz peak, measured in the 20Hz \div 23kHz band with 50 us deemphasis, RMS detector > 73dB compared to ± 75 kHz peak, CCIR not weighed with 50 us deemphasis, Qpk detector > 68dB compared to ± 40 kHz peak, CCIR weighed with 50 us deemphasis, Qpk detector
Amplitude/frequency response	better than ± 0.5 dB (typical ± 0.2 dB), 30Hz \div 15Khz
Total Harmonic Distortion (THD)	< 0.1% (typical 0.07%), THD+N 30Hz \div 15Khz
Intermodulation distortion	< 0.02%, measured with 1KHz and 1.3KHz tones, 1:1 ratio, at 75KHz
Transient intermodulation distortion	< 0.1% (typical 0.05%), measured with 3.18KHz square wave and 15KHz sinusoidal wave, at 75KHz

MPX Operations

S/N FM	> 80dB (typical 85dB) compared to ± 75 kHz peak, measured in the 20Hz – 100kHz band with 50 us deemphasis, RMS detector
Amplitude/frequency response	± 0.2 dB, 30Hz \div 53Khz ± 0.5 dB, 30Hz \div 100Khz
Total Harmonic Distortion (THD)	< 0.1%, 30Hz \div 53Khz < 0.15%, 30Hz \div 100Khz
Intermodulation distortion	< 0.05%, measured with 1KHz and 1.3KHz tones, 1:1 ratio, at 75KHz
Transient intermodulation distortion	< 0.1% (typical 0.05%), measured with 3.18KHz square wave 15KHz sinusoidal wave, at 75KHz
Stereo separation	> 50 dB (typical 60dB), 30Hz \div 53Khz

Stereo operation

S/N FM	> 75dB (typical 78dB) compared to ± 75 kHz peak, measured in the 20Hz \div 23kHz band with 50 us deemphasis, demodulated L&R, RMS detector > 65dB compared to ± 75 kHz peak, CCIR not weighed with 50 us deemphasis, demodulated L&R, Qpk detector > 58dB compared to ± 40 kHz peak, CCIR weighed with 50 us deemphasis, demodulated L&R, Qpk detector
--------	--

Amplitude/frequency response	$\pm 0.5\text{dB}$, 30Hz ÷ 15Khz
Total Harmonic Distortion (THD)	< 0.05%, THD+N 30Hz ÷ 15Khz
Intermodulation distortion	$\leq 0.03\%$, measured with 1KHz and 1.3KHz tones, 1:1 ratio, at 75KHz
Transient intermodulation distortion	< 0.1% (typical 0.05%), measured with 3.18KHz square wave and 15KHz sinusoidal wave, at 75KHz
Stereo separation	> 50 dB (typical 55 dB)
Main/Sub ratio	> 40 dB (typical 45 dB)

SCA operation

Amplitude/frequency response	$\pm 0.5\text{dB}$, 40Hz ÷ 100Khz
Main or stereo channel diaphony	> 75 dB (typical 78 dB) compared to $\pm 75\text{kHz}$ peak, measured in the entire band with 0 us deemphasis, with 67KHz tone on SCA input, at 7.5KHz deviation > 78 dB (typical 80 dB) compared to $\pm 75\text{kHz}$ peak, measured in the entire band with 0 us deemphasis, with 92KHz tone on SCA input, at 7.5KHz deviation

Auxiliary connections

Interlock	2 BNC female connectors: by grounding the central conductor the transmitter is forced in stand-by mode.
Ext. ref. 10MHz	SMA
RS232	DB9 female
Service	DB9 female
I ² C Bus	DB9 female
Modem	DB9 female
Remote interface	DB15 female, provides indications on the condition of the machine

Options

/10MHZ	10MHz input
--------	-------------

7.3 Spare Parts

Subset for the Maintenance

Panel Board	SL007PC2001
Power Supply	FLY100SMD
Main Board	SLMBDTEXLC04
Stereo Coder CTC30	SLCTC30V03
Control Board	SL037BI1001
RF Module	SLPA30WMOS01
Telemetry Board	SLTLMTXLCD03

Components Kit for the Maintenance

Front Panel Kit version 04	KPANTEX30L04
Main block Kit version 04	KMBDTEXLC04
Final TEX30-LCD Kit	KPA30WMOS01

Use Parts

Fan	VTL8414
-----	---------

8. Working Principles

A schematic view of the modules and connections making up the **TEX30-LCD** with the telemetry board is shown in figure 8.1.

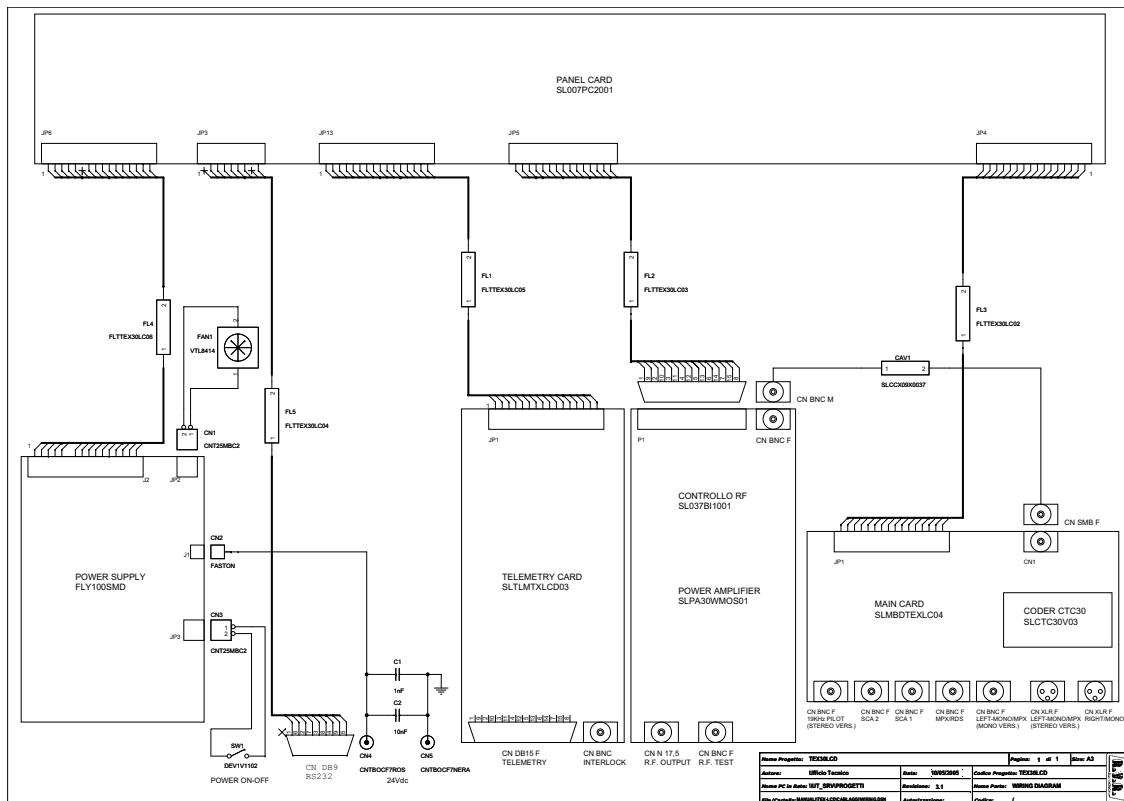

Figure 8.1

A brief description of each module's functions is given below, whereas the complete diagrams and layout of the cards are given in the appendix.

8.1 Power Supply

The **TEX30-LCD/S** power supply unit is a switching-type unit whose +28 V main output powers the machine's RF amplifier. The power supply also features stabilizers for generating continuous +5 V and +18 V voltages for supplying the other equipment circuits. Note that the power supply is a "direct from mains" type, or rather it is without a transformer, and it can be connected to any voltage between 80 and 260 V without any adjustments or manual settings. The power supply unit is also connected to 24 V auxiliary continuous voltage inputs used to automatically buffer the mains power cutoff.

8.2 Panel board

The panel board contains the microcontroller (PIC18F452) that implements the equipment control software, the display and the other components needed to interface with the user.

The board is connected with the other machine modules, both for power supply distribution and for the control and measures.

8.3 Main board

The main board carries out the following functions:

- Audio and SCA input treatment
- Generation of carrier frequency
- Modulation
- R.F. amplification (Driver)

The board also features a stereophonic coder.

8.3.1 Audio input section

The audio input section contains the circuits that perform the following functions:

- Input impedance selection
- 15 kHz filtering of the left and right channel
- Stereophonic Coding
- Mono channel preemphasis
- Mono, MPX and SCA channel mixing
- Clipper (limits the modulating signal level so that the frequency deviation does not exceed 75 kHz)
- Modulating signal measurement

8.3.2 PLL/VCO section

This board section generates the modulated radiofrequency signal. It is based on a PLL scheme that uses an integrated MB15E06 type.

8.3.3 Driver section

Before passing to the final power amplifier, the RF signal is preamplified in this section by an ERA3 transistor. When the exciter is placed on stand-by, the driver is bypassed.

8.4 Power Amplifier

The final power stage is enclosed in a totally shielded metal container fixed to the central part of the device.

The RF signal coming from the main board reached the pilot, it come amplified and sent to the final stage which takes care of final amplification up to 30W.

The amplifier is made in three stages. The first is made with one BFG35, the second with three BFG35 in parallel, and the last with one BLF245.

In addition to the actual RF amplification, this circuit carries out the following functions:

- Control of the power level in output, depending on the setting
- Reduction of the power supplied when in presence of high-level reflected power
- Measures of the forward and reflected power by means of directional couplers
- Measures of the current absorbed by the power amplifier
- Measures of the temperature
- Low-pass filtering of the RF signal in output

This board also features an RF sampling of approximately -30dB RF with respect to the output, which is available on a BNC connector below the transmitter output connector. This sample is useful for verifying the characteristics of the carrier, but not for verifying those of the upper harmonics.

8.5 Control Board

The main function of this board is to check and correct the MOSFET polarization voltage of the RF amplifier section.

It also provides the measurement of the absorbed current and contains a circuit for signaling power supply unit faults.

If no alarms are present, the voltage is adjusted only depending on the set output power, with a feedback mechanism based on the reading of the power really delivered (AGC).

The voltage is also affected by other factors, such as:

- Excess of reflected power.
- External AGC signals (Ext. AGC FWD, Ext. AGC RFL).
- Excess of temperature.
- Excess of absorbed current from the RF module.

8.6 Telemetry board

This board is designed to inform the user of the equipment operation state. All input and output signals are available on the DB15 connector.

The same board also features the “INTERLOCK” BNC connector for disabling the device. By grounding the central pin, the output power is reduced to zero until the connection is removed.

When an R.V.R. amplifier is used, this connector is linked to the power amplifier REMOTE or INTERLOCK by means of a BNC-BNC connection. In case of amplifier faults, the central conductor is grounded thus forcing the machine to enter in stand-by mode.

9. Identification and Access to the Modules

9.1 Identification of the Modules

The **TEX30-LCD** is made up of various modules linked to each other through connectors so as to make maintenance and any required module replacement easier.

9.1.1 Upper view

The figure below shows the equipment upper view with the various components pointed out.

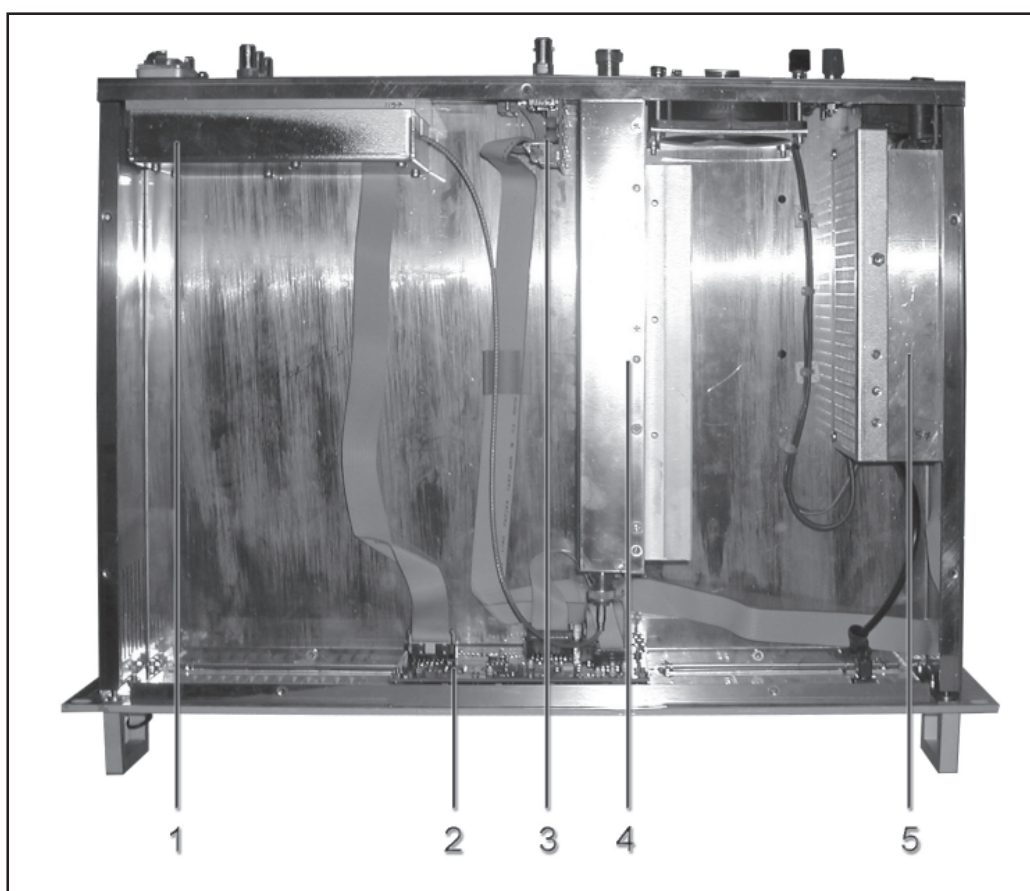

figura 8.1

- [1] Main Board (*SLMBDTEXLC04*)
- [2] Panel Board (*SL007PC2001*)
- [3] Telemetry Board (*SLTLMTXLCD03*)
- [4] Control e RF Modulo Board (*SL037BI1001* e *SLPA30WMOS01*)
- [5] Power Supply (*FLY100SMD*)