



PJ300C-LCD

USER MANUAL
VOLUME 1



File Name: PJ300C-LCD_ING_1.2.indb

Version: 1.2

Date: 17/02/2016

Revision History

Date	Version	Reason	Editor
15/12/2006	1.0	First Version	J. H. Berti
06/04/2012	1.1	Minor updates	J. H. Berti
17/02/2016	1.2	Menu updates	J. H. Berti

PJ300C-LCD - User Manual
Version 1.2

© Copyright 2006-2016
R.V.R. Elettronica SpA
Via del Fonditore 2/2c - 40138 - Bologna (Italia)
Telephone: +39 051 6010506
Fax: +39 051 6011104
Email: info@rvr.it
Web: www.rvr.it

All rights reserved
Printed and bound in Italy. No part of this manual may be reproduced, memorized or transmitted in any form or by any means, electronic or mechanic, including photocopying, recording or by any information storage and retrieval system, without written permission of the copyright owner.

Notification of intended purpose and limitations of product use

This product is a FM transmitter intended for FM audio broadcasting. It utilises operating frequencies not harmonised in the intended countries of use. The user must obtain a license before using the product in intended country of use. Ensure respective country licensing requirements are complied with. Limitations of use can apply in respect of operating frequency, transmitter power and/or channel spacing.

Declaration of Conformity

Hereby, R.V.R. Elettronica SpA, declares that this FM transmitter is in compliance with the essential requirements and other relevant provisions of Directive 1999/5/EC.



Table of Contents

1.	Preliminary Instructions	1
2.	Warranty	1
3.	First Aid	2
3.1	Treatment of electrical shocks	2
3.2	Treatment of electrical Burns	2
4.	General Description	3
4.1	Unpacking	3
4.2	Features	3
4.3	Frontal Panel Description	5
4.4	Rear Panel Description	6
4.5	Connectors Description	7
4.6	Technical Description	9
5.	Quick guide for installation and use	10
5.1	Preparation	10
5.2	First power-on and setup	12
5.3	Operation	14
5.4	Management Firmware	15
6.	Identification and Access to the Modules	23
6.1	Identification of the Modules	23
7.	Working Principles	24
7.1	Panel Board	24
7.2	Telemetry Board	24
7.3	Power Supply	24
7.4	Power Amplifier	24
7.5	Control Board	24

This page was intentionally left blank

IMPORTANT



The symbol of lightning inside a triangle placed on the product, evidences the operations for which is necessary gave it full attention to avoid risk of electric shocks.



The symbol of exclamation mark inside a triangle placed on the product, informs the user about the presence of instructions inside the manual that accompanies the equipment, important for the efficacy and the maintenance (repairs).

1. Preliminary Instructions

• General Warnings

This equipment should only be operated, installed and maintained by "trained" or "qualified" personnel who are familiar with risks involved in working on electric and electronic circuits. "Trained" means personnel who have technical knowledge of equipment operation and who are responsible for their own safety and that of other unqualified personnel placed under their supervision when working on the equipment. "Qualified" means personnel who are trained in and experienced with equipment operation and who are responsible for their own safety and that of other unqualified personnel placed under their supervision when working on the equipment.

 **WARNING: Residual voltage may be present inside the equipment even when the ON/OFF switch is set to Off. Before servicing the equipment, disconnect the power cord or switch off the main power panel and make sure the safety earth connection is connected. Some service situations may require inspecting the equipment with live circuits. Only trained and qualified personnel may work on the equipment live and shall be assisted by a trained person who shall keep ready to disconnect power supply at need.**

R.V.R. Elettronica S.p.A. shall not be liable for injury to persons or damage to property resulting from improper use or operation by trained/untrained and qualified/unqualified persons.

 **WARNING: The equipment is not water resistant. Any water entering the enclosure might impair proper operation. To prevent the risk of electrical shock or fire, do not expose this equipment to rain, dripping or moisture.**

Please observe local codes and fire prevention rules when installing and operating this equipment.

 **WARNING: This equipment contains exposed live parts involving an electrical shock hazard. Always disconnect power supply before removing any covers or other parts of the equipment.**

Ventilation slits and holes are provided to ensure reliable operation and prevent overheating; do not obstruct or cover these slits. Do not obstruct the ventilation slits under any circumstances. The product must not be incorporated in a rack unless adequate ventilation is provided or the manufacturer's instructions are followed closely.

 **WARNING: This equipment can radiate radiofrequency energy and, if not installed in compliance with manual instructions and applicable regulations, may cause interference with radio communications.**

 **WARNING: This equipment is fitted with earth connections both in the power cord and for the chassis. Make sure both are properly connected.**

Operation of this equipment in a residential area may cause radio interference, in which case the user may be required to take adequate measures.

The specifications and data contained herein are provided for information only and are subject to changes without prior notice. R.V.R. Elettronica S.p.A. disclaims all warranties, express or implied. While R.V.R. Elettronica S.p.A. attempts to provide accurate information, it cannot accept responsibility or liability for any errors or inaccuracies in this manual, including the products and the software described herein. R.V.R. Elettronica S.p.A. reserves the right to make changes to equipment design and/or specifications and to this manual at any time without prior notice.

• Notice concerning product intended purpose and use limitations.

This product is a radio transmitter suitable for frequency-modulation audio radio broadcasting. Its operating frequencies are not harmonised in designated user countries. Before operating this equipment, user must obtain a licence to use radio spectrum from the competent authority in the designated user country. Operating frequency, transmitter power and other characteristics of the transmission system are subject to restrictions as specified in the licence.

2. Warranty

La R.V.R. Elettronica S.p.A. warrants this product to be free from defects in workmanship and its proper operation subject to the limitations set forth in the supplied Terms and Conditions. Please read the Terms and Conditions carefully, as purchase of the product or acceptance of the order acknowledgement imply acceptance of the Terms and Conditions. For the latest updated terms and conditions, please visit our web site at WWW.RVR.IT. The web site may be modified, removed or updated for any reason whatsoever without prior notice. The warranty will become null and void in the event the product enclosure is opened, the product is physically damaged, is repaired by unauthorised persons or is used for purposes other than its intended use, as well as in the event of improper use, unauthorised changes or neglect. In the event a defect is found, follow this procedure:

- 1 Contact the seller or distributor who sold the equipment; provide a description of the problem or malfunction for the event a quick fix is available.

Sellers and Distributors can provide the necessary information to troubleshoot the most frequently encountered problems. Normally, Sellers and Distributors can offer a faster repair service than the Manufacturer would. Please note that Sellers can pinpoint problems due to wrong installation.

- 2 If your Seller cannot help you, contact R.V.R. Elettronica S.p.A. and describe the problem; if our staff deems it appropriate, you will receive an authorisation to return the equipment along with suitable instructions;
- 3 When you have received the authorisation, you may return the unit. Pack the unit carefully before shipment; use the original packaging whenever possible and seal the package perfectly. The customer bears all risks of loss (i.e., R.V.R. shall not be liable for loss or damage) until the package reaches the R.V.R. factory. For this reason, we recommend insuring the goods for their full value. Returns must be sent on a C.I.F. basis (PREPAID) to the address stated on the authorisation as specified by the R.V.R. Service Manager.



Units returned without a return authorisation may be rejected and sent back to the sender.

- Be sure to include a detailed report mentioning all problems you have found and copy of your original invoice (to show when the warranty period began) with the shipment.

Please send spare and warranty replacement parts orders to the address provided below. Make sure to specify equipment model and serial number, as well as part description and quantity.



R.V.R. Elettronica S.p.A.
Via del Fonditore, 2/2c
40138 BOLOGNA ITALY
Tel. +39 051 6010506

3. First Aid

All personnel engaged in equipment installation, operation and maintenance must be familiar with first aid procedures and routines.

3.1 Electric shock treatment

3.1.1 If the victim is unconscious

Follow the first aid procedures outlined below.

- Lay the victim down on his/her back on a firm surface.
- the neck and tilt the head backwards to free the airway system (**Figure 1**).

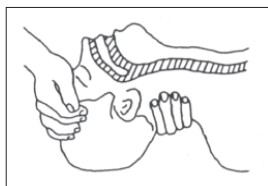

Figure 1

- If needed, open the victim's mouth and check for breathing.
- If there is no breathing, start artificial respiration without delay (**Figure 2**) as follows: tilt the head backwards, pinch the nostrils, seal your mouth around the victim's mouth and give four fast rescue breaths.



Figure 2

- Check for heartbeat (**Figure 3**); if there is no heartbeat, begin chest compressions immediately (**Figure 4**) placing your hands in the centre of the victim's chest (**Figure 5**).

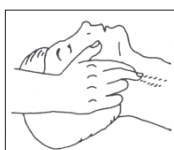

Figure 3

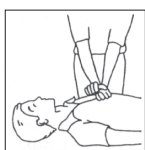

Figure 4

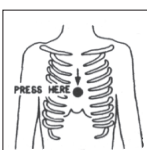

Figure 5

- One rescuer: give 2 quick rescue breaths after each 15 compressions.
- Two rescuers: one rescue breath after each 5 compressions.

- Do not stop chest compressions while giving artificial breathing.
- Call for medical help as soon as possible.

3.1.2 If the victim is conscious

- Cover victim with a blanket.
- Try to reassure the victim.
- Loosen the victim's clothing and have him/her lie down.
- Call for medical help as soon as possible.

3.2 Treatment of electric burns

3.2.1 Large burns and broken skin

- Cover affected area with a clean cloth or linen.
- Do not break any blisters that have formed; remove any clothing or fabric that is stuck to the skin; apply adequate ointment.
- Administer adequate treatment for the type of accident.
- Get the victim to a hospital as quickly as possible.
- Elevate arms and legs if injured.

If medical help is not available within an hour, the victim is conscious and is not retching, administer a solution of table salt and baking soda (one teaspoon of table salt to half teaspoon of baking soda every 250 ml of water).

Have the victim slowly drink half a glass of solution for four times during a period of 15 minutes.

Stop at the first sign of retching.

Do not administer alcoholic beverages.

3.2.2 Minor burns

- Apply cold (not ice cold) strips of gauze or dress wound with clean cloth.
- Do not break any blisters that have formed; remove any clothing or fabric that is stuck to the skin; apply adequate ointment.
- If needed, have the victim change into clean, dry clothing.
- Administer adequate treatment for the type of accident.
- Get the victim to a hospital as quickly as possible.
- Elevate arms and legs if injured.

4. General Description

The **PJ300C-LCD** is an **radio broadcasting amplifier** manufactured by **R.V.R. Elettronica SpA** featuring adjustable RF power output up to 300 W under 50 Ohm standard load and less than 10 W drive power requirement.

The **PJ300/502/702C-LCD** are designed to being contained into a 19" rack box of 2HE.

4.1 Unpacking

The package contains:

- 1 **PJ300C-LCD**
- 1 User Manual
- 1 Mains power cables

The following accessories are also available from Your R.V.R. Dealer:

- **Accessories, spare parts and cables**

4.2 Features

The amplifier incorporates a low-pass filter to keep harmonics below the limits provided for by international standards (CCIR, FCC or ETSI).



Two major features of **PJ300C-LCD** are compact design and user-friendliness. Another key feature is its modular-concept design: the different functions are performed by modules with most connections achieved through male and female connectors or through flat cables terminated by connectors. This design facilitates maintenance and module replacement.

The RF power section uses one MOSFET module (SD2932) able to deliver over 300W depending the version.

An LCD on the front panel and a push-button panel provide for user interfacing with the microprocessor control system, which implements the following features:

- Output power setup.
- Power output enable/disable.
- User-selectable threshold settings for output power alarm (Power Good feature)
- Measurement and display of amplifier operating parameters.
- Communication with external devices such as programming or telemetry systems via RS232 serial interface or I²C.



Four LEDs on the front panel provide the following status indications: **ON**, **FAULT**, **FOLDBACK** and **RF MUTE**.

The amplifier management firmware is based on a menu system. User has four navigation buttons available to browse submenus: **ESC** ,  ,  , and **ENTER**.

The rear panel features the mains input connectors, RF power input and output connectors, remote connector, protection fuse, interlock input and interlock output connectors and a BNC connector that provides an RF test point with level being 13 dBm \pm 6dB lower than power output.

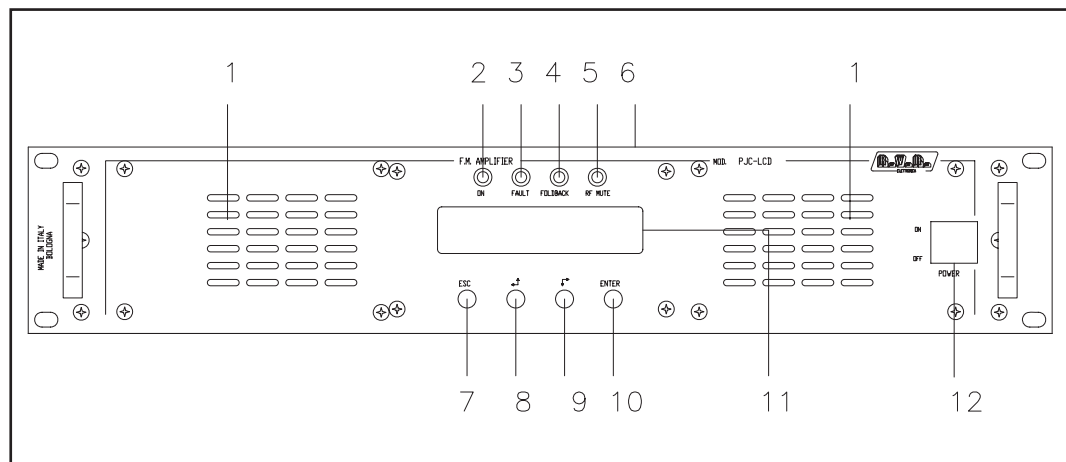
4.3 Frontal Panel Description



- | | |
|---|--|
| [1] AIR FLOW | Air flow for the forced ventilation. |
| [2] ON | Green LED, lit when the amplifier is working. |
| [3] FAULT | Red led, lit when the machine is in permanent fault lock-out mode. |
| [4] FOLDBACK | Yellow LED, lit when the foldback current limiting (Automatic Gain Control) is intervened |
| [5] R.F. MUTE | Yellow LED, lit when the amplifier's power output is inhibited by an external interlock command. |
| [6] CONTRAST | Display contrast adjusting trimmer (on the top of the equipment). |
| [7] ESC | Press button to exit from a menu. |
| [8]  | Press button to move in the menu system and to modify the parameters. |
| [9]  | Press button to move in the menu system and to modify the parameters. |
| [10] ENTER | Press button to confirm a parameter and to enter in a menu. |
| [11] DISPLAY | Liquid Crystals Display. |
| [12] POWER | AC mains ON/OFF switch. |

4.4 Rear Panel Description

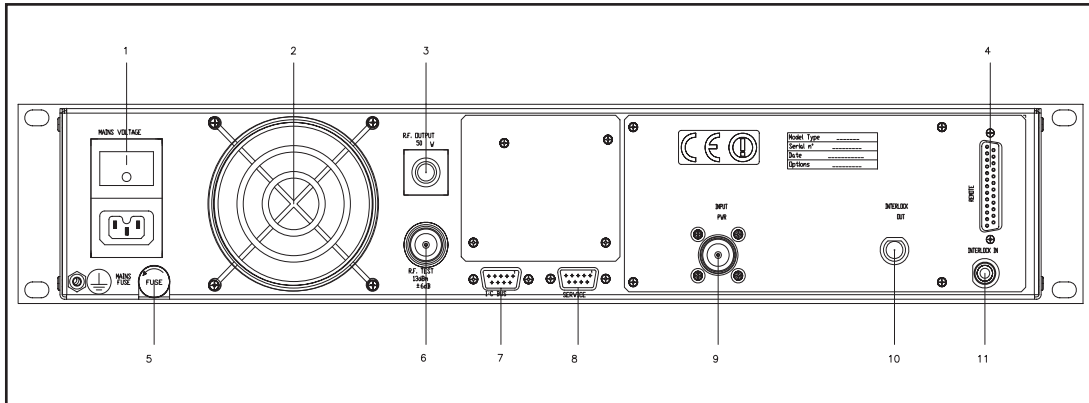

- | | |
|---|---|
| <p>[1] PLUG
[2] FAN
[3] R.F. OUTPUT
[4] REMOTE
[5] FUSE BLOCK</p> <p>[6] R.F. TEST</p> <p>[7] I²C BUS
[8] SERVICE</p> <p>[9] INPUT PWR
[10] INTERLOCK OUT</p> <p>[11] INTERLOCK IN</p> | <p>VDE plug for mains supply, 80 - 260V 50-60 Hz.</p> <p>Fan for the forced ventilation of the amplifier.</p> <p>RF output connector, N-type, 50Ω.</p> <p>DB25 connector for telemetry of the machine.</p> <p>Fuse carrier. Use a screwdriver to access the fuse. Contains the general protection fuse rated 8AT 5x20.</p> <p>RF test output, approx. 13 dBm wrt the RF output power level</p> <p>DB9 connector for I²C bus networking.</p> <p>DB9 connector for interconnection with other devices and for factory parameters programming (only for factory programming).</p> <p>RF input connector, N-type, 50Ω.</p> <p>Interlock output BNC connector: to inhibit an external device, as an exciter. In case of fault, the inner connector is shorted to ground.</p> <p>Interlock input BNC connector: to inhibit the amplifier from an external device, like an exciter.</p> |
|---|---|

4.5 Connectors Description

4.5.1 Remote

Type: Female DB25

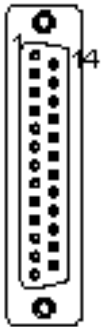

1	NC	
2	RF power amplifier voltage	3,9V x 40V
3	GND	GND
4	Reflected Power	3.9V x 30W
5	Interlock Out	Signals the activation by grounding the contact normally open
6	NC	
7	GND	GND
8	“On” Command	A pulse to ground (500 ms) delivers power output
9	Set 1 (FWD Power Good 1)	
10	WAIT	Signals the activation by grounding the contact normally open
11	Reset alarm	
12	OFF	A pulse to ground (500 ms) indicates the inhibit of power output
13	Interlock	Signals the activation by grounding the contact normally open
14	NC	
15	RF power amplifier current	3.9V x 10 A
16	Forward Power	3.9V x 300W
17	FAULT	Signals the activation by grounding the contact normally open
18	Set 3 (RFL Power Good 3)	
19	NC	
20	“OFF” Command	A pulse to ground (500 ms) inhibits power output
21	GND	GND
22	Set 2 (FWD Power Good 2)	
23	LOC	Signals the activation by grounding the contact normally open
24	+Vcc	
25	ON	A pulse to ground (500 ms) indicates the deliver of power output

4.5.2 I²C Bus

Type: Male DB9

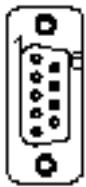

1	NC	
2	SDA	Serial DATA
3	SCL	Serial CLOCK
4	NC	
5	GND	GND
6	NC	
7	NC	
8	NC	
9	NC	

4.5.3 Service (for programming of factory parameters)

Type: Female DB9

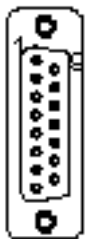

1	NC
2	TX_D
3	RX_D
4	Internally connected with 6
5	GND
6	Internally connected with 4
7	Internally connected with 8
8	Internally connected with 7
9	NC

4.6 Technical Description

		PJ300C-LCD		
Parameters	Conditions	U.M.		
GENERALS				
Frequency range		MHz	87.5 ÷ 108	
Rated output power		W	300	
Input power for rated output		W	10	
Power supply type			Mono phase	
AC Supply Voltage	Mains input voltage range	VAC	230 ±15%	
DC Supply Voltage	CPU backup Input Voltage	VDC		
AC Apparent Power Consumption		VA	540	
Active Power Consumption		W	500	
RF Fan active Power consumption		W	13	
RF module efficiency		%	65	
Overall efficiency		%	58	
Input device			4 pushbutton	
Display			Alphanumeric LCD - 2 x 16	
Overall Physical Dimensions	Front panel width	mm	483	
	Front panel height	HE	2	
	Overall depth	mm	370	
Ambient working temperature		°C	0 to + 50 (operational -10)	
Spurious & harmonic suppression		dBc	>70 (75 typical)	Meets or exceeds all FCC and CCR rules
RF INPUT				
RF Input	Connector		N type	
	Impedance	Ohm	50	
Driver power for rated output		W	11	
Max input power before protection		W	20	
RF OUTPUTS				
RF Output	Connector		N female type	
	Impedance	Ohm	50	
RF Monitor	Connector		BNC	
	Impedance	Ohm	50	
	Output Level	dB	13 +\-6 dBm	Referred to the RF output
AUXILIARY CONNECTIONS				
Interlock Input	Connector		BNC	For remote power inhibition (short is RF off)
Interlock Output	Connector		BNC	For remote power inhibition (short is RF off)
RS232 Serial Interface	Connector			
Service	Connector		DB9 F	Factory reserved for firmware program
I ² Cbus	Connector		DB9 F	
Modem	Connector			
RS485 Serial Interface	Connector			
Remote Interface	Connector			
Telemetry Interface	Connector		DB25F	
POWER REQUIREMENTS				
AC Power Input	AC Supply Voltage	VAC	80 ÷ 260 (*)	(*) Full range (**) Internal switch
	AC Apparent Power Consumption	VA	540	
	Active Power Consumption	W	500	
	Power Factor		0,93	
	Connector		VDE male	
DC Power Input	DC Supply Voltage	VDC		
	DC Current	ADC		
FUSES				
On Mains			1 External fuse F 8 T - 5x20 mm	
On services				
On PA Supply				
On Aux VDE socket				
MECHANICAL DIMENSIONS				
Physical Dimensions	Front panel width	mm	483 (19")	19" EIA rack
	Front panel height	mm	88(xxx")	
	Overall depth	mm	390	
	Chassis depth	mm	370 (xxxx)	
Weigh		kg	about 6	
OPTIONS				
		code		
		code		
TELEMETRY / TELECONTROL				
Telemetry connector inputs	Pulse		Command ON	
	Pulse		Command OFF	
	Pulse		Alarm Reset	
Remote connector outputs	Analogical level		FWD power	
	Analogical level		REF power	
	Analogical level			
	Analogical level			
	Analogical level		VPA	
	Analogical level		IPA	
	Analogical level			
	Open Collector		Status ON	
	Open Collector		Status OFF	
	Open Collector		Power Good 1	
	Open Collector		Power Good 2	
	Open Collector			
	Open Collector		Wait	
Open Collector		Fault		
Open Collector		Local		
ON / OFF level		Interlock		
Remote connector others			I2Cbus	
VARIOUS				
Cooling type			Forced, with internal fan	
Potenza dissipata in calore		W	150	
Acoustic Noise		dBA	<75	Leq 3 min @ 1 m
STANDARD COMPLIANCE				
Safety			EN60215:1989	
EMC			EN 301 489-11 V1, 2, 1	
Spectrum Optimization				

5. Quick guide for installation and use

This section provides a step-by-step description of equipment installation and configuration procedure. Follow these procedures closely upon first power-on and each time any change is made to general configuration, such as when a new transmission station is added or the equipment is replaced.

Once the desired configuration has been set up, no more settings are required for normal operation; at each power-up (even after an accidental shutdown), the equipment defaults to the parameters set during the initial configuration procedure.

The topics covered in this section are discussed at greater length in the next sections, with detailed descriptions of all hardware and firmware features and capabilities. Please see the relevant sections for additional details.



IMPORTANT: *When configuring and testing the transmitter in which the equipment is integrated, be sure to have the Final Test Table supplied with the equipment ready at hand throughout the whole procedure; the Final Test Table lists all operating parameters as set and tested at the factory.*

5.1 Preparation

5.1.1 Preliminary checks

Unpack the amplifier and immediately inspect it for transport damage. Ensure that all connectors are in perfect condition.

The main fuse can be accessed from the outside on the rear panel. Extract the fuse carrier with a screwdriver to check its integrity or for replacement, if necessary.

The following fuses are used:

	@ 230Vac and @ 115 Vac
Main Fuse <i>(fig. 6.2 - item [9])</i>	8A-T type 5x20

Table 5.1: Fuse

The main power supply unit is the full-range type and requires no voltage setup.

Provide for the following (applicable to operating tests and putting into service):

- √ Single-phase 230 VAC or 115VAC (-15% / +10%) mains power supply with adequate earth connection.
- √ For operating tests only: dummy load with 50 Ohm impedance and adequate capacity (300W for **PJ300C-LCD** as a minimum).

- √ Connection cable kit including:
 - Mains power cable.
 - Coaxial cable with BNC connectors for interlock signal connection between exciter and amplifier.
 - RF cable for output to load / antenna (50 Ohm coaxial cable with N-type connector).

5.1.2 Connections

Connect the output of a suitable FM exciter (for instance, TEX30LCD exciter available from R.V.R. Elettronica) to the RF input using a 50 Ohm coaxial cable with “N”-type connectors. To begin with, set exciter to minimum output power and switch it off.

Connect the amplifier INTERLOCK OUT output to the matching INTERLOCK IN input fitted on all R.V.R. Elettronica exciters as standard; if your exciter is a different brand, identify an equivalent input.

Connect the RF output to an adequately rated dummy load or to the antenna.

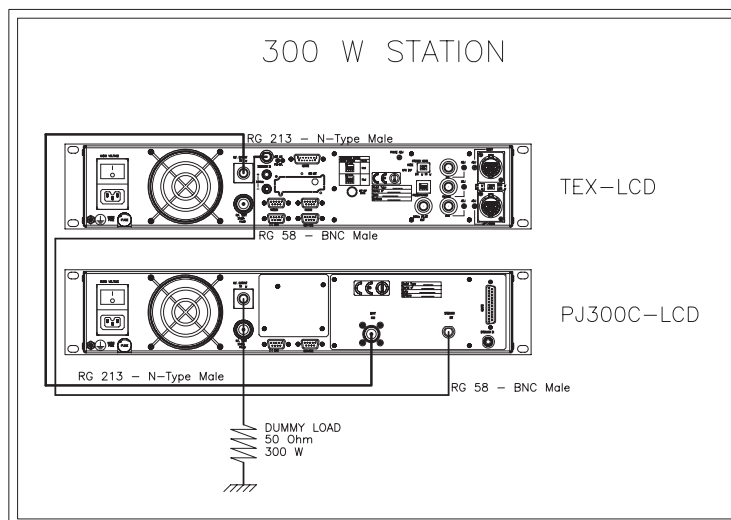

Figure 5.2: connections with amplifier



WARNING: Electric shock hazard! Never handle the RF output connector when the equipment is powered on and no load is connected. Injury or death may result.

Ensure that the **POWER** switch on the front panel is set to “**OFF**”.

Connect the mains power cable to the MAINS terminal board on the rear panel.



Note : The mains must be equipped with adequate ground connection properly connected to the machine. This is a pre-requisite for ensuring operator safety and correct operation.



WARNING: The power supply connector is a terminal board. Ensure the wire is not live before performing the connection.

5.2 First power-on and setup

Follow this procedure upon first power-on and after making changes to the configuration of the transmitter in which the amplifier is integrated.



Note : Standard factory settings are RF output power off (**Pwr OFF**) and regulated output power set to upper limit (unless otherwise specified by customer).

5.2.1 Pilot exciter setup

Set up the pilot exciter so that the output power it delivers to a matched load equals the maximum input power indicated in the amplifier **final test table**, switch off the exciter and connect it to the amplifier.

5.2.2 Power-on

When you have performed all of the connections described in the previous paragraph, power on the amplifier using the suitable power switch on the front panel. Power on the pilot exciter.

5.2.3 Power check

Ensure that the **ON** light turns on. Machine name should appear briefly on the display, quickly followed by forward and reflected power readings (figure 5.2 - menu 1). If RF output is disabled, these readings will be zero.

5.2.4 How to enable the RF output

Check current mode setting and enable **Local mode** (if not already enabled) following menu path **Fnc** ⇒ **Loc** ⇒ **Local** (figure 5.2): if left disabled, the machine will not accept the next commands.

Check current **RF** output setting and enable output (if not already enabled) following menu path **Fnc** ⇒ **Pwr** ⇒ **ON** (figure 5.2 - menu 4).

Check output power level and set to maximum level (if not already set to maximum) from the Power Setup Menu, which you can call up by pressing these keys in the order: **ESC** (opens **Default Menu**) ⇒ **ENTER** (hold down for 2 seconds) ⇒ **SET** ⇒ use key to set bar to maximum limit (figure 5.2 - menu 2).



5.2.5 RF output power level control



IMPORTANT: *The amplifier incorporates Automatic Gain Control and output power is modulated based on the power level set by the user and actual operating conditions, such as temperature, reflected power and other parameters. Drive power must be kept steady at maximum output power capacity. Please read section 5.3 for more details of RF power modulation.*

Open the **Power setup menu** (figure 5.2 - menu 2) pressing the following keys in the order:

ESC (opens **Default Menu**) ⇒ **ENTER** (hold down for 2 seconds)

Use **SET** menu  and  keys to set the desired amplifier output power; the SET bar at the side provides a graphic display of set power, whereas the forward power value shown on the display (**Fwd: xxxx W**) gives actual output power reading, **and may be lower than set power if an Automatic Gain Control is in limited-power mode** (please read section 5.3 concerning RF power modulation for more details”.



Note : *Output power can also be set in a **Pwr OFF** condition; in this condition, (**Fwd**) output power reading on the display will be 0 (zero), whereas the **SET** bar, which you can control using the keys, provides a graphic display of the amount of power that will be delivered the moment you switch back to **Pwr ON** state.*

5.2.6 Changing the Power Good alarm threshold

Change Forward Power Good alarm setting **PgD** from the **Fnc** menu as desired (factory setting is 50%).

5.2.7 Setting equipment I²C address

Change the **IIC** address in the **MIX** (Miscellaneous) menu as desired (factory setting is 01).

5.2.8 How to enable Remote mode

If you wish to use the telemetry control feature, enable Remote control in the **Fnc** menu (see section 5.3.1 for details).



Note : *In the **Remote** mode, all local push-button controls except **Remote/Local** (for switching back to Local mode) are disabled . Operating parameter readings are available.*

5.3 Operation

- 1) Power on the amplifier (chap. 6.1) and ensure that the **ON** light turns on (chap. 6.1). Machine name should appear briefly on the display, quickly followed by forward and reflected power readings (Menu 1), provided that the amplifier is delivering output power.

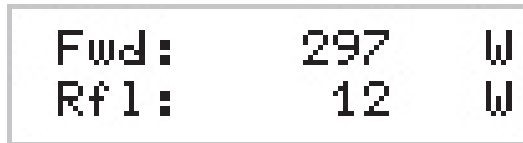

Menu 1

- 1b) To **modify power level setting**, hold down the **ENTER** button until opening the **power setup menu**.

The edit screen will look like this:



Menu 2

Next to **SET** indication, a bar provides a graphic display of preset output power. The filled portion of the bar is proportional to set power level.

<i>Example</i>		
100% output power	Full bar	≅ 300W in uscita (mod.PJ300C-LCD)
50% output power	Half bar	≅ 150W in uscita (mod.PJ300C-LCD)
25% output power	1/4 bar	≅ 75W in uscita (mod.PJ300C-LCD)

The bottom line provides instantaneous power reading (297W in this instance); press button to increase level, press to decrease it. When you have achieved the desired level, press **ENTER** to confirm and exit the default menu. Please note that the setting is stored automatically; in other words, if you press **ESC** or do not press any keys before the preset time times out, the latest power level set will be retained.



NOTE: This feature prevents the machine from delivering maximum power as soon as output is enabled from menu 4, or in the event the machine is already set to **ON** and energised.

- 2) Ensure that machine is not in a locked-out state. Press the **ESC** key (chap. 6.1) to call up the selection screen (Menu 3). Highlight **Fnc** and press **ENTER** to confirm (chap. 6.1) and access the appropriate menu (menu 4).

If **LOC** is set to **REMOTE** (machine remote control), move cursor to **LOC** and press **ENTER** (chap. 6.1); label will change to **LOCAL**, i.e. local control operation mode.

In the same menu, ensure that power limiting is disabled: if **PWR** is set to **OFF**, i.e. power output is disabled, move cursor to **PWR**. Press **ENTER** (chap. 6.1 - [9]) and label will switch to **ON**, i.e. power output enabled.

Press **ESC** (chap. 6.1) twice to go back to the **default menu** (menu 1).

- 3) Fine tune power setting from menu 2 (see description of item 1b) until achieving the desired value.



WARNING: Machine is capable of delivering more than rated output power (300 W); however, never exceed the specified power rating.



NOTE: Exciter drive power setting should never exceed 20 W, or it will trigger an Overdrive Alarm.



NOTE: If power is set to 0 W in the **edit mode**, the INTERLOCK OUT contact (chap. 6.2) trips and external exciter power is immediately inhibited.

Next, you can review all operating parameters of the machine through the management firmware.

Normally, the machine can run unattended. Any alarm condition is handled automatically by the safety system or is signalled by the LED indicators on the panel or by display messages.



NOTE: Standard factory settings are: output power set to upper limit (unless otherwise specified by customer) and **OFF**.

5.4 Management Firmware

The machine features an LCD with two lines by 16 characters that displays a set of menus. Figure 5.2 below provides an overview of machine menus.

The symbols listed below appear in the left portion of the display as appropriate:

- (Cursor) - Highlights selected (i.e. accessible) menu.
- ▶ (Filled arrow) - Editable parameter marker. This symbol appears in menus that take up more than two lines to aid browsing.
- ▶▶▶ (Three empty arrows) - Parameter is being edited.
- ▶ (Empty arrow) - Current line marker; the parameter in this line cannot be edited. This symbol appears in menus that take up more than two lines to aid browsing.

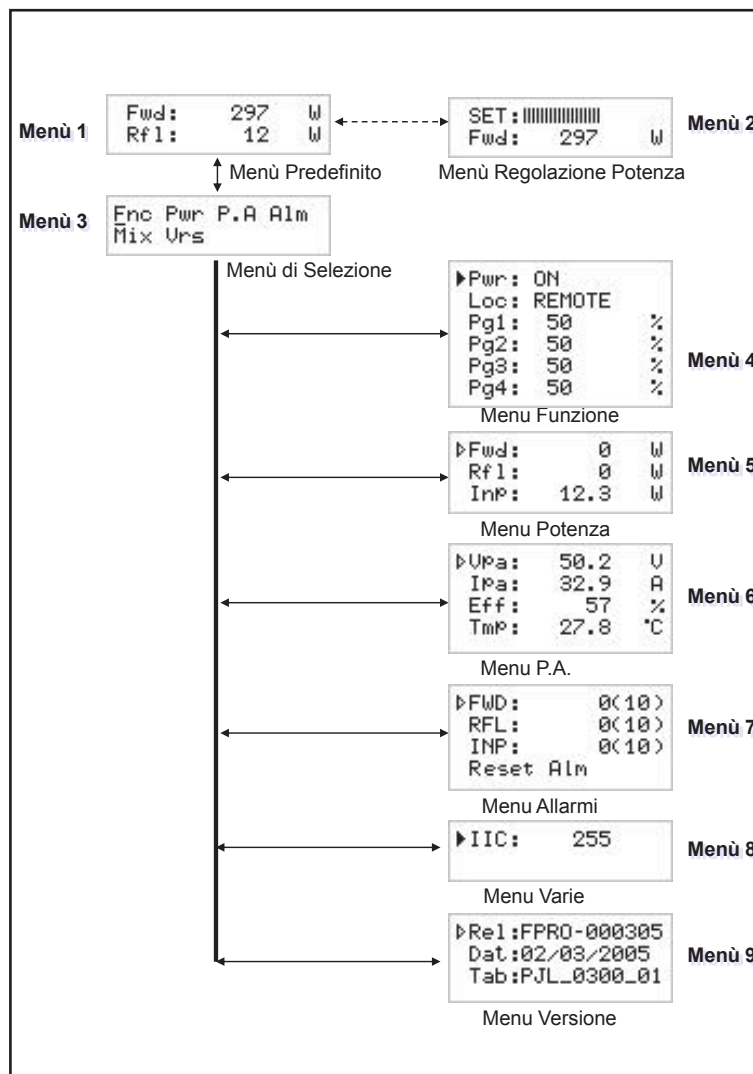
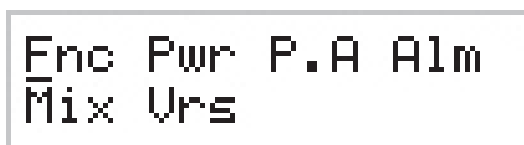

Figure 5.2

When the display is off, touching any key will turn on backlighting.

When the display is on, pressing the **ESC** button (chap. 6.1) from the **default menu** (menu 1) calls up the **selection screen** (menu 3), which gives access to all other menus:





Menu 3

To gain access to a submenu, select menu name (name is highlighted by cursor) using button  or  and press the **ENTER** button (chap. 6.1).

Press **ESC** again (chap. 6.1) to return to the **default menu** (menu 1).

5.4.1 Operation Menu (Fnc)

In this menu, you can set **power output** On/Off, toggle between “Local” or “Remote” control mode and set the **Forward Power Good (PgD)** threshold rate.

To edit an item, highlight the appropriate line using the UP and DOWN buttons and then press and hold the **ENTER** button (chap. 6.1) until the command is accepted. This way, Pwr setting is toggled between On and Off and Mod setting is toggled between “x1” and “x10”. To edit the Power Good rate, simply select item “PgD” and edit its value using buttons  and ; finally, press **ENTER** to confirm (chap. 6.1).

```

▶Pwr : ON
  Loc : REMOTE
  Pg1 : 50      %
  Pg2 : 50      %
  Pg3 : 50      %
  Pg4 : 50      %
    
```

Menu 4

- | | |
|-----|---|
| Pwr | Enables (ON) or disables (OFF) amplifier power output.. |
| Loc | Modifies machine operation. In the LOCAL mode, the machine can read and modify its operating parameters through the navigation keys and the management firmware, whereas all other sources are locked out. In the REMOTE mode, the machine can only read its operating parameters; parameters are modified based on the commands received from other connected telemetry systems. |
| Pg1 | Modifies Power Good threshold for forward power. The Power Good rate is a percent of equipment rated power (300W), not of forward output power. This means that this threshold set at 50% will give 150 W, respectively, regardless of set power level. The Power Good feature enables output power control and reporting. When output power drops below set Power Good threshold, the equipment changes the state of pin [9] of the DB25 “Remote” connector located on the rear panel. |
| Pg2 | Like Pg1, modifies a second Power Good threshold for forward power. When output power drops below set Power Good threshold, the equipment changes the state of pin [22] of the DB25 “Remote” connector located on the rear panel. |

- Pg3 Like Pg1, modifies Power Good threshold for reflected power. When output power drops below set Power Good threshold, the equipment changes the state of pin [18] of the DB25 “Remote” connector located on the rear panel.
- Pg4 Like Pg1, modifies a second Power Good threshold for reflected power.

5.4.2 Power Menu (Pwr)

This screen holds all readings related to machine output power:



P Fwd:	0	W
Rfl:	0	W
InP:	12.3	W

Menu 5

- Fwd Forward power reading.
- Rfl Reflected power reading.
- Inp Input power reading.

Note that these are readings, rather than settings, and cannot be edited (note the empty arrow). To change power setting, go to the **default menu** (menu 1) as outlined earlier.

5.4.3 Power Amplifier (P.A) Menu

This screen is made up of four lines that can be scrolled using the buttons  and , shows the readings relating to final power stage:

PUPa:	50.2	V
IPa:	32.9	A
Eff:	57	%
TmP:	27.8	°C

Menu 6

Note that these are readings, rather than settings, and cannot be edited (note the empty arrow).

VPA	Voltage supplied to amplifier module.
IPA	Current absorbed to amplifier module.
Eff	Efficiency based on ratio of forward power to amplifier module power in percent (FWD PWR/(Vpa x Ipa) %).
Tmp	Machine internal temperature.

5.4.4 Alarm Menu (Alm)

This menu shows any alarm conditions occurring during machine operation. Alarm thresholds are preset at the factory.

```

▶FWD:      0(10)
RFL:      0(10)
INP:      0(10)
Reset Alm
    
```

Menu 7

FWD	Counter of alarm conditions triggered by forward power.
RFL	Counter of alarm conditions triggered by reflected power.
INP	Counter of alarm conditions triggered by input power.
Reset Alm	Alarm counter reset.

Alarm conditions are numbered from 1 to 10 and reflect the following situations: forward output power too high, reflected output power too high and input power too high.

Alarm monitoring cycle is as follows: when an alarm condition is detected, alarm counter increases by 1 unit, machine goes into lock-out state and the display shows the cause for the stop (chap. 5.3.4.1). After 15 seconds, the machine attempts to re-start; if a new alarm condition is detected, cycle is repeated over and over again up to 10 times maximum.

If machine re-starts successfully, all alarm counters are reset after 30 minutes' regular operation. After 10 alarm conditions triggered by the same cause, the machine goes into fault lock-out mode, a lock-out mode warning appears on the display and the "FAULT" LED turns on (chap. 6.1).

After the alarm condition has been rectified, the counter can be reset by highlighting "Reset Alm" and holding down the **ENTER** key for some time (chap. 6.1).

5.4.4.1 Alarms and Faults

There are three types of alarms that can cause a machine lock-out and trigger a “FAULT/LOCK” indication. **When any one of the three alarm thresholds is exceeded, the system will automatically switch to the warning screen (even though the user is browsing system menus) and the following messages are displayed:**

1. Over Forward Power

Forward power threshold exceeded.



```
!! ATTENTION !!  
OVER FWD Power
```

Alarm 1

2. Over Reflected Power

Reflected power threshold exceeded.



```
!! ATTENTION !!  
OVER RFL Power
```

Alarm 2

3. Over Input Power

Input power threshold exceeded.



```
!! ATTENTION !!  
OVER INP Power
```

Alarm 3

Monitoring cycle is as follows:

- An alarm condition occurs;
- Alarm is displayed and device is locked out for 15 sec.;
- Operating conditions are restored;
- Verification.

Upon reaching the 10 cycle limit, a “FAULT” indication is triggered and the device goes into lock-out mode; the appropriate LED turns on (figure 6.1) and this screen is displayed:

I. Over Forward Power

Forward power alarm display.

```

!! HALTED FOR !!
OVER FWD Power
    
```

Stop 1

II. Over Reflected Power

Reflected power alarm display.

```

!! HALTED FOR !!
OVER RFL Power
    
```

Stop 2

III. Over Input Power

Input power alarm display.

```

!! HALTED FOR !!
OVER INP Power
    
```

Stop 3

Once the machine goes into “FAULT” mode, it will no longer attempt to re-start; choose the appropriate reset procedure according to current machine setting:

- Machine set to LOCAL control mode - press “Reset Alm” in the alarm menu (menu 7) or power off and back on again using the POWER switch (chap. 6.2).
- Machine set to REMOTE control mode - power off and back on again sending the appropriate command via the DB15 connector (chap. 6.3.2 - item [14] and [15]).

There is a fourth alarm that does not trigger a “FAULT” condition, but allows some time until correct operating conditions are restored. When the temperature alarm threshold is exceeded (about 85°C), the following screen appears:

4. Over Temperature

Temperature power threshold exceeded.

```
!! ATTENTION !!
OVER TEMPERATURE
```

Alarm 4

5.4.5 Miscellaneous Menu (Mix)

This menu lets you set machine address in an I²C bus serial connection:

```
▶ IIC:      255
```

Menu 8

IIC I²C address setting. The I²C network address becomes significant when the exciter is connected in an RVR transmission system that uses this protocol. Do not change it unless strictly required.

5.4.6 Version Menu (Vrs)

This screen holds machine version/release information:

```
▶ Rel:FPR0-000305
  Dat:02/03/2005
  Tab:PJL_0300_01
```

Menu 9

Note that these are readings, rather than settings, and cannot be edited (note the empty arrow).

Rel	Firmware release information.
Dat	Release date.
Tab	Shows table loaded in the memory.

6. Identification and Access to the Modules

6.1 Identification of the Modules

The **PJ300C-LCD** is made up of various modules linked to each other through connectors so as to make maintenance and any required module replacement easier.

The figure below shows the equipment upper view with the various components pointed out.

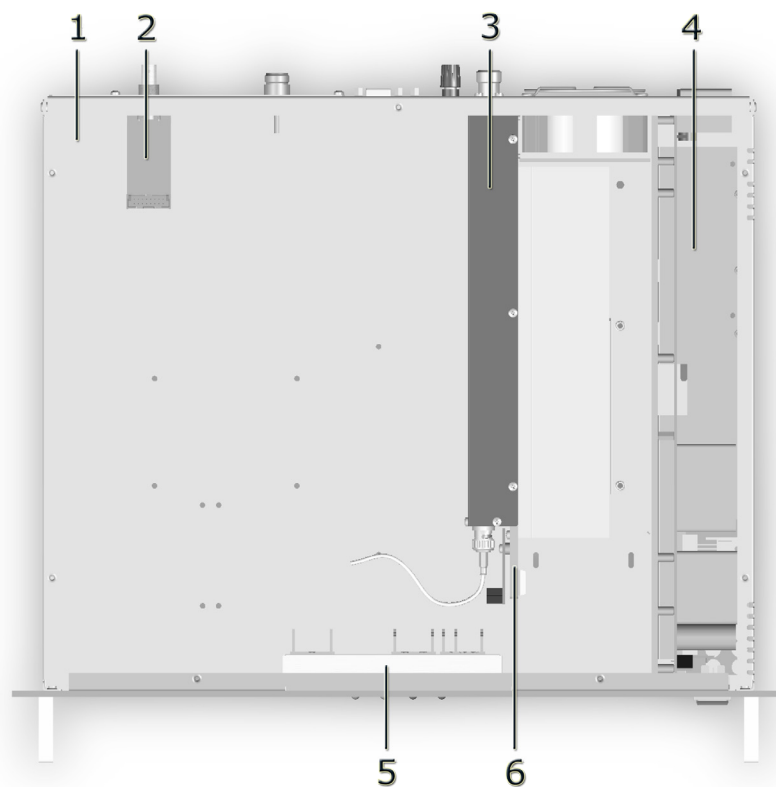

figure 8.1

- [1] Telemetry Card
- [2] Interlock Output Interface Card
- [3] Power Amplifier
- [4] Power Supply
- [5] Panel Card
- [6] Control Card

7. Working Principles

7.1 Panel Board

The panel board contains the microcontroller (PIC18F452) that implements the equipment control software, the display and the other components needed to interface with the user.

The board is connected with the other machine modules, both for power supply distribution and for the control and measures.

7.2 Telemetry Board

This board is designed to inform the user of the equipment operation state. All input and output signals are available on the DB25 connector.

The same board also features the "INTERLOCK" BNC connector for disabling the device. By grounding the central pin, the output power is reduced to zero until the connection is removed.

When an R.V.R. amplifier is used, this connector is linked to the power amplifier REMOTE or INTERLOCK by means of a BNC-BNC connection. In case of amplifier faults, the central conductor is grounded thus forcing the machine to enter in stand-by mode.

7.3 Power Supply

The **PJ300C-LCD** power supply unit is a switching-type unit whose +50 V main stabilizers for generating continuous +5 V, +18 V and -18 V voltages for supplying the other equipment circuits. Note that the power supply is a "direct from mains" type, or rather it is without a transformer, and it can be connected to any voltage between 90 and 260 V without any adjustments or manual settings.

7.4 Power Amplifier

The final power stage is enclosed in a totally shielded metal container fastened in the centre of the device.

The RF signal coming from input power connectors, attenuate of 6 dB (for better input return loss), measured by directional coupler and then sent to the final stage that sees to its final amplifications up to 300W.

In addition to the actual RF amplification, this circuit carries out the following functions:

- Control of the power level in output, depending on the setting
- Reduction of the power supplied when in presence of high-level reflected power

- Measures of the forward and reflected power by means of directional couplers
- Measures of the current absorbed by the power amplifier
- Measures of the temperature
- Low-pass filtering of the RF signal in output

This board also features an RF sampling of approximately -50dB RF with respect to the output, which is available on a BNC connector below the transmitter output connector. This sample is useful for verifying the characteristics of the carrier, but not for verifying those of the upper harmonics.

7.3 Control Board

The main function of this board is to check and correct the MOSFET polarization voltage of the RF amplifier section.

It also provides the measurement of the absorbed current.

If no alarms are present, the voltage is adjusted only depending on the set output power, with a feedback mechanism based on the reading of the power really delivered (AGC).

The voltage is also affected by other factors, such as:

- Excess of reflected power.
- External AGC signals (Ext. AGC FWD, Ext. AGC RFL).
- Excess of temperature.
- Excess of absorbed current from the RF module.

This page was intentionally left blank

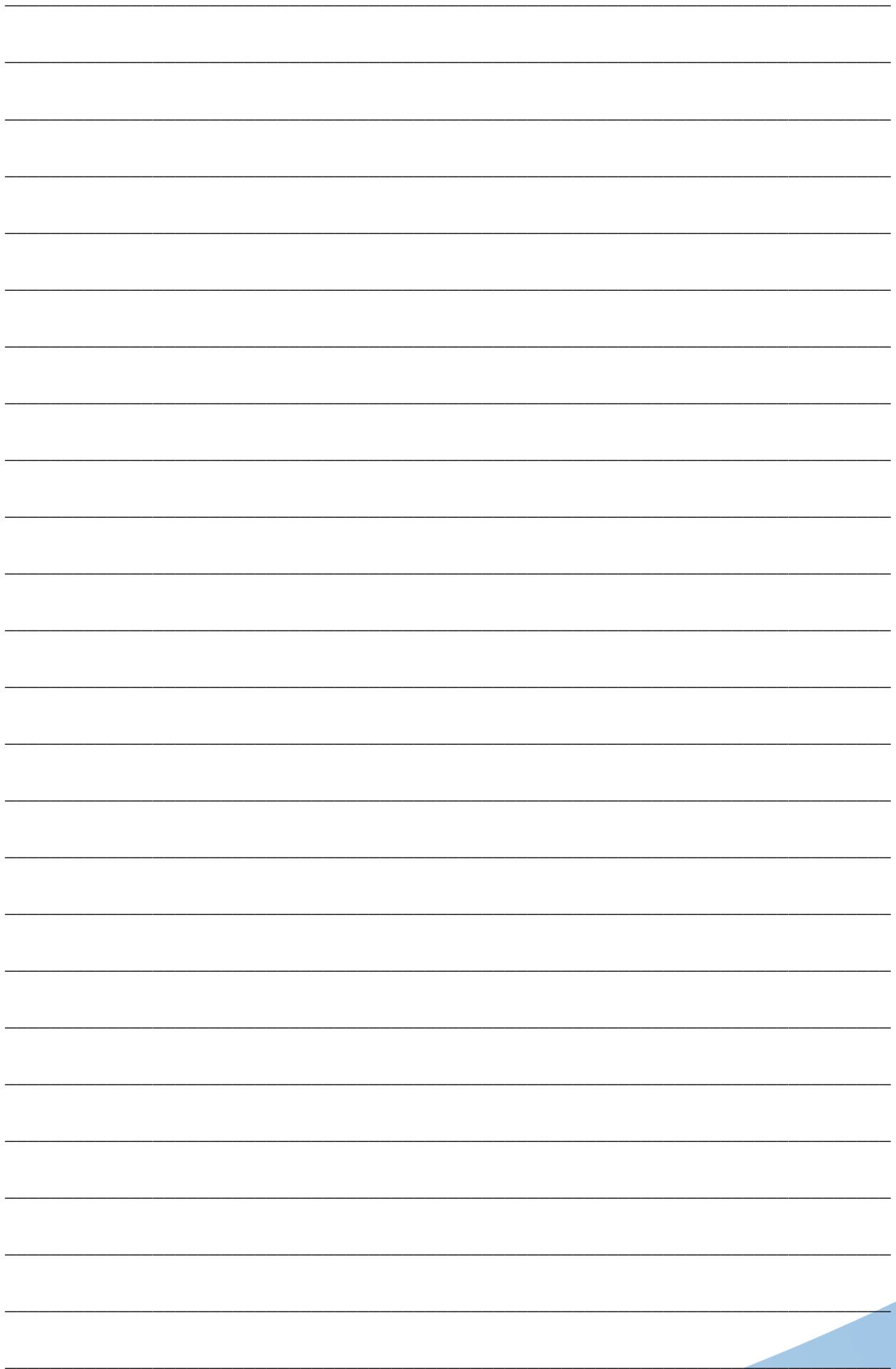



R.V.R. Elettronica S.p.A.

Via del Fonditore, 2 / 2c

Zona Industriale Roveri · 40138 Bologna · Italy

Phone: +39 051 6010506 · Fax: +39 051 6011104

e-mail: info@rvr.it · web: <http://www.rvr.it>

ISO 9001:2000 certified since 2000



The RVR Logo, and others referenced RVR products and services are trademarks of RVR Elettronica S.p.A. in Italy, other countries or both. RVR ® 1998 all rights reserved.
All other trademarks, trade names or logos used are property of their respective owners.